



Service Manual

Lexmark™ E23x, E33x

4505-100

4505-200

4505-300

4505-310

4505-400

4505-410

- ***Table of Contents***
- ***Start Diagnostics***
- ***Safety and Notices***
- ***Trademarks***
- ***Index***

LEXMARK™

Lexmark and Lexmark with diamond design are trademarks of Lexmark International, Inc., registered in the United States and/or other countries.

Edition: June 2004

The following paragraph does not apply to any country where such provisions are inconsistent with local law: LEXMARK INTERNATIONAL, INC. PROVIDES THIS PUBLICATION "AS IS" WITHOUT WARRANTY OF ANY KIND, EITHER EXPRESS OR IMPLIED, INCLUDING, BUT NOT LIMITED TO, THE IMPLIED WARRANTIES OF MERCHANTABILITY OR FITNESS FOR A PARTICULAR PURPOSE. Some states do not allow disclaimer of express or implied warranties in certain transactions; therefore, this statement may not apply to you.

This publication could include technical inaccuracies or typographical errors. Changes are periodically made to the information herein; these changes will be incorporated in later editions. Improvements or changes in the products or the programs described may be made at any time. Comments may be addressed to Lexmark International, Inc., Department D22A/032-2, 740 West New Circle Road, Lexington, Kentucky 40550, U.S.A or e-mail at ServiceInfoAndTraining@Lexmark.com. Lexmark may use or distribute any of the information you supply in any way it believes appropriate without incurring any obligation to you. You can purchase additional copies of publications related to this product by calling 1-800-553-9727. In other countries, contact your point of purchase.

References in this publication to products, programs, or services do not imply that the manufacturer intends to make these available in all countries in which it operates. Any reference to a product, program, or service is not intended to state or imply that only that product, program, or service may be used. Any functionally equivalent product, program, or service that does not infringe any existing intellectual property right may be used instead. Evaluation and verification of operation in conjunction with other products, programs, or services, except those expressly designated by the manufacturer, are the user's responsibility.

Lexmark, Lexmark with diamond design, and MarkVision are trademarks of Lexmark International, Inc., registered in the United States and/or other countries.

Optra Forms is a trademark of Lexmark International, Inc.

PCL[®] is a registered trademark of the Hewlett-Packard Company.

PostScript[®] is a registered trademark of Adobe Systems Incorporated.

Other trademarks are the property of their respective owners.

© 2004 Lexmark International, Inc.

All rights reserved.

UNITED STATES GOVERNMENT RIGHTS

This software and any accompanying documentation provided under this agreement are commercial computer software and documentation developed exclusively at private expense.

U.S.A. P/N 12G9399

Table of contents

Laser notices	vii
Safety information	xv
Preface	xx
Definitions	xx
General information	1-1
Overview of the operator panel	1-3
Paper jams—how to clear	1-4
Tips on preventing jams	1-5
Tools	1-6
Types of print media	1-7
Abbreviations	1-8
Diagnostic information	2-1
Start	2-1
POST (power-on self test)	2-1
Overview of the operator panel	2-2
Understanding the operator panel lights	2-3
Common light sequences	2-3
Secondary errors.	2-6
Operator panel codes	2-8
Primary codes.	2-8
Secondary error codes	2-19
Service information with secondary and tertiary light patterns	2-29
Secondary error codes	2-30
Tertiary service error codes	2-31
Symptom tables	2-44
POST symptom table	2-44
Printer symptom table	2-45
Service checks	2-47
Cold fuser service check	2-47
Cooling fan service check	2-48
Controller card service check	2-49
Cover interlock switch service check	2-51
Dead machine service check	2-52
Fuser service check	2-53
Hot fuser service check.	2-56
LVPS/HVPS service check	2-57
Main motor service check	2-58

Operator panel service check	2-59
Printhead service check	2-61
Paper feed service checks	2-61
Parallel port service check	2-65
Print quality service checks	2-66
Using print quality test pages	2-66
Transfer roll service check	2-79
Diagnostic aids	3-1
Configuration and diagnostic groups	3-1
Configuration	3-1
Diagnostic	3-1
Power-On operations	3-2
Configuration menu selections	3-6
Diagnostics menu selections	3-12
Repair information	4-1
Removals	4-1
Covers	4-2
Fan removal	4-6
Feed rollers (auto comp tires) removal	4-7
Fuser idle gear links removal	4-7
Fuser power cable removal	4-8
Fuser removal	4-8
Input roller clutch and lever removal (ACM clutch CBM)	4-9
Input sensor #1 removal	4-9
Input sensor #2 (manual) removal	4-10
LVPS / HVPS card assembly removal	4-10
LVPS / HVPS to controller card cable removal	4-11
Manual feed clutch assembly removal	4-11
Operator panel removal	4-11
Paper exit guide assembly removal	4-12
Printhead removal	4-12
Toner level sensor cable removal	4-12
Toner level sensor removal	4-13
Transfer roll removal	4-13
Transport motor cable removal	4-14
Connector locations	5-1
Front and rear views	5-1
Power supply board	5-2
Controller board	5-3
Wiring diagram	5-4

Preventive maintenance	6-1
Parts catalog	7-1
How to use this parts catalog	7-1
Index	I-1
Part number index	I-5

Laser notices

Laser notice

The printer is certified in the U.S. to conform to the requirements of DHHS 21 CFR Subchapter J for Class I (1) laser products, and elsewhere is certified as a Class I laser product conforming to the requirements of IEC 60825-1.

Class I laser products are not considered to be hazardous. The printer contains internally a Class IIIb (3b) laser that is nominally a 5 milliwatt gallium arsenide laser operating in the wavelength region of 770-795 nanometers. The laser system and printer are designed so there is never any human access to laser radiation above a Class I level during normal operation, user maintenance, or prescribed service condition.

Laser

Der Drucker erfüllt gemäß amtlicher Bestätigung der USA die Anforderungen der Bestimmung DHHS (Department of Health and Human Services) 21 CFR Teil J für Laserprodukte der Klasse I (1). In anderen Ländern gilt der Drucker als Laserprodukt der Klasse I, der die Anforderungen der IEC (International Electrotechnical Commission) 60825-1 gemäß amtlicher Bestätigung erfüllt.

Laserprodukte der Klasse I gelten als unschädlich. Im Inneren des Druckers befindet sich ein Laser der Klasse IIIb (3b), bei dem es sich um einen Galliumarsenlaser mit 5 Milliwatt handelt, der Wellen der Länge 770-795 Nanometer ausstrahlt. Das Lasersystem und der Drucker sind so konzipiert, daß im Normalbetrieb, bei der Wartung durch den Benutzer oder bei ordnungsgemäßer Wartung durch den Kundendienst Laserbestrahlung, die die Klasse I übersteigen würde, Menschen keinesfalls erreicht.

Avis relatif à l'utilisation de laser

Pour les Etats-Unis : cette imprimante est certifiée conforme aux provisions DHHS 21 CFR alinéa J concernant les produits laser de Classe I (1). Pour les autres pays : cette imprimante répond aux normes IEC 60825-1 relatives aux produits laser de Classe I.

Les produits laser de Classe I sont considérés comme des produits non dangereux. Cette imprimante est équipée d'un laser de Classe IIIb (3b) (arséniure de gallium d'une puissance nominale de 5 milliwatts) émettant sur des longueurs d'onde comprises entre 770 et 795 nanomètres. L'imprimante et son système laser sont conçus pour impossible, dans des conditions normales d'utilisation, d'entretien par l'utilisateur ou de révision, l'exposition à des rayonnements laser supérieurs à des rayonnements de Classe I.

Avvertenze sui prodotti laser

Questa stampante è certificata negli Stati Uniti per essere conforme ai requisiti del DHHS 21 CFR Sottocapitolo J per i prodotti laser di classe 1 ed è certificata negli altri Paesi come prodotto laser di classe 1 conforme ai requisiti della norma CEI 60825-1.

I prodotti laser di classe non sono considerati pericolosi. La stampante contiene al suo interno un laser di classe IIIb (3b) all'arseniuro di gallio della potenza di 5mW che opera sulla lunghezza d'onda compresa tra 770 e 795 nanometri. Il sistema laser e la stampante sono stati progettati in modo tale che le persone a contatto con la stampante, durante il normale funzionamento, le operazioni di servizio o quelle di assistenza tecnica, non ricevano radiazioni laser superiori al livello della classe 1.

Avisos sobre el láser

Se certifica que, en los EE.UU., esta impresora cumple los requisitos para los productos láser de Clase I (1) establecidos en el subcapítulo J de la norma CFR 21 del DHHS (Departamento de Sanidad y Servicios) y, en los demás países, reúne todas las condiciones expuestas en la norma IEC 60825-1 para productos láser de Clase I (1).

Los productos láser de Clase I no se consideran peligrosos. La impresora contiene en su interior un láser de Clase IIIb (3b) de arseniuro de galio de funcionamiento nominal a 5 milivatios en una longitud de onda de 770 a 795 nanómetros. El sistema láser y la impresora están diseñados de forma que ninguna persona pueda verse afectada por ningún tipo de radiación láser superior al nivel de la Clase I durante su uso normal, el mantenimiento realizado por el usuario o cualquier otra situación de servicio técnico.

Declaração sobre Laser

A impressora está certificada nos E.U.A. em conformidade com os requisitos da regulamentação DHHS 21 CFR Subcapítulo J para a Classe I (1) de produtos laser. Em outros locais, está certificada como um produto laser da Classe I, em conformidade com os requisitos da norma IEC 60825-1.

Os produtos laser da Classe I não são considerados perigosos. Internamente, a impressora contém um produto laser da Classe IIIb (3b), designado laser de arseneto de potássio, de 5 milliwatts, operando numa faixa de comprimento de onda entre 770 e 795 nanómetros. O sistema e a impressora laser foram concebidos de forma a nunca existir qualquer possibilidade de acesso humano a radiação laser superior a um nível de Classe I durante a operação normal, a manutenção feita pelo utilizador ou condições de assistência prescritas.

Huomautus laserlaitteesta

Tämä kirjoitin on Yhdysvalloissa luokan I (1) laserlaitteiden DHHS 21 CFR Subchapter J -määrityksen mukainen ja muualla luokan I laserlaitteiden IEC 60825-1 -määrityksen mukainen.

Luokan I laserlaitteiden ei katsota olevan vaarallisia käyttäjälle. Kirjoittimessa on sisäinen luokan IIIb (3b) 5 milliwatin galliumarsenidilaser, joka toimii aaltoalueella 770 - 795 nanometriä. Laserjärjestelmä ja kirjoitin on suunniteltu siten, että käyttäjä ei altistu luokan I määrityksiä voimakkaammalle säteilylle kirjoittimen normaalin toiminnan, käyttäjän tekemien huoltotoimien tai muiden huoltotoimien yhteydessä.

VARO! Avattaessa ja suojalukitus ohitettaessa olet alttiina näkymättömälle lasersäteilylle. Älä katso säteeseen.

WARNING! Osynlig laserstrålning när denna del är öppnad och spärren är urkopplad. Betrakta ej strålen.

Laser-notis

Denna skrivare är i USA certifierad att motsvara kraven i DHHS 21 CFR, underparagraf J för laserprodukter av Klass I (1). I andra länder uppfyller skrivaren kraven för laserprodukter av Klass I enligt kraven i IEC 60825-1.

Laserprodukter i Klass I anses ej hälsovådliga. Skrivaren har en inbyggd laser av Klass IIIb (3b) som består av en laserenhet av gallium-arsenid på 5 milliwatt som arbetar i våglängdsområdet 770-795 nanometer. Lasersystemet och skrivaren är utformade så att det aldrig finns risk för att någon person utsätts för laserstrålning över Klass I-nivå vid normal användning, underhåll som utförs av användaren eller annan föreskriven serviceåtgärd.

Laser-melding

Skriveren er godkjent i USA etter kravene i DHHS 21 CFR, underkapittel J, for klasse I (1) laserprodukter, og er i andre land godkjent som et Klasse I-laserprodukt i samsvar med kravene i IEC 60825-1.

Klasse I-laserprodukter er ikke å betrakte som farlige. Skriveren inneholder internt en klasse IIIb (3b)-laser, som består av en gallium-arsenlaserenhet som avgir stråling i bølgelengdeområdet 770-795 nanometer. Lasersystemet og skriveren er utformet slik at personer aldri utsettes for laserstråling ut over klasse I-nivå under vanlig bruk, vedlikehold som utføres av brukeren, eller foreskrevne serviceoperasjoner.

Avís sobre el Làser

Segons ha estat certificat als Estats Units, aquesta impressora compleix els requisits de DHHS 21 CFR, apartat J, pels productes làser de classe I (1), i segons ha estat certificat en altres llocs, és un producte làser de classe I que compleix els requisits d'IEC 60825-1.

Els productes làser de classe I no es consideren perillosos. Aquesta impressora conté un làser de classe IIIb (3b) d'arseniür de gal.li, nominalment de 5 mil.liwats, i funciona a la regió de longitud d'ona de 770-795 nanòmetres. El sistema làser i la impressora han sigut concebuts de manera que mai hi hagi exposició a la radiació làser per sobre d'un nivell de classe I durant una operació normal, durant les tasques de manteniment d'usuari ni durant els serveis que satisfacin les condicions prescrites.

Japanese Laser Notice

レーザーに関するお知らせ

このプリンターは、米国ではDHHS 21 CFRサブチャプターJのクラスI（1）の基準を満たしたレーザー製品であることが証明されています。また米国以外ではIEC 825の基準を満たしたクラスIのレーザー製品であることが証明されています。

クラスIのレーザー製品には危険性はないと考えられています。このプリンターはクラスIII b（3 b）のレーザーを内蔵しています。このレーザーは、波長が770 ～ 795ナノメートルの範囲で、通常5ミリワットのガリウム砒化物を放射するレーザーです。このレーザーシステムとプリンターは、通常の操作、ユーザのメンテナンス、規定された修理においては、人体がクラスIのレベル以上のレーザー放射に晒されることのないよう設計されています。

Chinese Laser Notice

注意：

本打印机被美国认证合乎 DHHS 21 CFR Subchapter I 对分类 I (1) 激光产品的标准，而在其他地区则被认证合乎 IEC 825 的标准。

分类 I 激光产品一般认为不具危险性，本打印机内部含有分类 IIIb (3b) 的激光，在操作过程中会产生 5 毫瓦含镓及砷的微量激光，其波长范围在 770-795 nm 之间。本激光系统及打印机的设计，在一般操作、使用者维护或规定内的维修情况下，不会使人体接触分类 I 以上等级的辐射。

Korean Laser Notice

본프린터는 1등급 레이저 제품들에 대한 DHHS 21 CFR Subchapter 3의 규정을 준수하고 있음을 미국에서 인증받았으며, 그외의 나라에서도 IEC 825 규정을 준수하는 1등급 레이저 제품으로서 인증을 받았습니다.

1등급 레이저 제품들은 안전한 것으로 간주됩니다. 본 프린터는 5 밀리와트 가솔륨 아르세나이드 레이저로서 770-795 나노미터의 파장대에서 활동하는 Class III (3b) 레이저를 내부에 갖고 있습니다. 본 레이저 시스템과 프린터는 정상 작동 중이나 유지 보수 중 또는 규정된 서비스 상태에서 상기의 Class I 수준의 레이저 방출에 사람이 절대 접근할 수 없도록 설계되어 있습니다.

Safety information

- The safety of this product is based on testing and approvals of the original design and specific components. The manufacturer is not responsible for safety in the event of use of unauthorized replacement parts.
- The maintenance information for this product has been prepared for use by a professional service person and is not intended to be used by others.
- There may be an increased risk of electric shock and personal injury during disassembly and servicing of this product. Professional service personnel should understand this and take necessary precautions.
-  **CAUTION:** When you see this symbol, there is a danger from hazardous voltage in the area of the product where you are working. Unplug the product before you begin, or use caution if the product must receive power in order to perform the task.

Consignes de sécurité

- La sécurité de ce produit repose sur des tests et des agréments portant sur sa conception d'origine et sur des composants particuliers. Le fabricant n'assume aucune responsabilité concernant la sécurité en cas d'utilisation de pièces de rechange non agréées.
- Les consignes d'entretien et de réparation de ce produit s'adressent uniquement à un personnel de maintenance qualifié.
- Le démontage et l'entretien de ce produit pouvant présenter certains risques électriques, le personnel d'entretien qualifié devra prendre toutes les précautions nécessaires.
-  **ATTENTION :** Ce symbole indique la présence d'une tension dangereuse dans la partie du produit sur laquelle vous travaillez. Débranchez le produit avant de commencer ou faites preuve de vigilance si l'exécution de la tâche exige que le produit reste sous tension.

Norme di sicurezza

- La sicurezza del prodotto si basa sui test e sull'approvazione del progetto originale e dei componenti specifici. Il produttore non è responsabile per la sicurezza in caso di sostituzione non autorizzata delle parti.
- Le informazioni riguardanti la manutenzione di questo prodotto sono indirizzate soltanto al personale di assistenza autorizzato.
- Durante lo smontaggio e la manutenzione di questo prodotto, il rischio di subire scosse elettriche e danni alla persona è più elevato. Il personale di assistenza autorizzato deve, quindi, adottare le precauzioni necessarie.
-  **ATTENZIONE:** Questo simbolo indica la presenza di tensione pericolosa nell'area del prodotto. Scollegare il prodotto prima di iniziare o usare cautela se il prodotto deve essere alimentato per eseguire l'intervento.

Sicherheitshinweise

- Die Sicherheit dieses Produkts basiert auf Tests und Zulassungen des ursprünglichen Modells und bestimmter Bauteile. Bei Verwendung nicht genehmigter Ersatzteile wird vom Hersteller keine Verantwortung oder Haftung für die Sicherheit übernommen.
- Die Wartungsinformationen für dieses Produkt sind ausschließlich für die Verwendung durch einen Wartungsfachmann bestimmt.
- Während des Auseinandernehmens und der Wartung des Geräts besteht ein zusätzliches Risiko eines elektrischen Schlags und körperlicher Verletzung. Das zuständige Fachpersonal sollte entsprechende Vorsichtsmaßnahmen treffen.
-  **ACHTUNG:** Dieses Symbol weist auf eine gefährliche elektrische Spannung hin, die in diesem Bereich des Produkts auftreten kann. Ziehen Sie vor den Arbeiten am Gerät den Netzstecker des Geräts, bzw. arbeiten Sie mit großer Vorsicht, wenn das Produkt für die Ausführung der Arbeiten an den Strom angeschlossen sein muß.

Pautas de Seguridad

- La seguridad de este producto se basa en pruebas y aprobaciones del diseño original y componentes específicos. El fabricante no es responsable de la seguridad en caso de uso de piezas de repuesto no autorizadas.
- La información sobre el mantenimiento de este producto está dirigida exclusivamente al personal cualificado de mantenimiento.
- Existe mayor riesgo de descarga eléctrica y de daños personales durante el desmontaje y la reparación de la máquina. El personal cualificado debe ser consciente de este peligro y tomar las precauciones necesarias.
-  **PRECAUCIÓN:** este símbolo indica que el voltaje de la parte del equipo con la que está trabajando es peligroso. Antes de empezar, desenchufe el equipo o tenga cuidado si, para trabajar con él, debe conectarlo.

Informações de Segurança

- A segurança deste produto baseia-se em testes e aprovações do modelo original e de componentes específicos. O fabricante não é responsável pela segurança, no caso de uso de peças de substituição não autorizadas.
- As informações de segurança relativas a este produto destinam-se a profissionais destes serviços e não devem ser utilizadas por outras pessoas.
- Risco de choques eléctricos e ferimentos graves durante a desmontagem e manutenção deste produto. Os profissionais destes serviços devem estar avisados deste facto e tomar os cuidados necessários.
-  **CUIDADO:** Quando vir este símbolo, existe a possível presença de uma potencial tensão perigosa na zona do produto em que está a trabalhar. Antes de começar, desligue o produto da tomada eléctrica ou seja cuidadoso caso o produto tenha de estar ligado à corrente eléctrica para realizar a tarefa necessária.

Informació de Seguretat

- La seguretat d'aquest producte es basa en l'avaluació i aprovació del disseny original i els components específics. El fabricant no es fa responsable de les qüestions de seguretat si s'utilitzen peces de recanvi no autoritzades.
- La informació pel manteniment d'aquest producte està orientada exclusivament a professionals i no està destinada a ningú que no ho sigui.
- El risc de xoc elèctric i de danys personals pot augmentar durant el procés de desmuntatge i de servei d'aquest producte. El personal professional ha d'estar-ne assabentat i prendre les mesures convenients.
-  **PRECAUCIÓ:** aquest símbol indica que el voltatge de la part de l'equip amb la qual esteu treballant és perillós. Abans de començar, desendolleu l'equip o extremeu les precaucions si, per treballar amb l'equip, l'heu de connectar.

안전 사항

- 본 제품은 원래 설계 및 특정 구성품에 대한 테스트 결과로 안정성이 입증된 것입니다. 따라서 무허가 교체부품을 사용하는 경우에는 제조업체에서 안전에 대한 책임을 지지 않습니다.
- 본 제품에 관한 유지 보수 설명서는 전문 서비스 기술자용으로 작성된 것이므로, 비전문가는 사용할 수 없습니다.
- 본 제품을 해체하거나 정비할 경우, 전기적인 충격을 받거나 상처를 입을 위험이 커집니다. 전문 서비스 기술자는 이 사실을 숙지하고, 필요한 예방 조치를 취하도록 하십시오.
-  **주의:** 이 표시는 해당영역에서 고압전류가 흐른다는 위험 표시입니다. 시작전에 플러그를 뽑으시거나, 주의를 기울여 주시기 바랍니다.

专业服务人员对此点必须有所了解，并采取必要的预防措施。



切记：当您看到此符号时，说明在您工作的产品区域有危险电压的存在。请在开始操作前拔掉产品的电源线，或者在产品必须使用电源来执行任务时，小心从事。

Preface

This manual contains maintenance procedures for service personnel. It is divided into the following chapters:

1. **General information** contains a general description of the printer and the maintenance approach used to repair it. Special tools and test equipment are listed in this chapter, as well as general environmental and safety instructions.
2. **Diagnostic information** contains an error indicator table, symptom tables, and service checks used to isolate failing field replaceable units (FRUs (field replaceable unit)).
3. **Diagnostic aids** contains tests and checks used to locate or repeat symptoms of printer problems.
4. **Repair information** provides instructions for making printer adjustments and removing and installing field replaceable units (FRUs).
5. **Connector locations** uses illustrations to identify the connector locations and test points on the printer.
6. **Preventive maintenance** contains the lubrication specifications and recommendations to prevent problems.
7. **Parts catalog** contains illustrations and part numbers for individual FRUs.

Definitions

Note: A note provides additional information.

Warning: A warning identifies something that might damage the product hardware or software.

CAUTION: A caution identifies something that might cause a servicer harm.



CAUTION: When you see this symbol, there is a danger from hazardous voltage in the area of the product where you are working. Unplug the product before you begin, or use caution if the product must receive power in order to perform the task.

1. General information

The Lexmark™ E23x, E33x printers are monochrome laser printers designed for single users or small workgroups. There are four models:

- E230, 8MB memory standard, a USB (universal serial bus) port, a parallel port, and prints 18 pages per minute.

Note: The optional 550-sheet tray is not supported.

- E232, 16MB of memory standard, a parallel port, a USB port, and prints 22 pages per minute.
- E330, 32MB of memory standard, a parallel port, a USB port, and prints 27 pages per minute.
- E332n, 32MB of memory standard, an integrated Ethernet adapter, a parallel port, a USB port, and prints 27 pages per minute.
- E234, 32MB of memory standard, a parallel port, a USB port, and prints 25 pages per minute.
- E234n, 32MB of memory standard, an integrated Ethernet adapter, a parallel port, a USB port, and prints 27 pages per minute.

4505





The differences between the models are listed in the following table.

Item	4505-100 Lexmark E230	4505-200 Lexmark E232	4505-300 Lexmark E330	4505-310 Lexmark E332n
Base memory	8MB	16MB	32MB	
Maximum memory	8MB	80MB	160MB	
Paper inputs	<ul style="list-style-type: none"> • 250-sheet tray • Single-sheet manual feeder 	<ul style="list-style-type: none"> • 250-sheet tray • Single-sheet manual feeder • Optional 550-sheet drawer 		
Emulations	HBP (host-based printing), PCL (printer control language) 5e, and Windows/Macintosh/Linux compatibility	HBP, PCL 6, and Windows/Macintosh/Linux compatibility	HBP, PostScript 3, PCL 6, PPDS (personal printer data stream) and Windows/Macintosh/Linux compatibility	
Connectivity	USB and Parallel			USB, Parallel, and 10/100 Base-TX Ethernet
Toner cartridge yield	1,500 pages* (starter toner cartridge)		2,500 pages	
Photoconductor kit yield	30,000 pages*			
* Yield based on approximately 5% coverage of pages.				

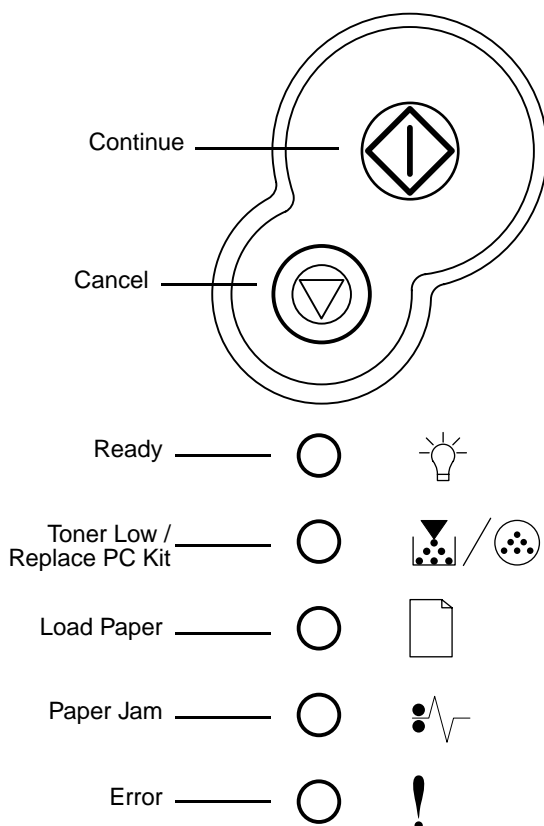

Overview of the operator panel

The operator panel has six lights and two buttons. See **“Operator panel codes” on page 2-8** for more information.



- Press and release  to resume printing.
- Press and release  twice quickly to display a secondary error code following an error.
- Press and release  to cancel the job currently printing.
- Press and hold  until all of the lights come on to reset the printer.

Paper jams—how to clear

When a paper jam occurs, the printer stops operating and the operator panel's  and  lights come on. Press and release  twice quickly to display the specific secondary error paper jam light sequence. See “**Secondary errors**” on page 2-6 for more information.

We recommend the entire paper path be cleared when a paper jam occurs.

To clear a paper jam:

1. If the paper is feeding from a tray, remove the tray, and then remove any jams.
2. Open the front cover and remove the print cartridge assembly.
3. Remove any jams located in the area behind the print cartridge assembly.
4. Lift the flap at the front of the printer and remove any jams located beneath the flap.
5. Open the rear exit and remove any jams.
6. After you have cleared the jams, reinstall the print cartridge assembly, make sure all printer covers and trays are closed, and then press the  button to resume printing.

Note: Pages caught in the paper jam will reprint.

Tips on preventing jams

You can avoid most paper jams by correctly loading paper and specialty media.

The following hints can help you avoid paper jams:

- Do not load wrinkled, creased, or damp paper.
- Never mix media types within a tray.
- Flex, fan, and straighten paper before you load it.
- Do not exceed the maximum stack height.
- Push all trays *firmly* into the printer after loading them.
- Make sure the guides in the trays are positioned snugly against the paper or specialty media.
- Do not remove paper trays while a job is printing. Wait for a Load Paper light sequence before you remove the tray.
- Before loading transparencies, fan the stack to prevent sheets from sticking together.
- Do not use envelopes that:
 - Have excessive curl
 - Are stuck together
 - Are damaged in any way
 - Contain windows, holes, perforations, cutouts, or embossing
 - Use metal clasps, string ties, or metal folding bars
 - Have postage stamps attached
 - Have any exposed adhesive when the flap is in the sealed position
- Use only recommended paper. Refer to the *Card Stock & Label Guide* available on the Lexmark Web site at www.lexmark.com for more information about which paper provides optimum results for current printing environment.

Tools

The removal and adjustment procedures require the following tools and equipment:

- Magnetic tip Phillips screwdrivers, large and small
- Volt ohmmeter

Types of print media

Ensure trays are properly loaded. Never mix media types within a tray.

Source	Sizes	Types	Weight	Capacity (sheets)
Tray 1 (250-sheet tray)	A4, A5, JIS B5, letter, legal, executive, folio, statement, Universal [‡]	Plain paper, transparencies, labels	60–90 g/m ² (16–24 lb)	<ul style="list-style-type: none"> • 250 paper • labels • 50 transparencies
Tray 2 (550-sheet tray)	A4, A5, JIS B5, letter, legal, executive, folio, statement, Universal [‡]	Plain paper, transparencies, labels	60–163 g/m ² (16–43 lb)	<ul style="list-style-type: none"> • 550 paper • labels • 50 transparencies • card stock
Manual feeder	A4, A5, JIS B5, letter, legal, executive, folio, statement, Universal [‡]	Plain paper, transparencies, labels, card stock [†]	60–163 g/m ² (16–43 lb)	1
	7¾, 9, 10, DL, C5, B5, other	Envelopes		
[†] Card stock up to 90# Index. Grain short is recommended. [‡] Universal size range: 76–216 x 127–356 mm (3.0–8.5 x 5.0–14.0 in.) (includes 3 x 5 in. cards).				

Abbreviations

ACM	Auto Comp Mechanism (or paper feed)
ASIC	Application Specific Integrated Circuit
CBM	Complete Bill Of Material
DIMM	Dual In-Line Memory Module
ENA	External Network Adapter
FRU	Field Replaceable Unit
HBP	Host Based Printing
HV	High Voltage
HVPS	High Voltage Power Supply
INTL	International
LVPS	Low Voltage Power Supply
NVRAM	Nonvolatile Random Access Memory
PCL	Printer Control Language
POR	Power-On Reset
POST	Power-On Self Test
PPDS	Personal Printer Data Stream
PRC	Peoples' Republic of China
PSO	Participating Standards Organization
RIP	Raster Image Processor
SDR	Synchronous Dynamic RAM
USB	Universal Serial Bus
V ac	Volts alternating current
V dc	Volts direct current

2. Diagnostic information

Start

POST (power-on self test)





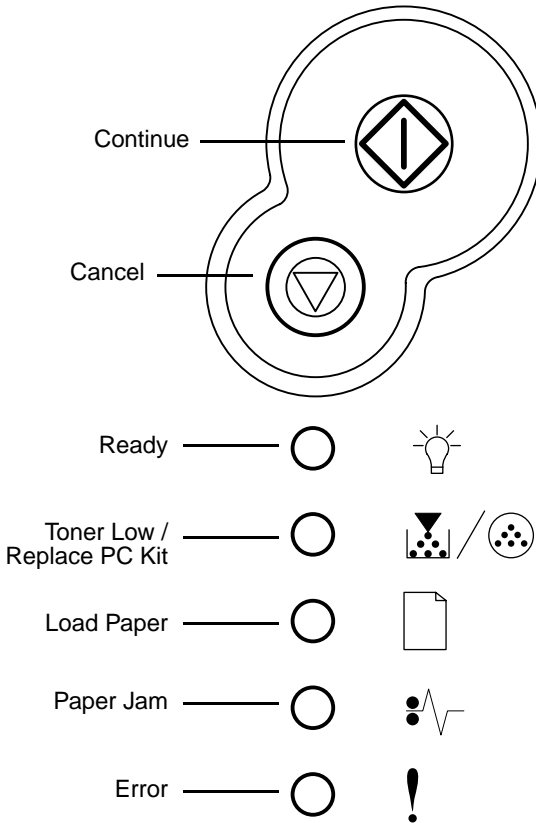

When you turn the printer on, it performs a POST. Check for correct POST functioning of the base printer by observing the following process:

1. All operator panel lights flash irregularly for approximately 10 seconds.
2. If there is a problem in the printer such as a paper jam, the panel lights indicate the problem. See **“Common light sequences” on page 2-3** for more information.
3. Otherwise, the  light flashes until the fuser comes up to temperature (5–20 additional seconds depending on the initial temperature of the fuser).

Note: The operator panel has six lights and two buttons. The  button has a light in it.

Overview of the operator panel



- Press and release  to resume printing.
- Press and release  twice quickly to display a secondary error code (following an error -  and  lights on).
- Press and release  to cancel the job currently printing.
- Press and hold  until all of the lights come on to reset the printer.

Understanding the operator panel lights

The operator panel lights mean different things, depending on their sequence. Lights that are off, on, and/or blinking indicate printer conditions such as printer status, intervention, or service.





The following tables show the most common light sequences.







Note: See **“Primary codes”** on page 2-8 for more information.





●	Light on
	Light is off
*	Light blinking
✕	Light blinking slow

Common light sequences

See **“Overview of the operator panel”** on page 2-2 for icon information.

					!	Printer condition
	●					Ready / Power Saver
	*					Busy
	✕					Hex Trace Ready
●	●					Waiting
	*				*	Flushing / Resolution reduced
●						Not ready (printer offline)
					●	Close door / Insert cartridge
●			●			Load media







						Printer condition
●			*			Load manual feeder
*			●			Print side two of duplex job
		●				Toner low
●		*				Replace photoconductor kit
●		*			*	Replace photoconductor kit (printer hard stop)
		*			●	Missing or defective toner cartridge
		●			●	Unsupported toner cartridge
		●			*	Change cartridge, invalid refill
	●				●	Invalid engine code / Invalid network code
	●	●	●			Programming engine code / Programming system code
●	●	●	●	●	●	Cancel job / Reset printer

					!	Printer condition
*	*	*	*	*	*	Service error (see “Service information with secondary and tertiary light patterns” on page 2-29 for more information).
*					●	Printer error (see “Secondary error codes” on page 2-19 for more information).

Secondary errors

When the ! and ◇ lights are both on, a secondary error has occurred. Press and release ◇ twice quickly to display the secondary error code light sequence. The following table shows what these light sequences mean.

◇	💡	📄/🔄	📄	📄	!	Printer condition
●					●	Printer error / Secondary error code
●	*			●		Paper jams in the manual feeder
●		●		●		Paper jams as it exits the tray into the printer
●			●	●		Paper jams as a printed job exits the printer
●	●				●	Complex page
●	*				●	Insufficient printer memory
●		●			●	Insufficient collation area
●		*			●	Font error
●			●		●	Defective flash
●			*		●	Insufficient defrag memory
●				●	●	Network interface errors
●				*	●	Error communicating with host computer
●	●	●			●	Memory full



						Printer condition
●	●		●		●	Short paper
●		●		●	●	Unformatted flash
●	●			●	●	Flash full
	●		●		●	Invalid engine code
	●		*		●	Invalid network code
Paper jam secondary codes						
●	●			●		200 Paper jam input sensor
●		●		●		201 Paper jam between input and exit sensors
●			●	●		202 Paper jam exit sensor
●		●	●	●		241 Paper jam Tray 1 jam
●	●		●	●		242 Paper Jam Tray 2 jam
●	*			●		251 Paper jam manual feeder

Operator panel codes









The following tables explain the primary light sequences, or codes, and secondary error codes, what they mean and how to clear them.

Primary codes



Ready / Power Saver

Light sequence	Meaning	Action:
	<ul style="list-style-type: none"> • Printer ready to receive and process data. • Printer is in Power Saver mode. 	<ul style="list-style-type: none"> • Send a print job. • Press  to print the menu settings pages for a list of current printer settings. • Press and hold  to reset the printer. <p>Note: To change the Power Saver setting, use the Local Printer Setup Utility. See <i>User's Reference</i> for more information.</p>





Busy

Light sequence	Meaning	Action:
	<ul style="list-style-type: none"> • Printer is busy receiving and processing data or printing. • Printer is defragmenting the flash memory to reclaim storage space occupied by deleted resources. • Printer is formatting the flash memory. • Printer is storing resources, such as fonts or macros, in flash memory. • Printer is printing a directory, font list, menu settings pages, or Print Quality Test Pages. 	<ul style="list-style-type: none"> • Busy: <ul style="list-style-type: none"> – Wait for message to clear. – Press and release  to cancel print job. – Press and hold  to reset printer. • Defragmenting flash, or formatting flash, or programming flash: <ul style="list-style-type: none"> – Wait for message to clear. – Warning: Do not turn the printer off while this message is displayed. • Printing a directory, a font list, menu settings pages, or Print Quality Test Pages: <ul style="list-style-type: none"> – Wait for the pages to print. The Busy message is displayed as the pages print. The  light is on when printing stops. – Press and release  to cancel printing. – Press and hold  to reset printer. • Receiving/processing data from a host interface: <ul style="list-style-type: none"> – Wait for message to clear. – Press and release  to stop processing. – Press and hold  to reset printer.





Hex Trace Ready

Light sequence	Meaning	Action:
	<p>Printer is in the Ready mode and Hex Trace is active.</p>	<ul style="list-style-type: none"> Hex Trace helps troubleshoot printing problems. After resolving the problem, turn off the printer to exit Hex Trace. Or, press and hold  to reset the printer.





Waiting

Light sequence	Meaning	Action:
	<p>Printer is waiting until a print timeout occurs, or until it receives additional data.</p>	<ul style="list-style-type: none"> Press and release  to print contents of the print buffer. Press and release  to cancel the print job. Press and hold  to reset the printer.

Flushing / Resolution reduced

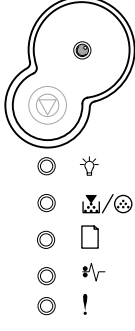
Light sequence	Meaning	Action:
	<ul style="list-style-type: none"> • Printer is flushing corrupted print data. • Printer is processing data or printing pages, but the resolution of a page in the current print job is reduced from 600 dots per inch (dpi) to 300 dpi to prevent a memory full error. 	<ul style="list-style-type: none"> • Wait until  is displayed to print other jobs. • Press and release  to cancel print job. • Press and hold  to reset printer.



Not ready

Light sequence	Meaning	Action:
	<p>Printer is not ready to receive or process data, or the printer ports are offline.</p>	<ul style="list-style-type: none"> • Press  to return to  or Busy state. • Press and release  to cancel print job. • Press and hold  to reset printer.



Close door / Insert cartridge

Light sequence	Meaning	Action:
	<p>The printer door is open.</p>	<p>Close the door.</p>



Load media

Light sequence	Meaning	Action:
	<p>The printer is out of media, or the media did not feed properly.</p>	<ul style="list-style-type: none"> • Load media into tray 1 or the optional 550-sheet tray and press  to resume printing. • Check that the media is loaded correctly in tray 1 or the optional 550-sheet tray. • Press  to cancel the print job.





Load manual feeder

Light sequence	Meaning	Action:
	<p>Printer prompts to load a single sheet of media in the manual feeder.</p>	<ul style="list-style-type: none"> • Load media, with the side to be printed facing the front of the printer, into the manual feeder. • Press  to resume printing. • Press and hold  to reset printer.



Print side two of duplex job

Light sequence	Meaning	Action:
	<p>Print the other side of duplex print job.</p>	<ul style="list-style-type: none"> • Reinsert print job in tray 1 using the instructions in the driver pop-up menu to orient the pages correctly. • Press  to resume printing. • Press and hold  to reset printer.

Toner low

Light sequence	Meaning	Action:
	<ul style="list-style-type: none"> • Printer is ready to receive and process data. • The toner in the toner cartridge is getting low. 	<ul style="list-style-type: none"> • Send a print job. • Press  to print the menu settings page for a list of current settings. • Remove the toner cartridge and shake it to extend the life of the cartridge. • Replace the toner cartridge. • Press and hold  to reset printer. <p>Note: The  light may not come on if the starter toner cartridge is installed in a base printer model.</p>

Replace photoconductor kit

Light sequence	Meaning	Action:
	<p>The photoconductor kit's drum is full and needs replacing.</p>	<ul style="list-style-type: none"> • Press  to resume printing. • Replace the photoconductor kit.

Replace photoconductor kit (printer hard stop)

Light sequence	Meaning	Action:
	<p>The photoconductor kit's drum is full and needs replacing. No pages print until the photoconductor kit is replaced.</p>	<ul style="list-style-type: none"> • Replace the photoconductor kit.

Toner cartridge error / Toner cartridge is not installed

Light sequence	Meaning	Action:
	<p>The toner cartridge is not installed, or the printer detects a toner cartridge error.</p>	<ul style="list-style-type: none"> • If the toner cartridge is not installed, install it. • If the toner cartridge is installed, remove it and install a new toner cartridge.

Change invalid toner cartridge

Light sequence	Meaning	Action:
	<p>The toner cartridge being used is not designed for this printer.</p>	<p>Install a toner cartridge compatible to printer.</p>

Invalid engine code / Invalid network code

Light sequence	Meaning	Action:
	<p>The code in an internal print server has not been programmed, or the programmed code is not valid.</p>	<ul style="list-style-type: none"> • Download valid network code to the internal print server. • Press \diamond twice quickly to see the secondary error code.

Programming engine code / Programming system code

Light sequence	Meaning	Action:
	<p>New code is being programmed into the engine or firmware code flash.</p>	<p>Wait for the message to clear. When the printer has finished programming the code, it performs a soft reset.</p>



Cancel job / Reset printer

Light sequence	Meaning	Action:
	<ul style="list-style-type: none"> • The current print job is canceled. • The printer is resetting to the user default settings. <ul style="list-style-type: none"> – Any active print jobs are canceled. – A user default setting remains in effect until changed or until restored to factory default settings. 	<p>Wait for the message to clear.</p>

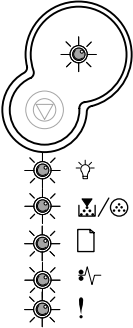
Service error

Light sequence	Meaning	Action:
	<p>The printer has a service error and printing has stopped.</p>	<p>Turn the printer off and back on.</p> <p>If the lights are still blinking, contact the place where printer was purchased.</p>

Printer error

Light sequence	Meaning	Action:
	<p>The printer has one of the following errors:</p> <ul style="list-style-type: none"> • Memory is full, insufficient to save what is in the buffer, or insufficient to defragment flash memory. • A page is too complex to print or is shorter than the set page margins. • Resolution of a formatted page is reduced to 300 dpi. • A font error occurred. • Communication with the host computer is lost. 	<ul style="list-style-type: none"> • Press  twice quickly to see the secondary error code. See “Secondary error codes” on page 2-19 for more information. • Press  to clear the secondary message.

Secondary error codes

- When the ! and ◇ lights are both on, a secondary error has occurred. Press and release ◇ twice quickly to display the secondary error code light sequence.
- When the ⚡ and ◇ lights are both on, a paper jam secondary error has occurred.

Press and release ◇ twice to display the secondary error code light sequence.

The following tables show what these light sequences mean and what to do.

Paper jam in the manual feeder

Light sequence	Meaning	Action:
	<p>A paper jam has occurred in the manual feeder.</p>	<p>Clear the paper jam.</p>

Paper jams as it exits the tray into the printer

Light sequence	Meaning	Action:
	<p>A paper jam has occurred as the paper is exiting the paper tray and entering the printer.</p>	<p>Clear the paper jam.</p>



Paper jams as a printed job exits the printer

Light sequence	Meaning	Action:
 <p>The diagram shows a printer's control panel with a large 'X' over the top section. Below it, a vertical column of seven indicator lights is shown. From top to bottom, the lights are: a solid circle, a circle with a lightbulb, a circle with a paper roll and a crossed-out circle, a circle with a document icon, a circle with a lightning bolt and a checkmark, and a solid circle with an exclamation mark.</p>	<p>A paper jam has occurred as the paper is exiting the printer.</p>	<p>Clear the paper jam.</p>





Complex page

Light sequence	Meaning	Action:
 <p>The diagram shows a printer's control panel with a large 'X' over the top section. Below it, a vertical column of seven indicator lights is shown. From top to bottom, the lights are: a solid circle with a lightbulb, a circle with a paper roll and a crossed-out circle, a circle with a document icon, a circle with a lightning bolt and a checkmark, and a solid circle with an exclamation mark.</p>	<p>The page may not print correctly because the print information on the page is too complex (that is, too large for the printer's memory).</p>	<ul style="list-style-type: none"> • Press \diamond to clear the message and continue processing the print job (some of the print data may be lost). • To avoid this error in the future: <ul style="list-style-type: none"> – Reduce the complexity of the page by reducing the amount of text or graphics on the page and deleting unnecessary downloaded fonts or macros. – Set Page Protect to on in the Local Printer Setup Utility. • Install additional printer memory.





Insufficient printer memory

Light sequence	Meaning	Action:
	<p>The printer does not have enough memory to save the data in the buffer.</p>	<ul style="list-style-type: none"> • Install additional memory. • Press  to continue printing the job. • Press  to cancel the print job.



Insufficient collation area

Light sequence	Meaning	Action:
	<p>The printer memory does not have the free space necessary to collate the print job. This may happen due to one of these errors:</p> <ul style="list-style-type: none"> • Memory is full. • A page is too complex to print. • A page is shorter than the set page margins. • Memory is insufficient to save what is in the buffer. 	<ul style="list-style-type: none"> • Press  to clear the message and continue printing the job (the job may not print correctly.) • Press and release  to cancel the print job. • Press and hold  to reset the printer. • To avoid this error in the future: <ul style="list-style-type: none"> – Simplify the print job. Reduce the complexity of the page by reducing the amount of text or graphics on the page and deleting unnecessary downloaded fonts or macros. • Install additional printer memory.

Font error

Light sequence	Meaning	Action:
 <p>The diagram shows a printer's light panel layout. At the top is a large, irregularly shaped light panel with a small circle in the upper right and a larger circle with a downward-pointing triangle in the lower left. Below this are two columns of smaller icons: a light bulb, a printer with a document, a document with a checkmark, a document with a lightning bolt, a document with a checkmark and a lightning bolt, a document with a lightning bolt, and a document with a lightning bolt and an exclamation point.</p>	<p>The printer has received a request for a PPDS font which is not installed.</p>	<ul style="list-style-type: none"> • Press and release  to cancel the print job. • Press and hold  to reset the printer. • Press and release  to clear the message and continue printing.



Defective flash

Light sequence	Meaning	Action:
 <p>The diagram shows a printer's light panel layout. At the top is a large, irregularly shaped light panel with a small circle in the upper right and a larger circle with a downward-pointing triangle in the lower left. Below this are two columns of smaller icons: a light bulb, a printer with a document, a document with a lightning bolt, a document with a lightning bolt and an exclamation point, a document with a lightning bolt, and a document with a lightning bolt and an exclamation point.</p>	<p>The printer detects defective flash memory.</p>	<ul style="list-style-type: none"> • Press  to clear the message and continue printing. <ul style="list-style-type: none"> – Downloaded fonts and macros not previously stored in flash memory are deleted. • Install flash memory.



Insufficient defrag memory

Light sequence	Meaning	Action:
	<p>The printer has insufficient memory to free unused space in flash memory.</p>	<ul style="list-style-type: none"> • Delete fonts, macros, and other data in RAM. • Install additional printer memory.





Network interface errors

Light sequence	Meaning	Action:
	<p>The printer cannot establish communication with the network.</p>	<p>Press  to clear the message and continue printing (the job may not print correctly).</p>



Error communicating with host computer

Light sequence	Meaning	Action:
 <p>The diagram shows a printer with a cloud-like shape. A central light is illuminated. Below the printer, there are several rows of icons: a power button, a network icon, a paper tray icon, a paper tray with a checkmark, a paper tray with an error, a paper tray with a checkmark, a paper tray with an error, a paper tray with a checkmark, and a paper tray with an error.</p>	<p>The printer has lost the connection to an external print server (also called an external network adapter or external network adapter (ENA)).</p> <p>This light sequence is displayed if your printer is connected to the network, but it cannot detect the print server when you turn on the printer.</p>	<ul style="list-style-type: none"> • Make sure the cable connecting the ENA and the printer is securely attached. • Turn the printer off and then on to reset the printer. • Press and hold  to reset the printer.





Memory full

Light sequence	Meaning	Action:
 <p>The diagram shows a printer with a cloud-like shape. A central light is illuminated. Below the printer, there are several rows of icons: a power button, a network icon, a paper tray icon, a paper tray with a checkmark, a paper tray with an error, a paper tray with a checkmark, a paper tray with an error, a paper tray with a checkmark, and a paper tray with an error.</p>	<p>The printer is processing data, but the memory used to store pages is full.</p>	<ul style="list-style-type: none"> • Press  to clear the message and continue printing the job (the job may not print correctly). • Press and release  to cancel the print job. • Press and hold  to reset the printer. • To avoid this error in the future: <ul style="list-style-type: none"> – Simplify the print job. Reduce the complexity of the page by reducing the amount of text or graphics on the page and deleting unnecessary downloaded fonts or macros. • Install additional printer memory.

Short paper

Light sequence	Meaning	Action:
	<p>The paper length is too short to print the formatted data. This occurs when the printer does not know the media size loaded in the tray, or there is a problem feeding the media.</p>	<ul style="list-style-type: none"> • Make sure the print media you loaded is large enough. • Open the front cover, clear the paper path and close the cover to resume printing. • Press  to clear the message and continue printing the job. • Press  to cancel the print job.

Flash full

Light sequence	Meaning	Action:
	<p>There is not enough free space in the flash memory to store the data you are trying to download.</p>	<ul style="list-style-type: none"> • Delete fonts, macros, and other data stored on the flash memory to free up space. • Press  to clear the message and continue printing. <ul style="list-style-type: none"> –Downloaded fonts and macros not previously stored in flash memory are deleted. • Install flash memory with more storage capacity. • Press and release  to cancel the print job. • Press and hold  to reset the printer.

Unformatted flash

Light sequence	Meaning	Action:
	<p>The printer detects unformatted flash memory.</p>	<ul style="list-style-type: none"> • Press \diamond to clear the message and continue printing. The job may not print correctly. • Reformat the flash memory. Refer to the <i>Technical Reference</i> on Lexmark's Web site for more information. • If the error message remains, the flash memory may be defective and should be replaced.

Invalid engine code

Light sequence	Meaning	Action:
	<p>The code in an internal print server has not been programmed, or the programmed code is not valid.</p>	<p>Download valid engine code to the internal print server.</p>

Invalid network code

Light sequence	Meaning	Action:
	<p>The code in an internal print server has not been programmed, or the programmed code is not valid.</p>	<p>Download valid network code to the internal print server.</p>

Service information with secondary and tertiary light patterns



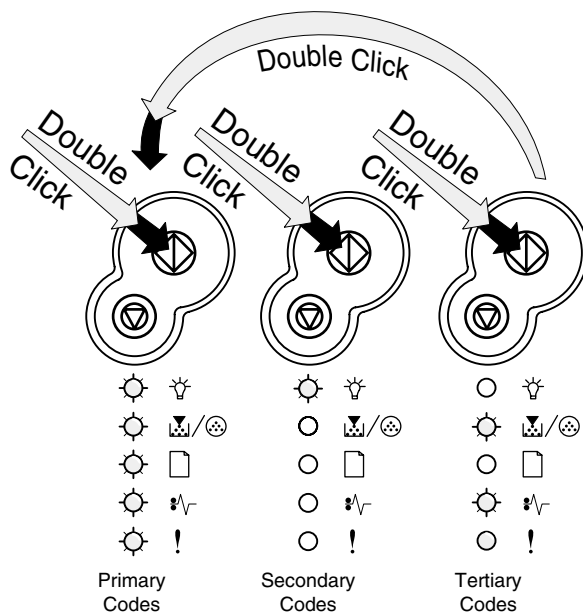



All service errors are indicated by all lights flashing as the primary notification or code. The secondary code indicates an area or function which has the error. Tertiary codes (shown on the following pages) indicate specific device errors. Double click \diamond to see the secondary code. Double click \diamond again to see the tertiary code.



Note: All lights flashing simultaneously, as a result of sending data to the printer, may indicate a code problem. Call the next level of support.

●	Light on
	Light off
*	Light blinking
✕	Light blinking slow

Secondary error codes

		Secondary codes									
Lights	Primary code	901	91x	92x	93x	94x	95x	96x	97x	98x	99x
 Continue	*	*	*	*	*	*	*	*	*	*	*
 Ready	*										
 Toner Low / Replace PC Kit	*									*	*
 Load Paper	*					*	*	*	*		
 Paper Jam	*			*	*			*	*		
 Error	*		*		*		*		*		*

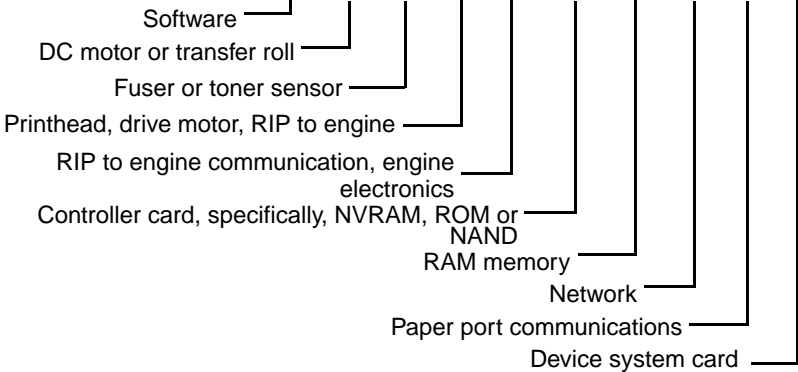

Tertiary service error codes

Service error codes are generally non-recoverable except in an intermittent condition when you can POR (power-on reset) the printer to temporarily recover from the error.







Note: All service errors are initially communicated by all lights flashing which is the primary indication or code. For brevity, this indication is not repeated in the following codes.

1. Controller software error/illegal trap (90x)

Call the next level of support for a 900 error.

For the other errors, which indicate a faulty programming process or faulty component on the controller card, replace the controller card.

Controller software

		Tertiary codes						
Lights		900	901	902	903	904	905	906
 Continue	*							
 Ready	●	*	*	*	*	*	*	*
 Toner Low / Replace PC Kit	●							
 Load Paper	●					*	*	*
 Paper Jam	●			*	*			*
 Error	●		*		*		*	

Secondary code

RIP
interface
driver
error

General engine
software error

Faulty engine code flash or
programming failed







Contact next level of support or
1-800-539-6275

Transfer roll



CAUTION: When you see this symbol, there is a danger from hazardous voltage in the area of the product where you are working. Unplug the product before you begin, or use caution if the product must receive power in order to perform the task.







Code 917 indicates a problem in the transfer roll circuit. Check the continuity from the cable connection on the HVPS (high voltage power supply) to the right side of the transfer roll.

		Tertiary code						
Lights								917
 Continue	*							
 Ready	●							*
 Toner Low / Replace PC Kit	●							
 Load Paper	●							*
 Paper Jam	●							*
 Error	*							*

Secondary code

Fuser, fan, or toner sensor error

Codes 920 through 929 indicate a problem in the fuser (see **“Fuser service check” on page 2-53** for more information), a stalled fan motor or a faulty toner sensor or toner cartridge.

		Tertiary codes									
Lights		920	921	922	923	924	925	926	927	928	929
 Continue	*										
 Ready	●	*	*	*	*	*	*	*	*	*	*
 Toner Low / Replace PC Kit	●									*	*
 Load Paper	●					*	*	*	*		
 Paper Jam	*			*	*			*	*		
 Error	●		*		*		*		*		*

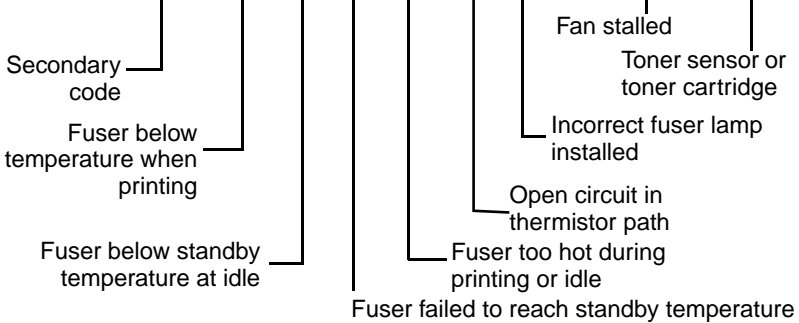







Printhead, transport motor or RIP/engine communication error

Codes 930 through 935 indicate a problem with the printhead.
Check cables to the printhead. Replace the printhead as necessary.

Codes 936 and 937 indicate a problem in the drive system.

4505





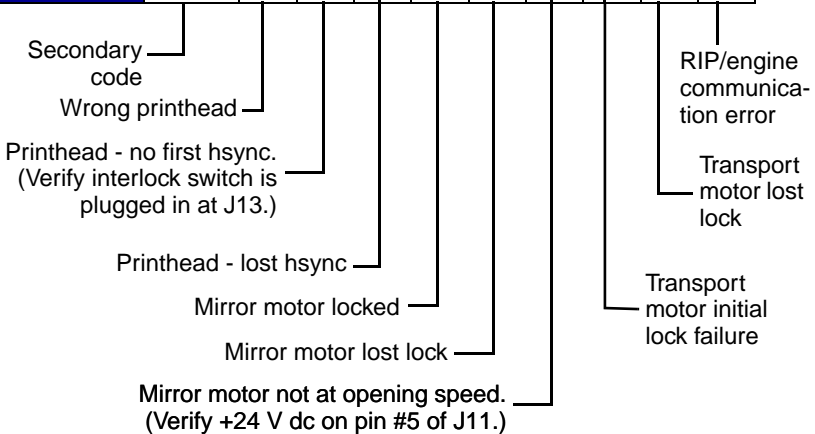

Code 939 indicates a communication failure between the RIP and engine processors.

Code		Tertiary codes								
		930	931	932	933	934	935	936	937	939
 Continue	*									
 Ready	●	*	*	*	*	*	*	*	*	*
 Toner Low / Replace PC Kit	●									*
 Load Paper	●					*	*	*	*	
 Paper Jam	*			*	*			*	*	
 Error	*		*		*		*		*	*



RIP to engine communication failure (controller card).

This indicates fuser control in the LVPS has failed or the wrong LVPS has been installed.







		Tertiary codes
Code		940
 Continue	*	
 Ready	●	*
 Toner Low / Replace PC Kit	●	
 Load Paper	*	
 Paper Jam	●	
 Error	●	

Secondary code

4505

NVRAM failure

Error codes 950–954 indicate a problem in the NVRAM (nonvolatile random access memory). Replace the operator panel assembly. Codes 955–959 indicate a failed controller card assembly. Replace the controller card.

Code		Tertiary codes								
		950	951	952	954	955	956	957	958	959
 Continue	*									
 Ready	●	*	*	*	*	*	*	*	*	*
 Toner Low / Replace PC Kit	●								*	*
 Load Paper	*				*	*	*	*		
 Paper Jam	●			*			*	*		
 Error	*		*			*		*		*

Secondary code

NVRAM data does not
match secure NVRAM

RIP firmware cannot
communicate with secure
NVRAM

NVRAM chip failure

NVRAM CRC failure

SRAM
failure

NAND
failure

ASIC failure







Processor failure

Code ROM or NAND
failed cyclic redundancy
check (CRC)

Note: NVRAM is on the operator panel printed circuit board (PCB) while secure NVRAM is on the controller PCB. Check margin alignments after replacing the operator panel assembly. See **“Printhead service check” on page 2-61** for more information. If margin errors are unacceptable, corrections can only be made through software. Contact the next level of support or Lexmark at 1-800-539-6275.

RAM memory error

This error indicates RAM failure. Remove DIMM(s) and POR the printer. If the error persists, replace the card. If the error subsides, check each DIMM independently. Replace faulty DIMM.

		Tertiary codes			
Code		960	961	962	963
 Continue	*				
 Ready	●	*	*	*	*
 Toner Low / Replace PC Kit	●				
 Load Paper	*				
 Paper Jam	*			*	*
 Error	●		*		*







Secondary
code

RAM in slot 1 is bad

RAM soldered on the board is bad

Network error





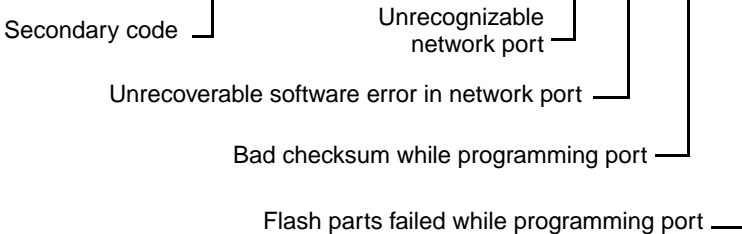

Indicates an error in the network circuitry. Replace the controller card assembly.

		Tertiary codes								
Code		970	971	972	973	974	975	976	978	979
 Continue	*									
 Ready	●	*	*	*	*	*	*	*	*	*
 Toner Low / Replace PC Kit	●								*	*
 Load Paper	*					*	*	*		
 Paper Jam	*			*	*			*		
 Error	*		*		*		*			*



Paper port communication failure

Indicates an error communicating with Tray 2, if installed. Remove Tray 2 and recheck. If the error does not recur, replace Tray 2. If the error recurs, replace the controller card assembly

		Tertiary codes				
Code		980	981	982	983	984
 Continue	*					
 Ready	●	*	*	*	*	*
 Toner Low / Replace PC Kit	*					
 Load Paper	●					*
 Paper Jam	●			*	*	
 Error	●		*		*	

Secondary code

Engine experiencing
unreliable communications
to specified device

Engine protocol violation detected by
the specified device

Invalid command
parameter
received by
specified device

Invalid command
received by specified
device

Communications error detected by
specified device

Symptom tables

POST symptom table

Symptom	Action
The main motor, cooling fan, and fuser do not come on.	See “Cover interlock switch service check” on page 2-51.
POST completes except one or more lights do not come on.	See “Operator panel service check” on page 2-59.
None of the lights come on.	See “Operator panel service check” on page 2-59.
Main motor does not come on.	See “Main motor service check” on page 2-58.
Fan does not come on.	See “Cooling fan service check” on page 2-48.
Fuser lamp does not come on.	See “Cold fuser service check” on page 2-47.
Fuser lamp never turns off.	See “Hot fuser service check” on page 2-56.
The paper feed picks and tries to feed paper.	See “Paper feed service checks” on page 2-61.

Printer symptom table

Symptom	Action
Dead machine (no power)	See “Dead machine service check” on page 2-52.
Fan noisy or not working	See “Cooling fan service check” on page 2-48.
Fuser parts melted	See “Hot fuser service check” on page 2-56.
Fuser lamp doesn't light	See “Cold fuser service check” on page 2-47.
Toner not fused to the paper	See “Cold fuser service check” on page 2-47.
Paper jams	See “Paper feed service checks” on page 2-61.
Main motor noisy or not moving	See “Main motor service check” on page 2-58.
Paper skew	See “Paper feed service checks” on page 2-61.
Printer not communicating with host	See “Parallel port service check” on page 2-65.
Front access cover will not close	See “Cover interlock switch service check” on page 2-51.
Operator panel button not responding	See “Operator panel service check” on page 2-59 or “Controller card service check” on page 2-49.
Operator panel lights are off or very dim	See “Controller card service check” on page 2-49.
Blank page	See “Blank page” on page 2-67.
Black page	See “Black page” on page 2-68.
Heavy background	See “Heavy background” on page 2-69.
Light print	See “Light print” on page 2-71.

Symptom	Action
White or black lines or bands	See “White or black lines or bands” on page 2-72.
Toner on back of page	See “Toner on back of page” on page 2-72.
Paper never picks	See “Paper never picks” on page 2-63.
Paper feeds continuously	See “Paper picks during POST and/or continuously” on page 2-62.
Paper wrinkled or bent	See “Paper “trees,” wrinkles, stacks poorly or curls” on page 2-65.

Service checks



Service checks which involve measuring voltages on the LVPS/HVPS (low voltage power supply/high voltage power supply board) should be performed with the printer positioned on its back side.

Note: When you make voltage readings, always use frame ground unless another ground is specified. See **“Wiring diagram” on page 5-4** for more information.

Cold fuser service check

Make sure the correct voltage lamp is installed. The voltage rating is stamped on one of the lamp contacts.

FRU	Action
 <p>Fuser AC cables LVPS/HVPS Fuser</p>	<p>If the fuser lamp comes on and a fuser failure light error code displays, be sure the thermistor is contacting the hot roll and the thermistor cable is firmly seated in connector J15 on the controller card.</p> <p>Check for excessive toner buildup on the surface of the thermistor. Clean as necessary.</p> <p>With the printer unplugged, disconnect the thermistor cable from J15 on the controller card.</p> <p>Measure the resistance of the thermistor. The resistance measures from approximately 1K ohms immediately after printing or POR to approximately 240K ohms when thermistor reaches room temperature. (It may take 30 minutes to cool.)</p> <p>Replace the fuser assembly as necessary.</p>

Cooling fan service check

FRU	Action
Cooling fan	<p>Make sure the fan cable plug is properly seated at J19 (controller card).</p> <p>Turn the printer off and disconnect the cooling fan cable from the controller card.</p> <p>Turn the printer on. Within a few seconds the controller card assembly should apply between +24 V dc to pin 2. See “Controller board” on page 5-3 for more information.</p> <ul style="list-style-type: none"> • If voltage is present and the fan is not turning, replace the cooling fan. If the fan still doesn't function, replace the controller card. <p>Note: The fan speed is controlled by a module on the PCB. Between +8 V and +24 V dc are constantly supplied at pin 2 (J19). Pin 1 is ground while pin 3 receives feedback from the fan motor.</p> <ul style="list-style-type: none"> • If voltage is not present, see “Controller board” on page 5-3 for more information.

Controller card service check

FRU	Action
Controller card assembly	<p>Verify +24 V dc input from the LVPS/HVPS.</p> <ul style="list-style-type: none"> • Turn the printer off. • Disconnect the LVPS/HVPS cable from the controller card at J7. See “Controller board” on page 5-3 for more information. • Turn the printer on. <p>Verify +24 V dc from the cable connector of J9, pin 8.</p> <p>Verify that pin 7 on both the cable and the card connectors is ground.</p> <ul style="list-style-type: none"> • If voltage is correct, check the continuity in the cable. If the cable is good, see the “Controller board” on page 5-3 for more information. • If grounds are not correct on the cable, first check it for continuity and then the LVPS/HVPS. • If the grounds are not correct on the controller card, replace the controller card. (Check with one probe on the connector pin and the other on the card's ground plane found at each screw head.)

Controller card service check (continued)

FRU	Action
Controller card assembly	<p>Note: With all cables connected, the printer should complete POST within approximately 12–15 seconds in the following sequence:</p> <ol style="list-style-type: none"> 1. All operator panel lights on solid momentarily. 2. Lights then flash on and off sequentially. <p>After lights quit flashing, the  light turns on solid.</p> <ol style="list-style-type: none"> 3. The cooling fan comes on. 4. The fuser lamp comes on. 5. The drive motor runs. 6. The printhead motor runs. 7. The printer cycles down into standby mode/ready. <p>If immediately following power-on the operator panel lights are active but the printer does not go through steps 1 and 2 above, replace the controller card assembly.</p> <p>Note: Settings for U.S. versus non-U.S. and the printer configuration ID can be changed. See “Configuration and diagnostic groups” on page 3-1 for more information.</p> <p>If some lights are on or flashing, see “Common light sequences” on page 2-3 to determine action required.</p>

Cover interlock switch service check

Note: Make sure a print cartridge assembly is installed and the cover closes all the way, engaging the cover open switch lever.

FRU	Action
Cover interlock switch	<p>Disconnect the cover interlock cable from the controller card at J13.</p> <p>Verify continuity between cable pin 1 and pin 2 with the door closed but not open.</p> <p>Verify continuity between cable pin 1 and pin 3 with the door open but not closed.</p> <ul style="list-style-type: none"> • If either fail continuity, replace the cover interlock switch. • If both pass continuity, turn the printer on and verify +5 V dc on pin 2 at J6 on the controller card. • Verify pins 1 and 3 are ground. • If voltage or ground is not present, see “Controller card service check” on page 2-49 for more information. <p>Verify discontinuity between pins 2 and 3 whether the door is open or closed.</p> <p>Replace the cover interlock switch if faulty.</p>

Dead machine service check



CAUTION: Check the AC line voltage. The voltage should be within the following limits:

- 100 V ac (volts alternating current) – 127 V ac for the 110 V printer
- 200 V ac – 240 V ac for the 220 V printer

FRU	Action
 LVPS/HVPS	<p>Unplug the printer and check the fuses on the LVPS/HVPS board for continuity.</p> <ul style="list-style-type: none"> • If open, replace the LVPS/HVPS board. <ul style="list-style-type: none"> – If fuse opens again, see “LVPS/HVPS service check” on page 2-57 for more information • If not open, unplug the cables at CN102 and CN201 (fuser and controller card respectively). Plug LVPS/HVPS board to source and turn switch on. <p>Verify 24 V dc on pin 8 at connector CN201.</p> <p>Verify line voltage (110 or 220 V ac) across pins 1 and 2 of CN102.</p> <ul style="list-style-type: none"> • If either voltage is not correct, replace the LVPS/HVPS board. • If both voltages are correct, check the controller card. See “Controller board” on page 5-3 for more information. <p>Verify grounds.</p>

Fuser service check

When toner is partially fused to the paper, it is usually caused by low fuser temperature.

Warning: Avoid handling the lamp as much as possible as it is easily broken. Be careful not to touch the glass housing with bare hands because skin acids can weaken the glass. The lamp is not a service part.

The line voltage to the printer must be within the following limits:

- 100 V ac–127 V ac for the 110 V model printer
- 200 V ac–240 V ac for the 220 V model printer

Turn the printer off and wait a few minutes for the fuser lamp to cool. Turn the printer on and observe the lamp turning on during POST.



You can see the light from the lamp by opening the left side cover and observing the upper opening through which the fuser power cables pass.

Fuser service check (continued)

FRU	Action
 <p>Lamp cable LVPS/HVPS Fuser</p>	<p>Unplug the printer and disconnect the fuser lamp cable plug from the LVPS/HVPS board connector CN102.</p> <p>Check for continuity across the fuser lamp by checking across the connector pins.</p> <ul style="list-style-type: none"> • If there is continuity, go to Step 1: Continuity. • If there is no continuity, go to Step 2: No continuity. <p>Step 1: Continuity Turn the printer on with only the fuser power disconnected.</p> <p>Measure the voltage at connector CN2 on the LVPS/HVPS. It should match the line voltage.</p> <ul style="list-style-type: none"> • If line voltage is not present, see “LVPS/HVPS service check” on page 2-57 for more information. <p>Make sure the fuser thermistor is correctly connected to the controller board. If the problem persists, disconnect the thermistor cable at J15 and check for less than +5 V dc on pin 1. Pin 2 should be ground.</p> <ul style="list-style-type: none"> • If line voltage is incorrect on pin 1, see “Controller card service check” on page 2-49 for more information. <p>Step 2: No continuity Check the lamp cable for continuity.</p> <ul style="list-style-type: none"> • If correct, replace the fuser. • If incorrect, replace the lamp cable.

Fuser service check (continued)

FRU	Action
 <p data-bbox="139 410 330 435">Fuser (continued)</p>	<p data-bbox="546 269 937 321">Disconnect the thermistor cable from J15 on the controller card.</p> <p data-bbox="546 337 919 440">Measure the resistance across the ends of the thermistor cable. See “Connector locations” on page 5-1 for more information.</p> <p data-bbox="546 456 919 532">Replace the fuser assembly if the resistance is lower than 1K ohm or shorted.</p> <p data-bbox="546 548 905 651">Note: Resistance measures approximately 240K ohms when cool and 1.4K ohms hot.</p>

Hot fuser service check

Note: Ensure correct lamp is installed.

FRU	Action
 <p>Fuser AC cables LVPS/HVPS Fuser</p>	<p>Measure the resistance of the thermistor. The resistance measures from approximately 1K ohms immediately after printing or POR to approximately 240K ohms when thermistor reaches room temperature. (It may take 30 minutes to cool.)</p> <p>Replace the fuser assembly as necessary.</p>

LVPS/HVPS service check

FRU	Action
 <p>LVPS/HVPS</p>	<p>LVPS portion of board Fuses that open typically indicate a faulty LVPS/HVPS.</p> <p>Use the voltage meter to verify the appropriate voltage at the printer end of the power cable.</p> <p>Remove the LVPS/HVPS assembly from the printer.</p> <p>Check continuity on the fuses.</p> <p>If either fuse has opened, replace the card.</p> <p>Ensure the switch is off and plug the power cord into the card.</p> <p>Turn the switch on.</p> <p>CAUTION: The card has several points where AC voltage is exposed.</p> <p>Carefully verify the AC voltage between pins 1 and 2 matches the power cable (wall) voltage.</p> <ul style="list-style-type: none"> • If voltage is incorrect, replace the card assembly. <p>Verify +24 V dc from pin 8 at CN201.</p> <ul style="list-style-type: none"> • If voltage is incorrect, replace the card assembly. <p>HVPS portion of board Problems with the HVPS are exhibited in the print quality. See “Print quality service checks” on page 2-66 for more information.</p>

Main motor service check



FRU	Action
<div data-bbox="114 315 210 399" data-label="Image"> </div> <p data-bbox="114 418 303 495">Main motor cable LVPS/HVPS Controller card</p> <p data-bbox="154 524 476 868">Warning: <i>Do not</i> replace the operator panel and controller card at the same time. Each card contains the printer settings. When either of these cards is new, it obtains the settings from the other card. Settings are lost when both are new and replaced at the same time.</p>	<p data-bbox="522 277 875 329">Verify +24 V dc at J9, pin 8 and +5 V dc at pin 1 (controller card).</p> <p data-bbox="522 342 910 394">Verify ground at pins 2 and 7 for both the card and cable.</p> <ul data-bbox="529 407 910 789" style="list-style-type: none"> • If these voltages are correct, check the main motor cable for continuity. <ul data-bbox="551 496 910 678" style="list-style-type: none"> – Remove rear cover to access connector on motor. – If continuity exists on each wire, call next level of service. – If continuity does not exist on one or more of the wires, replace the motor cable. • If these voltages are not correct, see the “LVPS/HVPS service check” on page 2-57 or replace the controller card. <p data-bbox="522 797 846 849">Note: The main motor is not a service part.</p>

Operator panel service check

Inspect the operator panel cable for damage. Make sure the cable is plugged in securely.

Run POST and check each light for proper operation.

Operator panel service check

FRU	Action
Operator panel	<p>Buttons</p> <p>Open controller card cage and locate the operator panel connector at J16.</p> <p>Check for continuity between pins 1 and 2 of the cable as you press the Continue  button.</p> <p>Similarly, check the continuity between pins 1 and 6 of the cable while pressing Cancel  .</p> <ul style="list-style-type: none"> • If continuity is not present, replace the operator panel. <p>Note: Check margin alignments after replacing the operator panel assembly. If margin errors are unacceptable, corrections can only be made through software. Contact the next level of support or Lexmark at 1-800-539-6275.</p>

Operator panel service check (continued)

FRU	Action
<p>Operator panel Controller card</p> <p>Warning: <i>Do not</i> replace the operator panel and controller card at the same time. Each card contains the printer settings. When either of these cards is new, it obtains the settings from the other card. Settings are lost when both are new and replaced at the same time.</p>	<p>Lights</p> <p>If none of the lights come on, make sure the cable is properly connected to the controller card and the controller card has input voltage to it.</p> <p>Verify +24 V dc on cable pin 8 at J7.</p> <ul style="list-style-type: none"> • Check for +5 V dc at J16, pin 5 See “Controller card service check” on page 2-49 or page 5-3 for more information. • If these voltages are not correct, replace the controller card. • If these voltages are correct, replace the operator panel. <p>If more than one light does not turn on or an individual light stays on solid during POST, replace the operator panel.</p> <p>If all lights are dim and operate erratically during POST or all lights come on and stay on solid during POST, replace the FRUs in the following order one at a time:</p> <ul style="list-style-type: none"> • Controller card • Operator panel

Printhead service check

FRU	Action
 <p>Printhead</p>	<p>Unplug the printer.</p> <p>Disconnect the printhead cables from J11 and J12 on the controller card.</p> <p>Turn the printer on.</p> <p>On the controller card, verify +24 V dc on pin 5 at J11 and +5 V dc on pin 7 at J12.</p> <p>Verify grounds on pin 4 at J11 and on pins 2, 6, and 8 at J12.</p> <ul style="list-style-type: none"> • If voltages or grounds are incorrect, check the controller card. See “Controller card service check” on page 2-49 for more information. • If voltages are correct, replace the printhead (comes with cables).

Paper feed service checks

Paper jam error indication during POST

FRU	Action
Exit sensor	<p>If the exit sensor flag is not resting within the paper exit sensor during POST, the printer displays a paper jam message. Make sure the flag is operating freely and is correctly installed.</p>
Input sensor Input sensor #1 (under print cartridge assembly) and Input sensor #2 (manual)	<p>Make sure the input paper feed sensors are working properly. A stuck or incorrectly installed sensor causes this error.</p>

Paper picks during POST and/or continuously

FRU	Action
ACM (auto comp mechanism or paper feed) clutch Manual feed clutch	<p>Check the ACM clutch for wear. The solenoid interacts with the clutch to control the motion of the pick tires.</p> <p>If the ratchet teeth of the ACM clutch assembly are worn or broken, the solenoid may not stop the ACM from rotating. Replace the ACM clutch assembly if necessary.</p> <p>Check the manual feed clutch for the same damage.</p>

Paper picks but stops half way through the printer

FRU	Action
Input sensor #1 (under print cartridge assembly) and Input sensor #2 (manual)	<p>Make sure the input sensors are working properly.</p> <p>Check for a broken or stuck flag on the input sensors.</p> <p>Make sure the cables are seated on the controller card at J20 (Tray 1 input) and J18 (manual input).</p> <p>Check for less than +5 V dc on pin 3 at J20 (Tray 1 input) and pin 1 at J18 (manual input sensor).</p> <ul style="list-style-type: none"> • If correct, replace the input paper feed sensor. • If these voltages are not correct, replace the controller card.

Paper never picks

FRU	Action
Paper feed (pick tires)	Open the left cover and verify the solenoid and clutch are functioning when an attempt is made to feed the paper. Make sure the rubber tires are installed and clean. Replace if necessary.



Paper occasionally picks or picks multiple sheets at once

FRU	Action
Tray 1 Tray 2 (option)	<p>Check tray for paper catch points.</p> <p>If the sheet being fed stops momentarily, the ACM applies additional vertical force causing additional sheets to feed.</p> <p>Do not mix paper types.</p>
Paper pick tires	<p>Check the tires in the ACM assembly for signs of wear or damage.</p> <p>Replace the tires as necessary.</p>
ACM clutch complete bill of material (CBM) Manual feed clutch CBM	<p>Open left cover and observe the solenoid and clutch actions at the ACM and manual feed shafts as a print job is attempted.</p> <p>Replace the faulty part.</p>
Controller card	<p>Disconnect the solenoid cable at J5 on the controller card.</p> <p>Measure the resistance across cable pins 1 and 2 and then pins 3 and 4.</p> <ul style="list-style-type: none"> • The resistance should be 180–210 ohms. • If it is not, call the next level of service. • If the resistance is 180–210 ohms, check the controller card. See “Controller card service check” on page 2-49 for more information. <p>Replace controller card as necessary.</p>

Paper “trees,” wrinkles, stacks poorly or curls

FRU	Action
Fuser	This problem is most likely due to a worn backup roll. It causes the printer to run hotter than required for the media being printed. Excessive heat can cause paper treeing problems, poor stacking, or curl.

Parallel port service check







1. Perform a print test to make sure the printer prints correctly. Verify  is on, press  to print menu settings.
2. Be sure the printer cable is designed for bidirectional printing.
3. Be sure the user Program is set up correctly.
4. If the internal print test page prints correctly, the user Program/printer driver is set up correctly and the correct bidirectional parallel cable is installed, but the printer still fails to print on command from the host computer, replace the controller card.

Print quality service checks

Note: Ensure cover is closed tightly. A gap in the opening may allow light to expose the photoconductor resulting in a 'dirty' print.

Using print quality test pages

To help isolate print quality problems, like streaking, print test pages using the print quality test pages setting:

1. Turn the printer on with  pressed and the front door open.
2. When  light stays on, close cover.
3. Wait (approximately 7 seconds) until the printer drive activates.
4. Enter the configuration menu. See **“Configuration and diagnostic groups” on page 3-1** for more information.
5. Slowly press and release  three times until the  and  lights come on.
6. Press and hold  until all the lights flash to initiate print quality test pages.

Three pages print to help you evaluate print quality. The first page has various fonts, the second page is gray, and the third page is black. Once the paper exits into the output bin, the printer returns to the home state (four top lights on).

7. Use the test pages to isolate problems such as light or toner streaks. See **“Symptom tables” on page 2-44** for solutions to these problems.
8. To exit print quality test pages, turn the printer off.

Blank page

FRU	Action
Toner cartridge (not a FRU)	Remove the toner cartridge and gently shake it to evenly distribute the toner. Check for cartridge damage.
 <p>Printhead LVPS/HVPS Controller card Toner electrodes (cable assembly)</p>	<p>Blank pages can be caused by a defective printhead assembly, LVPS/HVPS, or controller card.</p> <ul style="list-style-type: none"> • Printhead errors typically result in printer service errors. • Blank pages typically are caused by the PC roll not being properly charged. Try a different PC kit. <p>Unplug the printer and check continuity between the LVPS/HVPS connection pads marked OPC and the corresponding pin inside the printer.</p> <ul style="list-style-type: none"> • If there is not continuity, call the next level of service. <p>Try a different toner cartridge and PC kit.</p> <ul style="list-style-type: none"> • If those fail, replace the LVPS/HVPS.

Black page

Note: Incorrect laser exposure or incorrect charging of the photoconductor causes an all black page. Always verify the same results from a different print cartridge assembly and developer before proceeding.

FRU	Action
Toner electrodes (not a FRU)	<p>Check the electrodes below the print cartridge assembly for contamination or damage. Correct as necessary.</p> <p>Check continuity between the cable connections on the contact tips below the print cartridge assembly.</p> <ul style="list-style-type: none"> • If continuity fails, call the next level of service.
 <p>LVPS/HVPS board Controller card</p>	<p>With the printer off, disconnect the LVPS/HVPS cable from J7 on the controller card.</p> <p>Turn the printer on and verify +24 V dc on pin 8 of the cable.</p> <p>Verify ground on pin 7.</p> <ul style="list-style-type: none"> • If the voltage is incorrect, replace LVPS/HVPS board. • If voltage is correct and the toner electrodes are good, replace the controller card.

Heavy background

Poor development or poorly charged toner particles cause excessive background. This is more noticeable as the toner cartridge nears end-of-life.

FRU	Action
Toner cartridge (not a FRU) PC Kit (not a FRU)	<p>Make sure the toner cartridge and PC Kit are correctly installed and the high voltage contacts are clean.</p> <p>If the toner cartridge and PC Kit are installed correctly, try a new PC Kit first and then toner cartridge.</p>
 <p>LVPS/HVPS Controller card</p>	<p>Check the contacts for correct installation and contamination where contact is made between the print cartridge assembly, and LVPS/HVPS board. Clean as necessary.</p> <p>If this does not correct the problem, replace the following FRUs one at a time in the order shown:</p> <ul style="list-style-type: none"> • LVPS/HVPS board • Controller card

Partial blank image/white spots (no periodic pattern)

FRU	Action
Toner cartridge (not a FRU)	<p>Remove the toner cartridge assembly and gently shake the assembly to evenly distribute the toner.</p> <p>If toner cartridge is low, try a new one.</p>
Paper (not a FRU)	<p>Make sure recommended paper is being used.</p>

Variation in image density horizontally across page

FRU	Action
PC Kit (not a FRU)	<p>The charge roll may have an unbalanced pressure against the Photoconductor (PC) drum.</p> <p>Try a new PC Kit.</p>
Transfer roll	<p>Check the springs in the left and right transfer roll bearings. The bearing assemblies should support the transfer roll, applying even pressure to the PC drum.</p> <p>Replace the transfer roll assembly if the springs or bearing show signs of damage or fatigue.</p> <p>Inspect the transfer roll for signs of wear, damage or contamination.</p> <p>Replace as necessary.</p>

Poor fusing of image

FRU	Action
Fuser	The fuser may not be operating at the proper temperature to fuse the toner to the paper. See “Hot fuser service check” on page 2-56 for more information.
Paper (not a FRU)	Make sure recommended paper is being used.

Light print

FRU	Action
Toner cartridge (not a FRU)	<p>Make sure the toner cartridge and PC Kit are installed correctly and that the toner cartridge is not low on toner.</p> <p>If the problem continues, install a new toner cartridge.</p> <p>Recheck condition before replacing PC Kit, if necessary.</p>
 Transfer roll LVPS/HVPS board	<p>Check the transfer roll for signs of toner buildup and contamination.</p> <p>Inspect the HVPS contact (transfer roll) for contamination.</p> <p>Verify the high voltage cable is plugged into the LVPS/HVPS.</p> <p>If all components appear free of contamination, replace the following FRUs one at a time in the order shown:</p> <ul style="list-style-type: none"> • Transfer roll • LVPS/HVPS board

White or black lines or bands





FRU	Action
<p>Print cartridge assembly (not a FRU)</p> <p>Developer drive coupling assembly</p>	<p>Banding appears as light or dark horizontal lines on a uniformly gray page or on a page with a large area of graphics. Banding is primarily due to a variation in the speed of the paper as it feeds through the printer especially in the developer and transfer process.</p> <p>Inspect the toner cartridge and paper feed components, especially the drive coupler and drive gears for debris, binds or damage.</p>

Toner on back of page

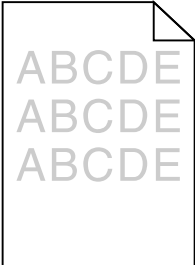
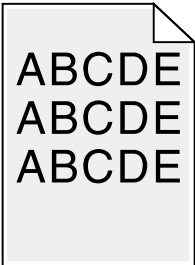
FRU	Action
PC Kit (not a FRU)	<p>Inspect the overall paper path for signs of spilled toner.</p> <p>Gently clean the contaminated areas with a soft cloth or compressed air.</p>
Fuser	<p>The fuser hot roll can cause toner deposits on the back of the paper if toner is building up on the hot roll. This buildup may transfer to the backup roll, later transferring to the back of the paper.</p> <p>Inspect the hot roll and backup roller for signs of contamination.</p> <p>Replace the fuser as necessary.</p>
Transfer roll	<p>A transfer roll contaminated with toner can cause toner to transfer to the back of printed pages.</p> <p>Inspect the transfer roll for contamination and replace as necessary.</p>

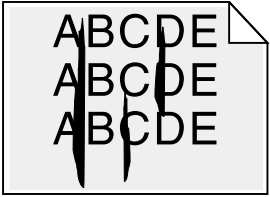
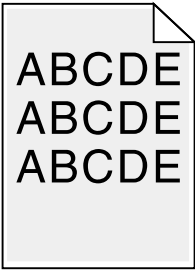
Solving print quality problems



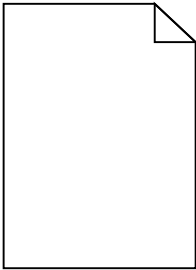

Problem	Action
<p>Light or blurred characters.</p> 	<p>Light print</p> <p>The toner cartridge may be getting low on toner:</p> <ul style="list-style-type: none"> • Remove the toner cartridge and print cartridge assembly. • Shake it from side to side to redistribute the toner. • Reinstall it and recheck for condition. • Make sure you are using recommended print media (see media types and sizes in the <i>User's Reference</i>.) • Use MarkVision™ to define the custom type setting for media type, media texture, or media weight. • The toner cartridge or PC Kit may be defective. Replace the PC Kit first and recheck. <p>Blurred characters</p> <p>Blurred images, including characters, are usually caused by a defective printhead. See “Light print” on page 2-71.</p>
<p>Toner smudges appear on the front or back of the page.</p> 	<ul style="list-style-type: none"> • Make sure the paper is straight and unwrinkled. • Replace the PC Kit and recheck before replacing the toner cartridge. See “Toner on back of page” on page 2-72 for more information.

Problem	Action
<p>Vertical or horizontal streaks appear on the page.</p> 	<p>Replace the toner cartridge for vertical black streaks.</p> <p>Wipe the glass lens clean with a soft tissue for vertical “white” streaks.</p> <p>For horizontal streaks, see “White or black lines or bands” on page 2-72 for more information.</p>
<p>Toner smears or rubs off the page.</p> 	<ul style="list-style-type: none"> • Replace the fuser. The toner is not being fused. See “Cold fuser service check” on page 2-47 for more information. • Try a different kind of paper. Paper designed for copiers gives the best quality fusing. • If you are printing on special media, such as card stock or labels, be sure you select the correct paper type in the printer driver. • Change the media texture setting. If the setting is not in your driver, you can download the correct Lexmark setup utility from the Lexmark Web site at www.lexmark.com.
<p>The print is getting light but the /☺ light is not on.</p>	<ul style="list-style-type: none"> • The /☺ light does not come on if the standard 1,500 page toner cartridge is installed. • Remove the toner cartridge and gently shake it from side to side to redistribute the toner. • Replace the toner cartridge.
<p>The /☺ light is on.</p>	<ul style="list-style-type: none"> • Remove the toner cartridge and gently shake it from side to side to redistribute the toner. • Replace the toner cartridge.

Problem	Action
<p>Solid black areas on transparencies or white streaks on paper.</p>	<ul style="list-style-type: none"> • Choose a different fill pattern in your software Program. • Try a different type of paper. Paper designed for copiers gives the best quality. • Remove the toner cartridge and gently shake it from side to side to redistribute the toner. • Replace the toner cartridge.
<p>Faint images or repetitive spots appear on the page.</p>	<ul style="list-style-type: none"> • Select a different media type or form type setting from your printer driver. • Try a different type of paper. Paper designed for copiers gives the best quality. • Replace the toner cartridge.
<p>Pages are blank.</p> 	<ul style="list-style-type: none"> • The print cartridge may be out of toner or defective. Replace the cartridge. • You may have a software error. Try turning the printer off and back on. • Check the printhead. See “Paper feed service checks” on page 2-61 for more information.

Problem	Action
<p>The printer is on, but nothing prints.</p>	<ul style="list-style-type: none"> • Make sure the toner cartridge assembly is installed properly. • Make sure the parallel or USB cable is not damaged and is firmly plugged into the connector on the back of the printer. • Press and release  to print a menu settings page just to save space. <ul style="list-style-type: none"> – If you cannot print a menu settings page, call the next level of support. – If you can print a menu settings page, the problem is one of the following: <ul style="list-style-type: none"> • Computer • Software program • Cable • (USB only) failed ASIC or controller card. Replace card. <p>Note: Test by unplugging USB and replugging it with the printer on. If the computer indicates “unknown device,” replace the card.</p>
<p>Toner Low light is on and printing stops.</p>	<p>If you are using a 3000 or 6000 toner cartridge and the Toner Low alarm is set to on, the printer stops printing until you replace the toner cartridge.</p> <ul style="list-style-type: none"> – Download the correct Lexmark setup utility from the Lexmark Web site at www.lexmark.com to change the Toner Low alarm.
<p>The Error light is on.</p>	<p>Make sure the printer cover is closed.</p>
<p>The Toner Low light is blinking, and the Error light is on.</p>	<ul style="list-style-type: none"> • Make sure the toner cartridge is installed correctly. • Install a new toner cartridge.

Problem	Action
The media skews or buckles.	<ul style="list-style-type: none"> • Don't overfill Tray 1 or the optional Tray 2 (see media capacities in the media types and sizes table in the <i>User's Reference</i>). • Make sure the paper guides are flush against the edges of the media.
The paper sticks together/printer feeds multiple sheets of paper.	<ul style="list-style-type: none"> • Remove the paper from Tray 1 or the optional Tray 2 and fan it. • Don't overfill Tray 1 or the optional Tray 2 (see media capacities in the media types and sizes chart in the <i>User's Reference</i>).
The paper fails to feed from Tray 1.	<ul style="list-style-type: none"> • Remove the paper from Tray 1 and fan the paper. • Make sure Tray 1 is selected from the printer driver. • Do not overfill the tray. • Check the condition of the rubber on the paper feed rolls. • Verify clutch for ACM is not slipping.
The paper fails to feed from the optional Tray 2.	<ul style="list-style-type: none"> • Make sure the optional Tray 2 is selected from the printer driver. • Make sure the tray is pushed all the way in. • Remove the paper from the optional Tray 2 and fan it. • Check the rubber on the paper feed tires. • Check the paper path in the tray for burrs or debris that may hinder paper movement. • Make sure the paper does not exceed the stack height indicator.
The Load Paper light is on even though there is paper loaded in the optional Tray 2.	<ul style="list-style-type: none"> • Make sure the tray is pushed all the way in. • Press  .

Problem	Action
The printer does not print after a paper jam has been cleared.	<ul style="list-style-type: none"> • Clear all jams. • Press and release  or open and close the printer cover to restart the printer. • Make sure the print cartridge assembly is installed properly.
Unexpected characters print or characters are missing.	<ul style="list-style-type: none"> • Ensure correct printer driver is being used. • Press and hold  until all lights come on to reset printer to user default settings. • Select hex trace mode to determine what the problem is. • Restore factory defaults. • Make sure the parallel cable or USB cable is firmly plugged in at the back of the printer.
Jobs are not printing and the Error light is on solid.	<ul style="list-style-type: none"> • Make sure the print cartridge assembly is installed properly. • Make sure the printer top cover is closed.
While in PostScript 3 emulation, the printer is flushing data (Ready/Data and Error lights are blinking).	<ul style="list-style-type: none"> • Ensure the correct PostScript driver is being used. • The printer doesn't have enough memory to print the job. Install more memory.
While using manual duplex, the printer gets a paper jam.	<p>A paper jam interrupts the duplex process. As a result, the information on the page that jammed is lost.</p> <ul style="list-style-type: none"> • Press and release  to cancel the print job. • Press and hold  (approximately 3 seconds) to reset the printer. • Resend the print job.

Transfer roll service check

FRU	Action
 <p data-bbox="139 415 267 440">Transfer roll</p>	<p data-bbox="546 277 905 329">Check transfer roll area for debris and clean as necessary.</p> <p data-bbox="546 342 929 418">Verify continuity between the spring below the left side bearing and the transfer roll shaft.</p> <p data-bbox="546 431 937 508">Verify continuity in the spring and the cable connection on the LVPS/HVPS.</p> <ul data-bbox="575 521 937 605" style="list-style-type: none"><li data-bbox="575 521 937 605">– Inspect the roll for signs of wear or damage and replace if necessary.

3. Diagnostic aids

Configuration and diagnostic groups

Configuration

The configuration group contains a set of menus, settings, and operations which are not used by an end user. Generally, the options made available in this menu group are used to configure a printer.

Access to the configuration group is gained by way of a POR key sequence. See **“Accessing the configuration and diagnostic groups” on page 3-2** for more information.

Diagnostic





The diagnostic group contains menu settings and operations that are useful in the manufacturing of the printer. It also features other aids in diagnosing problems. See **“Accessing the configuration and diagnostic groups” on page 3-2** for more information.

Accessing the configuration and diagnostic groups

Power-On operations

To access printer operations:





1. Turn off the printer.
2. Open the front cover.
3. Press and hold the buttons in the following table for the operation needed.

Operation	Power-on action
Enter configuration menu mode	<ol style="list-style-type: none"> 1. Power on with cover open and  pressed. 2. Close cover once the ! light is displayed.
Enter diagnostics mode	<ol style="list-style-type: none"> 1. Power on with top cover open and  pressed. 2. Close cover once the ! light is displayed.
Reset NVRAM and enter normal mode	<ol style="list-style-type: none"> 1. Power on with top cover open and both  and  buttons pressed. 2. Close cover once the ! light is displayed.

4. Turn on the printer. Hold the selected button until the lights cycle on the operator panel.
5. Close the cover and wait for the printer to activate the drive.
6. Print menus by pressing and holding  until the lights flash (see menu samples on [page 3-4](#) and [page 3-5](#)).

Moving around the menu

“Printer settings configuration” on page 3-4 and **“Printer diagnostics” on page 3-5**, are similar to the instructions printed by following steps 1-6 on **page 3-2**. These menu items are designated by the non-indented items listed along the left edge of the page. (Bottom as printed from printer.) These items are also un-shaded.

- Press and release  to move sequentially from one menu item to another.
- Press and hold  to jump to home state (top four lights on).
- Press and release  to move through the menu settings (indicated by  and  lights).

This action rotates only through the possible settings of the selected menu item.

Printer settings configuration

Printer Settings Configuration

This page explains how to access the printer menus and change values. Menus are represented by Continue, Ready/Data, Toner Low, and Load/Remove Paper light sequences. Menu items and their values are indicated by Paper Jam and Error light sequences.

Use the illustration to help you find the menu and value you want to change. The Paper Jam and Error lights show the current value of the menu item.

- 1 Press and release Continue to advance through the menus and menu items to the one you need.
 - 2 Press and release Continue to advance to the value you need.
 - 3 Press and hold Continue until all of the lights cycle to perform the function or to save the value.
 - 4 Press and hold Cancel until all of the lights cycle to return to the Home menu.
 - 5 Turn the printer off to exit the menus.
- Menus, menu items, and values

	Utilities	Setup	Parallel	USB	Network
Press Continue	●	○	○	○	○
Ready/Data	○	○	○	○	○
Toner Low	○	○	○	○	○
Load Paper	○	○	○	○	○
Paper Jam	○	○	○	○	○
Error	○	○	○	○	○
Print Configuration Mode Instructions	○	○	○	○	○
Reset Factory Defaults	○	○	○	○	○
Hex Trace = Off	○	○	○	○	○
On	○	○	○	○	○
Print Quality Test Pages	○	○	○	○	○
Reset Photoconductor Counter	○	○	○	○	○
PPDS Emulation = Deactivate	○	○	○	○	○
Deactivate	○	○	○	○	○
Activate	○	○	○	○	○
Demo Mode = Deactivate	○	○	○	○	○
Deactivate	○	○	○	○	○
Activate	○	○	○	○	○
Auto CR after LF = Off	○	○	○	○	○
Off	○	○	○	○	○
On	○	○	○	○	○
Auto LF after CR = Off	○	○	○	○	○
Off	○	○	○	○	○
On	○	○	○	○	○
NPA Mode = Auto	○	○	○	○	○
On	○	○	○	○	○
Off	○	○	○	○	○
Auto	○	○	○	○	○
Protocol = Fastbytes	○	○	○	○	○
Standard	○	○	○	○	○
Fastbytes	○	○	○	○	○
Parallel Mode 2 = On	○	○	○	○	○
Off	○	○	○	○	○
On	○	○	○	○	○
MAC Binary PS = Auto	○	○	○	○	○
On	○	○	○	○	○
Off	○	○	○	○	○
Auto	○	○	○	○	○
NPA Mode = Auto	○	○	○	○	○
On	○	○	○	○	○
Off	○	○	○	○	○
Auto	○	○	○	○	○
MAC Binary PS = Auto	○	○	○	○	○
On	○	○	○	○	○
Off	○	○	○	○	○
Auto	○	○	○	○	○
NPA Mode = Auto	○	○	○	○	○
Off	○	○	○	○	○
Auto	○	○	○	○	○
MAC Binary PS = Auto	○	○	○	○	○
On	○	○	○	○	○
Off	○	○	○	○	○
Auto	○	○	○	○	○
Set Card Speed = Auto	○	○	○	○	○
Auto	○	○	○	○	○
10 Mbps, Half Duplex	○	○	○	○	○
10 Mbps, Full Duplex	○	○	○	○	○
100 Mbps, Half Duplex	○	○	○	○	○
100 Mbps, Full Duplex	○	○	○	○	○

- Light On
- Light Off
- ◐ Light Blinking
- ◑ Value

Printer diagnostics

Printer Diagnostics

This page explains how to access the printer menu and change values. Menus are represented by Continue, Ready/Data, Toner Low, and Load/Remove Paper light sequences. Menu items and their values are indicated by Paper Jam and Error light sequences.

- 1 Press and release Cancel to advance through the menus and menu items to the one you need.
 - 2 Press and release Continue to advance to the value you need.
 - 3 Press and hold Continue until all of the lights cycle to perform the function or to save the value.
 - 4 Press and hold Cancel until all of the lights cycle to return to the Home menu.
 - 5 Turn the printer off to exit the menus.
- Menus, menu items, and values

	Development	Parallel	Network
Press Continue	●	○	○
Ready/Data	○	○	○
Toner Low	○	○	○
Load Paper	○	○	○
Paper Jam	○	○	○
Error	○	○	○
Print Diag Inst	○	○	○
Edge to Edge = Off	○	○	○
Off	○	○	○
On	○	○	○
Prt Quality Pgs	○	○	○
Cont Prt Simplex Tray 1	○	○	○
Print History	○	○	○
Defaults = U.S.	○	○	○
U.S.	○	○	○
Non-U.S.	○	○	○
Configuration ID = 000112	○	○	○
000112	○	○	○
00019A	○	○	○
Par S Strobe Adj = 0	○	○	○
-1	○	○	○
0	○	○	○
1	○	○	○
2	○	○	○
3	○	○	○
History	○	○	○
Mark History = Do Not Mark	○	○	○
Mark	○	○	○
Do Not Mark	○	○	○
History Mode = Modified	○	○	○
Modified	○	○	○
Every Time	○	○	○
Dump NVRAM	○	○	○
Reinit NVRAM	○	○	○
Optra Forms Mode = Off	○	○	○
On	○	○	○
Off	○	○	○
Meditech Mode = No	○	○	○
Yes	○	○	○
No	○	○	○

- Light On
- Light Off
- ⊛ Light Blinking
- Value

Configuration menu selections

Utilities

Use the Utilities menu to troubleshoot printer problems.

Setting	Use setting to:	Values
Reset Factory Defaults	<p>Return the printer settings to factory default values.</p> <p>Sometimes resetting the printer to the original settings solves formatting problems.</p> <p>All menu items are reset to the factory default values except:</p> <ul style="list-style-type: none"> • Display Language. • All settings in the Parallel menu, Network menu, LocalTalk menu, and USB menu. • All downloaded resources (fonts, macros, and symbol sets) in printer memory (RAM) are deleted. <p>Resources in flash memory are unaffected.</p>	
Hex Trace	<p>Help isolate printing problems when unexpected characters print or characters are missing.</p> <p>Hex Trace helps determine if there is a problem with the language interpreter or the cable by providing information about what the printer is receiving.</p> <p>To exit Hex Trace, turn off the printer.</p>	<p>Off*</p> <p>On</p>
Print Quality Test Pages	<p>Help isolate print quality problems, such as streaking. Three pages print to help evaluate print quality:</p> <ul style="list-style-type: none"> • A text page with printer information, cartridge information, current margin settings, and a graphic. • Two pages with graphics. 	

Setting	Use setting to:	Values
Reset Photoconductor Counter	Return the photoconductor counter to zero. The replace photoconductor message should be cleared <i>only</i> when the photoconductor kit has been replaced.	
* Factory default		

Setup

Use the Setup menu to configure how the printer formats the end of a line depending on the computer system being used.

Menu item	Use setting to:	Values
Demo mode	Put printer into demo mode where internal sheets prints with each press of \diamond . To deactivate, turn the printer off and re-enter configuration group. Set to deactivate.	Deactivate* Activate
Auto CR after LF	Specify whether the printer automatically performs a carriage return after a line feed control command.	Off* On
Auto LF after CR	Specify whether the printer automatically performs a line feed after a carriage return control command.	Off* On
* Factory default		

Parallel

Use the Parallel menu to change printer settings on jobs sent through a parallel port.

Menu item	Use setting to:	Values
NPA Mode	Send print jobs to the printer and query printer status information simultaneously.	Off On Auto*
Protocol	Receive information at a much higher transmission rate if your printer is set to Fastbytes (if your computer supports Fastbytes) or receive information at a normal transmission rate if your printer is set to Standard.	Standard Fastbytes*
Parallel Mode 2	Determine whether the parallel port data is sampled on the leading (On) or trailing (Off) edge of strobe.	Off On*
MAC Binary PS	Configure the printer to process Macintosh binary PostScript print jobs.	Off—The printer filters PostScript print jobs using Standard protocol. On—The printer processes raw binary PostScript print jobs from computers using the Macintosh operating system. This setting often causes Windows print jobs to fail. Auto*—The printer processes print jobs from computers using either Windows or Macintosh operating systems.
* Factory default		

USB

Use the USB menu to change printer settings on jobs sent through a USB port.

Menu item	Use setting to:	Values
NPA Mode	Send print jobs to the printer and query printer status information simultaneously.	Off On Auto*
MAC Binary PS	Configure the printer to process Macintosh binary PostScript print jobs.	Off—The printer filters PostScript print jobs using Standard protocol. On—The printer processes raw binary PostScript print jobs from computers using the Macintosh operating system. This setting often causes Windows print jobs to fail. Auto*—The printer processes print jobs from computers using either Windows or Macintosh operating systems.
* Factory default		

Network

Use the network menu to change printer settings on jobs sent through a network port (either standard network or network opt <x>).

Menu item	Use setting to:	Values
NPA Mode	Send print jobs to the printer and query printer status information simultaneously.	Off Auto*
MAC Binary PS	Configure the printer to process Macintosh binary PostScript print jobs.	<p>Off—The printer filters PostScript print jobs using Standard protocol.</p> <p>On—The printer processes raw binary PostScript print jobs from computers using the Macintosh operating system. This setting often causes Windows print jobs to fail.</p> <p>Auto*—The printer processes print jobs from computers using either Windows or Macintosh operating systems.</p>

Network (continued)

Menu item	Use setting to:	Values
Set card speed	<p>Automatically detect the connection speed of your network.</p> <p>This setting can be disabled to set the speed manually.</p>	<p>Auto* – the printer detects current network speed.</p> <p>10Mbps, half duplex– forces the printer to try to connect to the network only at 10Mbps, half duplex.</p> <p>10Mbps, full duplex– forces the printer to try to connect to the network only at 10Mbps, full duplex.</p> <p>100Mbps, half duplex– forces the printer to try to connect to the network only at 100Mbps, half duplex.</p> <p>100Mbps, full duplex– forces the printer to try to connect to the network only at 100Mbps, full duplex.</p>
* Factory default		

Diagnostics menu selections

Development

Menu item	Use setting to:	Value
Edge-to-edge	Allow a shift of all four margins (top, bottom, right and left) to the physical edge of the page (printable area of supported paper). Setting ignored by PPDS interpreter.	Off* On
Print quality test pages	Help isolate print quality problems, such as streaking. Three pages print: <ul style="list-style-type: none"> • A text page with printer information, cartridge information, current margin settings, and a graphic. • Two pages with graphics. Note: Cartridge lockout function disabled.	
Continuous print - simplex Tray 1	Continuously print pages containing cross lines, printer information and margin settings. Press  to stop.	
Print history	Print history of errors.	
Defaults	Change sizes and designations to metric.	U.S.* Non-U.S.
Configuration ID	Allow the printer's ID to match the label's ID after the controller card is replaced.	000101* 000189
* Factory default		

Parallel

Menu item	Use setting to:	Value
Par S strobe adjustment	Adjust for an unusually long parallel cable. (Parallel mode 2 only is supported and can be turned off in the configuration group.)	-1 0* 1 2 3
* Factory default		

Network

Menu item	Use setting to:	Value
Mark history	Append a tag to the history report to indicate the most recent crashes.	Mark Do not mark*
History mode	Post the 976 error code to the user each time it occurs. The default (modified) internally resets the posting but records it in the crash history. A substantial number of consecutive errors result in posting 976.	Modified* Every time
Dump NVRAM	Print a hex dump if the network NVRAM partition.	
Reinit NVRAM	Rest the network NVRAM to factory defaults.	
Optra Form mode	Treat all print jobs as Optra Forms™ jobs.	On Off*
Meditech mode	Prevent the network card from accepting more than one 9100 mode connections at a time.	Yes No*
* Factory default		

4. Repair information

Removals

Note:

1. Remove the toner cartridge and paper tray before removing other printer parts. The toner cartridge should be protected from light while out of the printer.
2. We recommend all external cables be disconnected from the printer to prevent damage during service.
3. Unless otherwise stated, re-install the parts in reverse order of removal.
4. When re-installing a part held with several screws, start all screws before final tightening.

Covers

Access cover removal

(See “Covers” on page 7-2.)

1. Open the front access cover.
2. Place thumbs on the inside of the respective hinge.
3. Force the left hinge out of its socket and relax it above the socket.
4. Force the right hinge out of its socket and lift it above the socket.

CAUTION: Do not pull the fuser link out of the printer any farther than when the door is fully open. Otherwise, the link extension may cause the cartridge coupler to become dislodged.

5. Carefully lift the cover free from the printer frame.
6. Use your left hand to hold the fuser link at the cover joint while rotating the right side of the cover slightly away from the printer to disengage the link.
7. Remove the access cover.

Reinstallation note: If the access cover is being replaced, remove the logo plate and use it on the new cover.

Extender cover removal

(See “Frame” on page 7-6.)

1. Locate the latches on the left and right sides of the extender cover.
2. Push the latches and pull the cover away from the rear of the printer.

Left side cover removal

(See “Covers” on page 7-2.)

1. Open the access cover to expose a screw and the two left side cover latches.
2. Remove the screw, which fastens the side cover.
3. Open the rear door (output tray).
4. Release the latches with the right hand while applying opening force with the left hand.
5. Swing the cover open.
6. To remove the cover, position the printer with the left–rear corner hanging over the edge of the table.
7. Lift the top rear of the cover over the pivot point and drop the cover away from the printer.

Rear cover removal

(See “Covers” on page 7-2.)

1. Remove the right side cover. See “Right side cover removal” on page 4-3 for more information.
2. Remove the left side cover. See “Left side cover removal” on page 4-3 for more information.
3. Open the rear door (rear exit tray) and remove the two screws holding the cover.
4. Lift the rear cover, unhook it from the frame at the bottom and remove.

Right side cover removal

(See “Covers” on page 7-2.)

Remove the right side cover the same way as the left side cover except use the opposite hand. See “Left side cover removal” on page 4-3 for more information.

Note: There is no screw holding the right cover.

Top cover removal

(See “Covers” on page 7-2.)

1. Open the access cover.
2. Open the left cover.
3. Open the right cover.
4. Remove two screws at the top rear corners of the top cover.
5. Remove two screws at the front of the top cover just behind the access door.
6. Release the top cover latch which is about 40 mm behind the access cover latch on the left side.
7. Lift and remove the top cover.

Access cover logo removal

(See “Covers” on page 7-2.)

1. Open the access cover.
2. Remove the screw holding the logo cover in place.
3. Remove the logo cover from the access cover.

Controller card removal

(See “Electronics” on page 7-4.)

Warning:

- Always touch a ground before touching the card.
 - Handle the card by the edges.
1. Open the right cover.
 2. Remove the metal controller card cover (two screws).
 3. Disconnect all the cables to the controller card.
 4. Remove three screws at the back of the printer which secure the USB and parallel ports to the metal frame.
 5. Remove five screws holding the card to the metal side frame.
 6. Carefully lift the card and remove.

Cover open sensor removal

(See **“Electronics”** on page 7-4.)

1. Remove the right side cover. See **“Right side cover removal”** on page 4-3 for more information.
2. Remove the controller card cover (two screws).
3. Disconnect the cover open switch at J13 on the controller card and extract the cable.
4. Use a small Phillips screwdriver to remove the screw holding the sensor.
5. Slide the sensor from the positioning post.

Developer drive coupling assembly removal

(See **“Frame”** on page 7-6.)

1. Remove the left side cover.
2. Carefully place the printer on its right side. Protect the cover from marring.
3. Remove four screws in the gear train metal cover.
4. Remove the developer gear, the conical spring, and the coupling assembly.

Door latch assembly removal

(See **“Frame”** on page 7-6.)

1. Open access cover.
2. Open left side cover.
3. Locate the opening on the backside of the button. The opening is partially covered by the front left edge of the printhead metal frame.
4. Use a small shank Phillips screwdriver to extract the screw.
5. Contain the spring as the latch is removed.

Exit sensor removal (on the fuser)

(See “**Electronics**” on page 7-4.)

1. Remove the paper exit guide assembly. See “**Paper exit guide assembly removal**” on page 4-12 for more information.
2. Remove the controller card cover. See “**Controller card removal**” on page 4-4 for more information.
3. Unplug the exit sensor at J10 on the controller card.
4. Locate the long shaft just above the exit sensor and two flats on the shaft just inside the bearing support at the gear.
5. Push the shaft to the right using your right thumb against the inside gear surface and the left index finger against the opposite end of the shaft.
6. Align the two flats with the opening of the bearing support and lift the right end of the shaft through the support.
7. Swing the shaft away from the printer to expose the sensor flag.
8. Remove the two lower, outermost screws holding the fuser.
9. Slide the fuser out just enough to access the screw holding the sensor.
10. Remove the sensor and its attached cable.
11. Observe the orientation of the flag and spring before replacing units.

Fan removal

(See “**Electronics**” on page 7-4.)

1. Open the right side cover.
2. Unplug the fan from the controller card at J19.
3. Remove two screws holding the fan to the metal side frame.

Feed rollers (auto comp tires) removal

(See **“Frame”** on page 7-6.)

1. Remove the paper tray.
2. Remove the toner cartridge.
3. Tilt the printer onto its back.
4. Remove old tires.
5. Ensure the new tires are captured between the rims of the plastic hub.

Fuser idle gear links removal

(See **“Frame”** on page 7-6.)

1. Remove the access cover. See **“Access cover removal”** on page 4-2 for more information.
2. Remove the left side cover.
3. Place printer on its right side. Protect the cover from being marred.
4. Remove the metal plate covering the gear train.
5. Grasp the rear link with your index fingers and thumb on each side of the shaft and unsnap the link from the shaft.
6. Disconnect front link from coupler and remove links.

Fuser power cable removal

(See **“Electronics”** on page 7-4.)



1. Remove the LVPS/HVPS card. See **“LVPS / HVPS card assembly removal”** on page 4-10 for more information.

Note: The cable can be reached without fully removing the card.

2. Remove the rear cover. See **“Rear cover removal”** on page 4-3 for more information.
3. Remove the exit guide assembly. See **“Paper exit guide assembly removal”** on page 4-12 for more information.
4. Remove the two screws (one on each side) from the lower corners of the fuser.
5. Slide the fuser out far enough to expose and disconnect the AC cable connections.
6. Extract the fuser power cable.

Fuser removal

(See **“Electronics”** on page 7-4.)



1. Remove the paper exit guide assembly. See **“Paper exit guide assembly removal”** on page 4-12 for more information.

2. Remove the two screws (one on each side) from the lower corners of the fuser.
3. Remove the controller card cover (two screws).
4. Disconnect the thermistor at J15 and exit sensor at J10 on the controller card.
5. Slide the fuser out far enough to expose and disconnect the AC cable connections.
6. Carefully extract the fuser with thermistor and sensor cables.

Input roller clutch and lever removal (ACM clutch CBM)

(See **“Frame”** on page 7-6.)

1. Remove the left side cover.
2. Place the printer on its right side. Protect the cover from being marred.
3. Remove four screws in the gear train metal cover.
4. Remove the clip from the shaft of the input roller clutch assembly.
5. Remove the screw and lever (pawl).
6. Remove the clutch assembly. If the pieces come apart, they can be easily reassembled if necessary.

Input sensor #1 removal

(See **“Electronics”** on page 7-4.)

1. Remove the right side cover. See **“Right side cover removal”** on page 4-3 for more information.
2. Remove the controller card cover.
3. Disconnect the sensor cable at J20 on the controller card (front, near top of card).
4. Carefully place the printer on its top.
5. Using a small shank screwdriver, remove the screw behind the paper pick pivot which holds the paper sensor in place.
6. Remove the sensor and the attached cable, flag, and spring.
7. Re-install the sensor so that the flag is spring loaded against the pages as it advances in its path.
8. Verify the cable is captured and out of the paper path.

Input sensor #2 (manual) removal

(See **“Electronics”** on page 7-4.)

1. Open the right side cover. See **“Right side cover removal”** on page 4-3 for more information.
2. Remove the controller card cover.
3. Disconnect the sensor cable at J18 on the controller card (front, top of card).
4. Carefully place the printer on its top, with the front facing you.
5. Remove the screw beside the left pick tire.
6. Remove the sensor and its attached cable.
7. Re-install the new sensor in the same orientation as the old. The flag should be spring loaded against the leading edge of an advancing sheet.
8. Verify the cable is captured and away from the paper path.

LVPS / HVPS card assembly removal

(See **“Electronics”** on page 7-4.)



1. Remove the cover extender (if installed) and the rear cover. See **“Rear cover removal”** on page 4-3 for more information.
2. Place the printer onto its top, with the back and bottom in view.
3. Remove two screws, one left of the power switch and the other at the opposite side of the panel.
4. Remove the foot-brackets (2x) above the power supply cover.
5. Remove four screws in the bottom of the metal cover.
6. Move the cover so the connecting cables can be unplugged.
7. Remove the LVPS/HVPS card and cover.

LVPS / HVPS to controller card cable removal

(See “**Electronics**” on page 7-4.)

1. Remove the LVPS/HVPS card. See “**LVPS / HVPS card assembly removal**” on page 4-10 for more information.
2. Remove the controller card cover. See “**Controller card removal**” on page 4-4 for more information.
3. Unplug the cable at J7 and extract the cable.

Note: The card may not have to be completely removed to disconnect the cable.

Manual feed clutch assembly removal

(See “**Frame**” on page 7-6.)

1. Remove the left side cover.
2. Place the printer on its right side. Protect the cover from being marred.
3. Remove the four screws in the gear train metal cover.
4. Remove the clip from the shaft of the pick up clutch assembly.
5. Remove the screw and lever (pawl).
6. Remove the clutch assembly. If the pieces come apart, they can be easily reassembled if necessary.

Operator panel removal

(See “**Electronics**” on page 7-4.)

1. Open access door.
2. Open the right cover.
3. Remove the controller card cover.
4. Unplug the operator panel from the controller card at J16.
5. Remove two screws at the front top and bottom of the operator panel.
6. Remove the operator panel.

Paper exit guide assembly removal

(see “**Frame**” on page 7-6.)

1. Remove the rear cover. See “**Rear cover removal**” on page 4-3 for more information.
2. Remove the three screws holding the exit guide.
3. Remove the paper exit guide assembly.

Reinstallation note: It may be necessary to rotate the gears to mesh with the fuser and drive gear.

Printhead removal

(See “**Electronics**” on page 7-4.)

1. Remove the top cover. See “**Top cover removal**” on page 4-4 for more information.
2. Remove the controller card cover (two screws).
Note: Notice the alignment of the printhead at each screw.
3. Unplug the printhead cables at locations J11 and J12.
4. Remove three screws securing the printhead to the cross brace and lift the printhead out.

Toner level sensor cable removal

(See “**Electronics**” on page 7-4.)

1. Open the right side cover. See “**Right side cover removal**” on page 4-3 for more information.
2. Remove the controller card cover (two screws).
3. Unplug the sensor at J17 and extract the cable.

Toner level sensor removal

(See “**Electronics**” on page 7-4.)

1. Open the right side cover. See “**Right side cover removal**” on page 4-3 for more information.
2. Unplug the cable from the sensor.
3. Unsnap the toner level sensor from the frame and remove through the inside of the printer.

Transfer roll removal

(See “**Frame**” on page 7-6.)

1. Open the access cover.
2. At the right side of the transfer roll, squeeze the holder arms with the left hand while lifting with the right. Stop when the holder is unlatched.
3. At the left side of the transfer roll, squeeze the holder arms with the right hand while lifting with the left hand. Stop when the left holder is unlatched.
4. With a hand at each end, lift the transfer roll out. The springs should remain in place.

Re-installation note: Verify the springs are inserted into the bearings when re-installing.

Transport motor cable removal

(See **“Electronics”** on page 7-4.)



1. Remove the right cover. See **“Right side cover removal”** on page 4-3 for more information.
2. Remove the controller card cover. See **“Controller card removal”** on page 4-4 for more information.
3. Unplug the transport motor cable (XPRT) at J9.
4. Remove the LVPS/HVPS card assembly. See **“LVPS / HVPS card assembly removal”** on page 4-10 for more information.
5. Extract the cable through the side frame leaving it free at the opening above the LVPS/HVPS.
6. Remove the fuser. See **“Fuser removal”** on page 4-8 for more information.
7. Extract the cable through the hole and from its retainers.
8. Unplug the cable at the motor and install the new cable.

5. Connector locations

Front and rear views

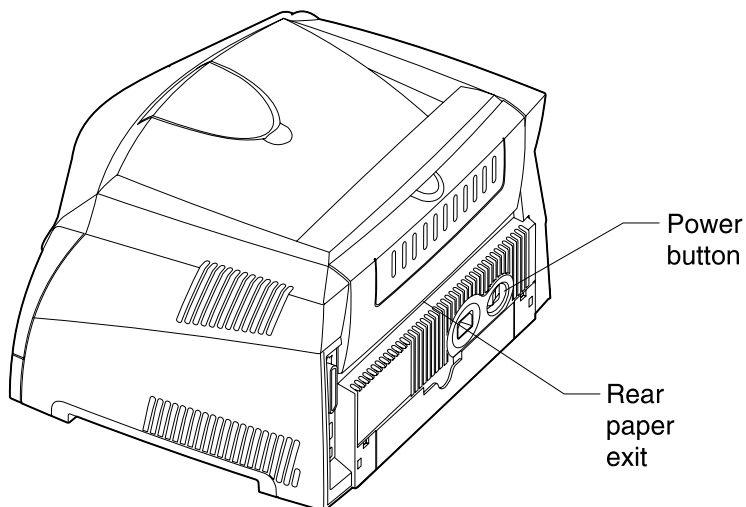
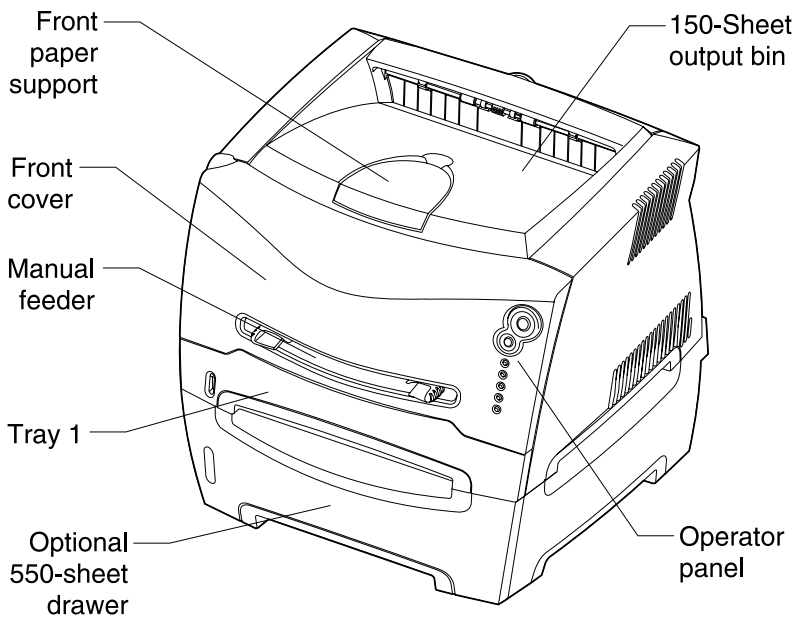

Power supply board

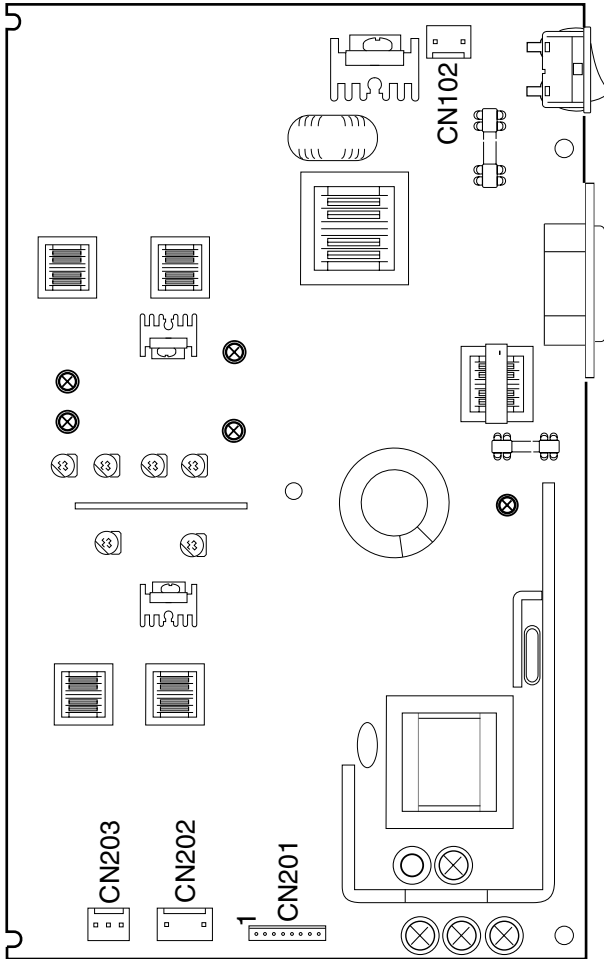

Controller board

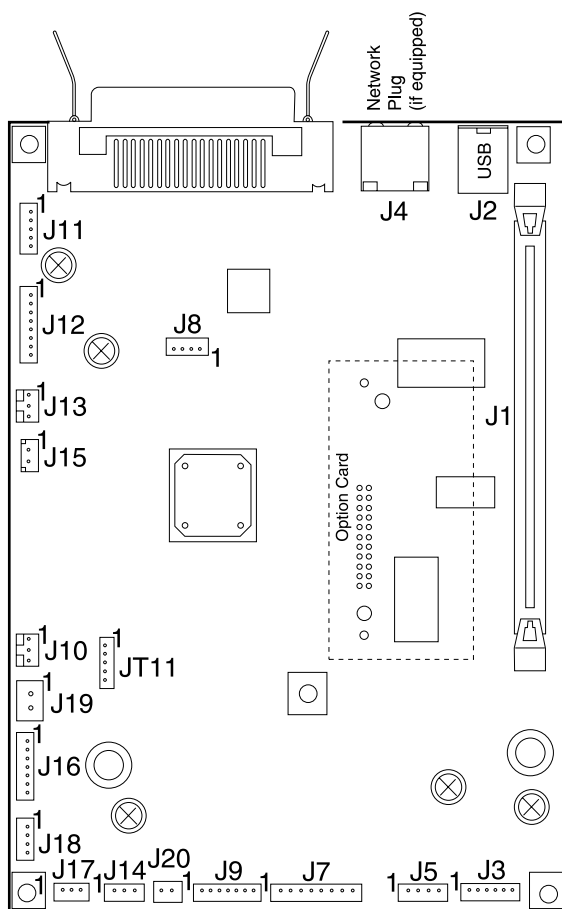

Wiring diagram

Note: See the fold out wiring diagram in the back of this book for a larger view.

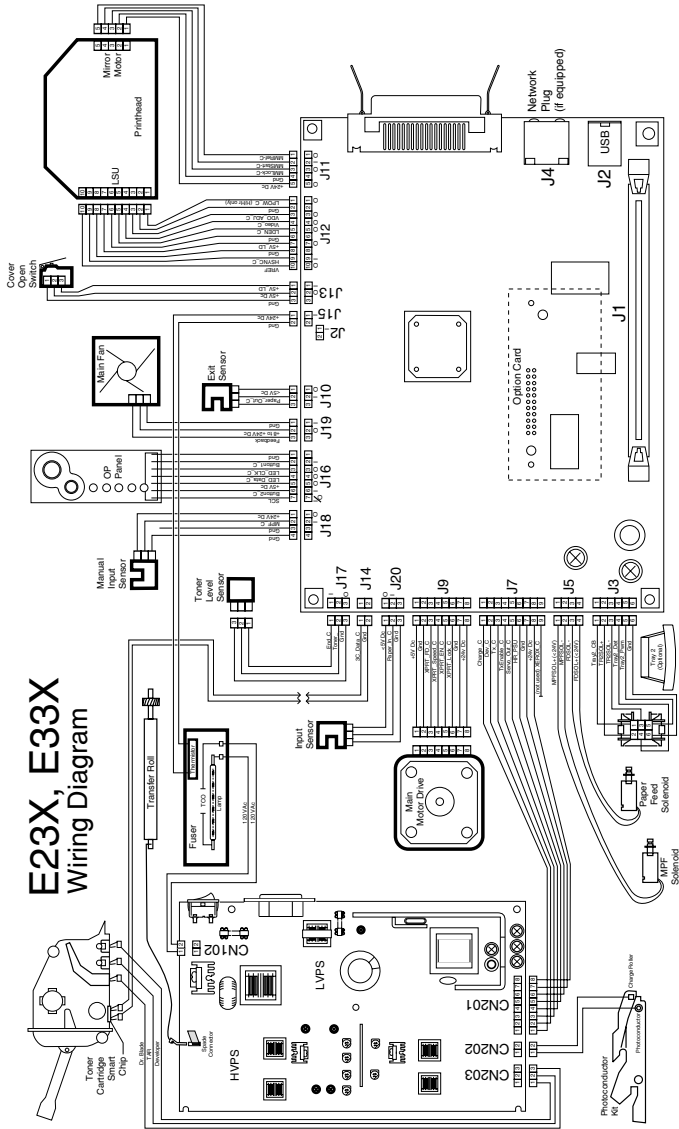

6. Preventive maintenance

The Lexmark E23x, E33x do not require preventive maintenance.

7. Parts catalog

How to use this parts catalog

SIMILAR ASSEMBLIES: If two assemblies contain a majority of identical parts, they are shown on the same list. Common parts are shown by one index number. Parts peculiar to one or the other of the assemblies are listed separately and identified by description.

- **NS:** (Not Shown) in the Asm-Index column indicates that the part is procurable but is not pictured in the illustration.

Assembly 1: Covers

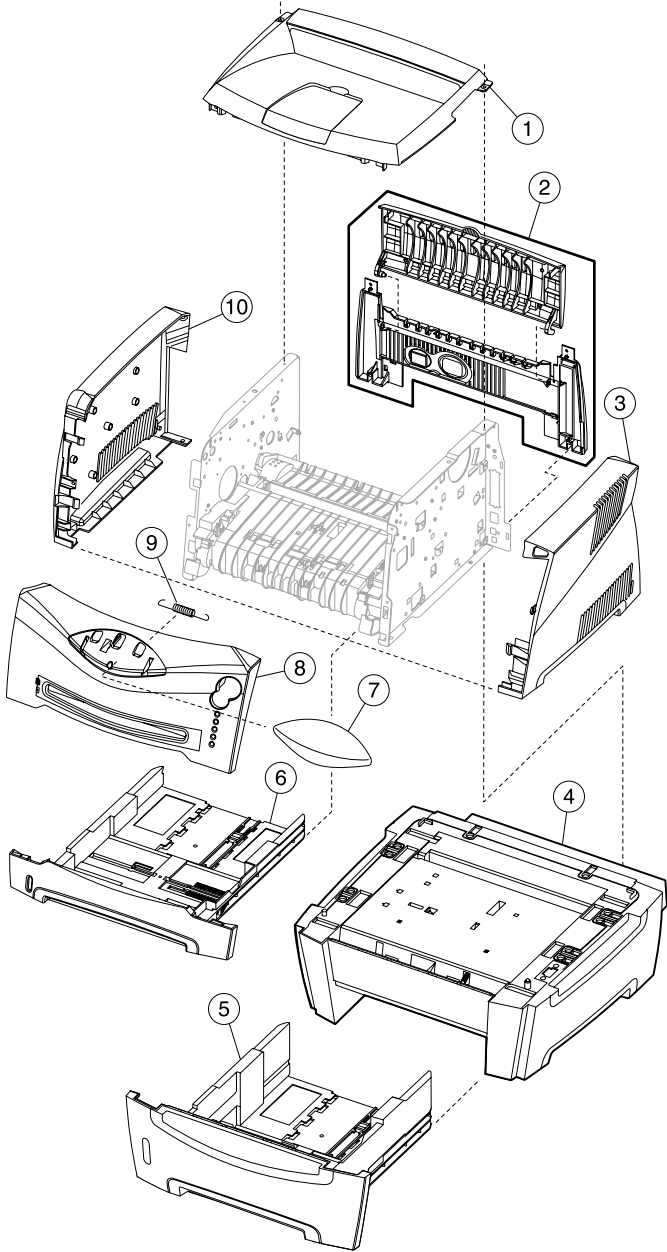

Assembly 1: Covers

Index	P/N	Units	Description
1—1	56P2079	1	Cover assembly, top
2	56P2087	1	Cover assembly, rear
2	56P2098	1	Cover assembly, rear (white)
3	56P1821	1	Cover, right
3	56P2093	1	Cover, right (white)
4	56P2089	1	Drawer, optional
5	56P2090	1	Tray 2, optional
5	56P2084	1	Tray 2, optional (white)
6	56P2088	1	Tray, main
6	56P1834	1	Tray, main (white)
7	56P1832	1	Cover, logo plate E332n
7	56P2081	1	Cover, logo plate E330
7	56P2085	1	Cover, logo plate E232
7	56P1833	1	Cover, logo plate E230
7	56P2086	1	Cover, logo plate (plain)
7	56P2628	1	Cover, logo plate (white) E230
7	56P2096	1	Cover, logo plate (white) E330
7	56P2097	1	Cover, logo plate (white) E232
7	56P2629	1	Cover, logo plate (white) E332
7	56P2703	1	Cover, logo plate E234
8	56P1816	1	Cover assembly, front access (no logo)
8	56P2091	1	Cover assembly, front access (white)
9	56P2647	1	Springs, front door and ACM
10	56P2080	1	Cover, left
10	56P2095	1	Cover, left (white)

Assembly 2: Electronics

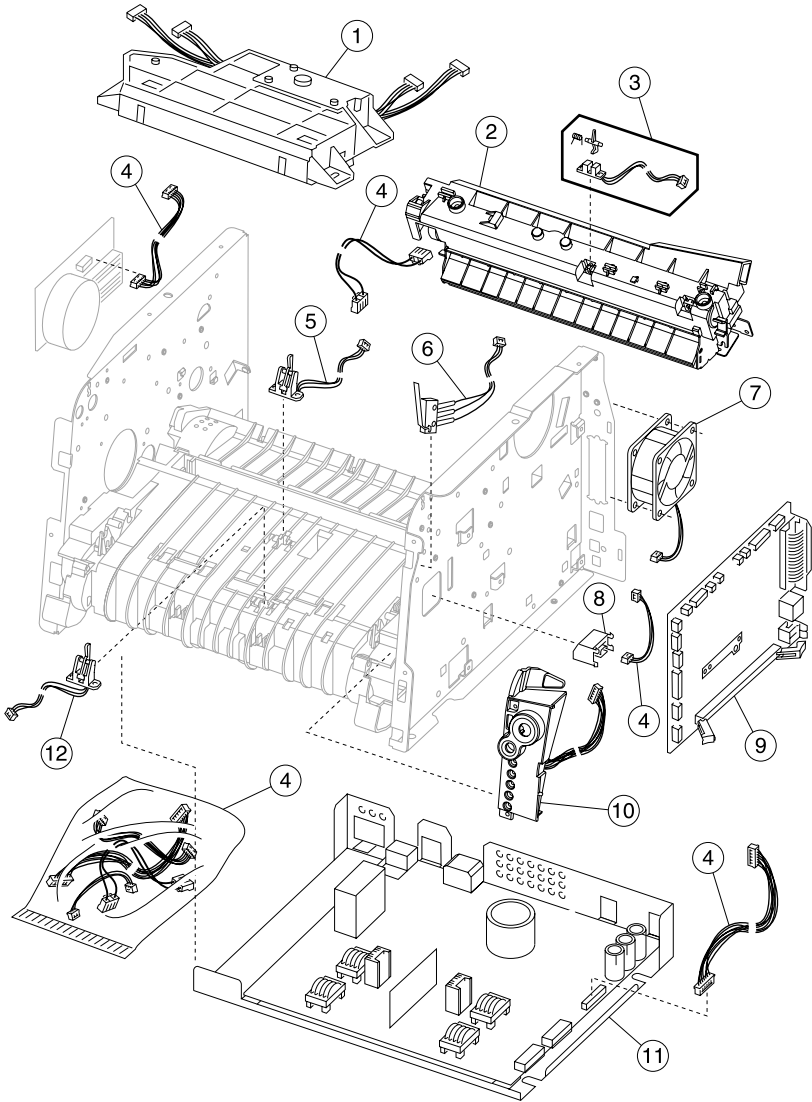







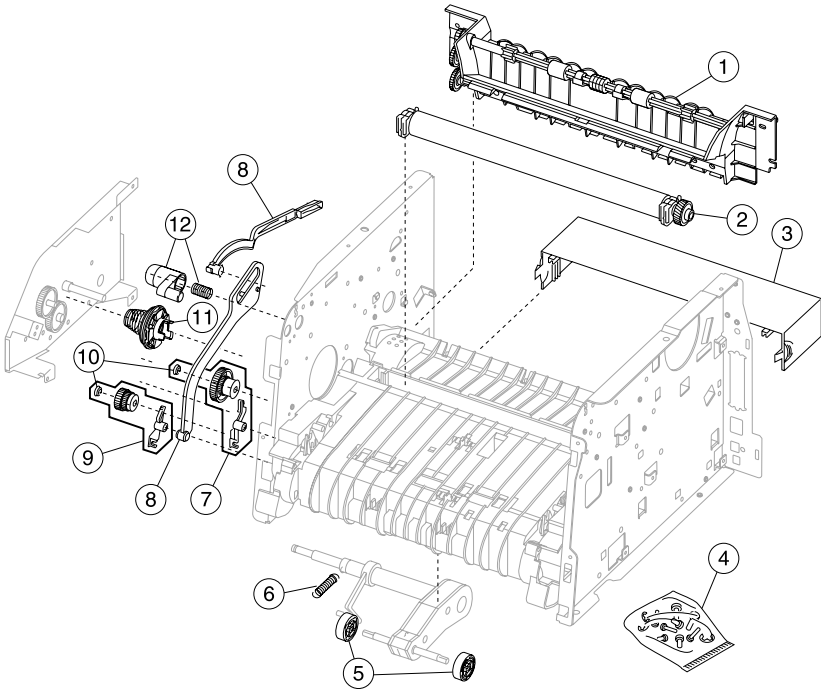

Assembly 2: Electronics

Index	P/N	Units	Description
2-1	56P1812	1	Print assembly, laser/mirror E232
1	56P1829	1	Print assembly, laser/mirror E330/E332n/E234/E234n
1	56P1830	1	Print assembly, laser/mirror E230
2	56P1810	1	Fuser assembly, 110 V
2	56P1811	1	Fuser assembly, 220 V
2	56P2070	1	Fuser assembly, 100 V
3	56P1826	1	Sensor, exit
4	56P2077	1	Cable assemblies, miscellaneous <ul style="list-style-type: none"> • Toner sensor • LVPS/HVPS to controller • Main drive motor (E23x/E330) • Main drive motor (E234n/E332n) • Fuser power
5	56P1824	1	Sensor, input #1
6	56P1827	1	Sensor, cover open
7	56P2072	1	Fan, cooling
8	56P2076	1	Sensor, toner level
9	56P3087	1	Card, controller E232
9	56P3088	1	Card, controller E330, E234
9	56P3089	1	Card, controller E332n, E234n
9	56P3086	1	Card, controller E230
10	56P1817	1	Operator panel assembly, operator panel with PCB assembly
10	56P2092	1	Operator panel assembly, operator panel with PCB assembly (white)
11	56P1818	1	Card assembly, LVPS/HVPS 110 V
11	56P1819	1	Card assembly, LVPS/HVPS 220 V
12	56P1825	1	Sensor, input #2 (manual)

Assembly 3: Frame



Assembly 3: Frame

Index	P/N	Units	Description
3-1	56P2078	1	Guide assembly, paper exit
2	56P1823	1	Transfer, roll, bearings, gear
3	56P1822	1	Cover, legal extender
3	56P2094	1	Cover, legal extender (white)
4	56P2646	N/A	Screws, miscellaneous (actual size)
			TP2NC-3.0+6P-Ni (quantity 2)
			 
			M3.0*0.5+6P-Ni,2 Washer (quantity 2)
			 
			MT3.0*0.5+6PF-Ni (quantity 5)
			 
			TP2NC-3.0+6PF-Ni (quantity 4)
			 
5	56P1820	2	Paper feed, rubber tires
6	56P2647	1	Springs, front door and ACM
7	56P2075	1	Clutch CBM, ACM
8	56P2083	1	Link CBM, door-fuser idle gear
9	56P2074	1	Clutch CBM, manual feed
10	56P2648	2	Rings, plastic snap
11	56P2073	1	Coupling assembly, developer drive
12	56P2082	1	Latch CBM, access cover

Assembly 4: Miscellaneous

This page intentionally left blank.

Assembly 4: Miscellaneous

Index	P/N	Units	Description
NS	56P1232	1	Adapter, US 802.11B wireless print
NS	56P1233	1	Adapter, INTL 802.11B wireless print
NS	56P1431	1	Adapter, MarkNet X2011E external
NS	56P1432	1	Adapter, MarkNet X2012E external
NS	56P1433	1	Adapter, MarkNet X2031E external
NS	56P1434	1	Adapter, MarkNet X2030 Token Ring external
NS	56P1435	1	Adapter, external serial
NS	1038693	1	Cable, serial, 50 foot (PSO)
NS	12A2405	1	Cable, packaged USB
NS	1329605	1	Cable, packaged parallel
NS	1427498	1	Cable, 20 foot parallel cable, with pack
NS	56P1417	1	Card assembly, 16MB flash
NS	56P1418	1	Card assembly, 32MB flash
NS	56P1427	1	Card assembly, OptraForms 32MB flash
NS	56P1428	1	Card assembly, OptraForms 16MB flash
NS	56P1429	1	Card assembly, simplified Chinese font
NS	56P1430	1	Card assembly, traditional Chinese font
NS	56P2231	1	Card assembly, Korean font
NS	56P0696	1	DIMM, 16MB PC100 SDR DIMM
NS	56P0697	1	DIMM, 32MB PC100 SDR DIMM
NS	56P0698	1	DIMM, 64MB PC100 SDR DIMM
NS	56P0699	1	DIMM, 128MB PC100 SDR DIMM
NS	7372839	1	Package assembly, field relocation
NS	1339520	1	Power cord, Spain, 8 foot (straight)
NS	11D0330	1	Power cord, Argentina
NS	1339528	1	Power cord, United Kingdom, 6 foot
NS	1339529	1	Power cord, Austria HV, 6 foot (straight)
NS	1339530	1	Power cord, Israel, 6 foot (straight)
NS	1339531	1	Power cord, Switzerland, 6 foot
NS	1339532	1	Power cord, South Africa, 6 foot
NS	1339533	1	Power cord, Italy, 6 foot (straight)
NS	1339534	1	Power cord, Danish, 6 foot (straight)
NS	1339548	1	Power cord, Brazil, 6 foot (straight)
NS	43H5545	1	Power cord, PRC, 1.77M (straight)
NS	56P9926	1	Software, Optra Forms
NS	56P9927	1	Software, Optra Forms director

Index

A

- abbreviations 1-8
- auto CR after LF (setup menu) 3-7
- auto LF after CR (setup menu) 3-7

B

- buttons 1-3

C

- configuration menu 3-1
 - moving around the menu 3-3
 - printer diagnostics 3-5
 - printer setting configuration 3-4
- configuration menu selections
 - network 3-10
 - parallel 3-8
 - setup 3-7
 - USB 3-9
 - utilities 3-6
- configuration menus
 - parallel
 - MAC binary PS 3-8, 3-10
 - mode 2 3-8
 - NPA mode 3-8, 3-10, 3-11
 - protocol 3-8
 - setup
 - auto CR after LF 3-7
 - auto LF after CR 3-7
 - USB
 - MAC binary PS 3-9
 - NPA mode 3-9
 - utilities
 - Hex Trace 3-6
 - print quality test pages 3-6
 - reset factory defaults 3-6

D

- diagnostic aids
 - accessing configuration group 3-2
 - accessing diagnostic group 3-2
 - configuration menu 3-1
 - diagnostic menu 3-1
 - power-on operations 3-2
- diagnostic menu 3-1
 - moving around the menu 3-3
 - printer diagnostics 3-5
 - printer setting configuration 3-4
- diagnostic menu selections
 - development 3-12
 - network 3-13
 - parallel 3-13

E

- error light 2-16, 2-18

G

- general information 1-1

H

- Hex Trace (utilities menu) 3-6

L

- laser notices vii
- lights 1-3, 2-3
- load paper light
 - Tray 1 or 550-sheet tray 2-12
- locations 5-1
 - controller board 5-3
 - front and rear views 5-1
 - power supply board 5-2
 - wiring diagram 5-4

M

MAC binary PS

parallel menu 3-8, 3-10

USB menu 3-9

mode 2 (parallel menu) 3-8

models 1-1

differences 1-2

E230 1-1

E232 1-1

E234 1-1

E234n 1-1

E330 1-1

E332n 1-1

N

NPA mode

parallel menu 3-8, 3-10, 3-11

USB menu 3-9

O

operator panel

buttons 1-3

common light sequences 2-3

light sequences

canceling job 2-17

change invalid toner cartridge
2-16

Hex Trace ready 2-10

Invalid network code 2-16

Load Tray 1 or 550-sheet tray
2-12

not ready 2-11

offline 2-11

printing a directory 2-9

printing a font list 2-9

printing menu settings pages
2-9printing print quality test pages
2-9programming engine code
2-17

programming flash 2-9

programming system code
2-17

resetting printer 2-17

restoring factory defaults
2-17

lights 1-3, 2-3

overview 2-2

primary codes

busy 2-9

cancel job / reset printer 2-17

change invalid toner cartridge
2-16close door / insert cartridge
2-12flushing/resolution reduced
2-11

hex trace ready 2-10

invalid engine code 2-16

invalid network code 2-16

load manual feeder 2-13

load media 2-12

not ready 2-11

print side two of duplex job
2-13

printer error 2-18

programming engine code
2-17programming system code
2-17

ready/power saver 2-8

replace photoconductor kit
2-14

service error 2-18

toner cartridge error 2-15

toner cartridge not installed
2-15

toner low 2-14

waiting 2-10

secondary codes
 2-19
 complex page 2-21
 defective flash 2-23
 error communicating with
 host 2-25
 flash full 2-26
 font error 2-23
 insufficient collation area
 2-22
 insufficient defrag memory
 2-24
 insufficient printer memory
 2-22
 invalid engine code 2-27
 invalid network code 2-28
 memory full 2-25
 network interface errors
 2-24
 paper jams as it exits tray
 2-20
 paper jams as printed job ex-
 its 2-21
 short paper 2-26
 unformatted flash 2-27
 secondary errors 2-6
 service check 2-59
 understanding lights 2-3
 overview
 operator panel 1-3

P

paper jams
 clearing 1-4
 tips on preventing 1-5
 part number index i-5
 parts catalog
 covers 7-2
 electronics 7-4
 frame 7-6
 how to use 7-1
 POST 2-1
 POST symptoms 2-44
 power-on self test (POST) 2-1
 preventive maintenance 6-1

print media
 manual feed 1-7
 Tray 1 1-7
 Tray 2 1-7
 types 1-7
 print quality problems
 solving 2-73
 print quality test pages
 using 2-66
 print quality test pages (utilities menu)
 3-6
 printer symptom table 2-45
 protocol (parallel menu) 3-8

R

removals 4-1
 controller card 4-4
 cover open sensor 4-5
 covers 4-2
 access 4-2
 access cover logo 4-4
 extender 4-2
 left side 4-3
 rear 4-3
 right side 4-3
 top 4-4
 developer drive coupling asm. 4-5
 door latch asm. 4-5
 exit sensor 4-6
 fan 4-6
 feed rollers 4-7
 fuser 4-8
 fuser idle gear links 4-7
 fuser power cable 4-8
 input roller clutch and lever 4-9
 input sensor #1 4-9
 input sensor #2 4-10
 LVPS/HVPS card asm. 4-10
 LVPS/HVPS to controller card cable
 4-11
 manual feed clutch asm. 4-11
 operator panel 4-11

paper exit guide asm. 4-12
 printhead 4-12
 toner level sensor 4-13
 toner level sensor cable 4-12
 reset factory defaults (utilities menu)
 3-6

S

safety information xv
 secondary error codes
 complex page 2-21
 defective flash 2-23
 error communicating with the host
 computer 2-25
 flash full 2-26
 font error 2-23
 insufficient collation area 2-22
 insufficient defrag memory 2-24
 insufficient printer memory 2-22
 invalid engine code 2-27
 invalid network code 2-28
 memory full 2-25
 network interface errors 2-24
 PPDS font error 2-23
 short paper 2-26
 unformatted flash 2-27
 service
 information 2-29
 secondary error codes 2-30
 secondary light patterns 2-29
 tertiary error codes 2-31
 controller software 2-32
 drive motor or transfer roll
 2-33
 engine communication 2-35
 fuser, fan or toner sensor
 2-34
 network error 2-42
 paper port communication
 failure 2-43
 printhead, transport motor or
 RIP 2-35
 RAM memory error 2-41

service checks 2-47
 controller card 2-49
 cooling fan 2-48
 cover interlock 2-51
 dead machine 2-52
 fuser 2-53
 cold 2-47
 hot 2-56
 LVPS/HVPS 2-57
 main motor 2-58
 operator panel 2-59
 operator panel button 2-59
 paper feed 2-61
 paper jam during POST 2-61
 paper never picks 2-63
 paper picks but stops 2-62
 paper picks during POST
 2-62
 paper picks sheets 2-64
 paper trees, curls 2-65
 parallel port 2-65
 print quality 2-66
 black page 2-68
 blank page 2-67
 heavy background 2-69
 image density 2-70
 light print 2-71
 partial blank image 2-70
 poor fusing of image 2-71
 toner on back of page 2-72
 white or black lines 2-72
 transfer roll 2-79
 service error lights 2-18
 symptom tables 2-44
 POST 2-44
 printer 2-45

T

tools 1-6

Part number index

P/N	Description	Page
1038693	Cable, serial, 50 foot (PSO)	7-9
11D0330	Power cord, Argentina	7-9
12A2405	Cable, packaged USB	7-9
1329605	Cable, packaged parallel	7-9
1339520	Power cord, Spain, 8 foot (straight)	7-9
1339528	Power cord, United Kingdom, 6 foot	7-9
1339529	Power cord, Austria HV, 6 foot (straight)	7-9
1339530	Power cord, Israel, 6 foot (straight)	7-9
1339531	Power cord, Switzerland, 6 foot	7-9
1339532	Power cord, South Africa, 6 foot	7-9
1339533	Power cord, Italy, 6 foot (straight)	7-9
1339534	Power cord, Danish, 6 foot (straight)	7-9
1339548	Power cord, Brazil, 6 foot (straight)	7-9
1427498	Cable, 20 foot parallel cable, with pack	7-9
43H5545	Power cord, PRC, 1.77M (straight)	7-9
56P0696	DIMM, 16MB PC100 SDR DIMM	7-9
56P0697	DIMM, 32MB PC100 SDR DIMM	7-9
56P0698	DIMM, 64MB PC100 SDR DIMM	7-9
56P0699	DIMM, 128MB PC100 SDR DIMM	7-9
56P1232	Adapter, US 802.11B wireless print	7-9
56P1233	Adapter, INTL 802.11B wireless print	7-9
56P1417	Card assembly, 16MB flash	7-9
56P1418	Card assembly, 32MB flash	7-9
56P1427	Card assembly, OptraForms 32MB flash	7-9
56P1428	Card assembly, OptraForms 16MB flash	7-9
56P1429	Card assembly, simplified Chinese font	7-9
56P1430	Card assembly, traditional Chinese font	7-9
56P1431	Adapter, MarkNet X2011E external	7-9
56P1432	Adapter, MarkNet X2012E external	7-9
56P1433	Adapter, MarkNet X2031E external	7-9
56P1434	Adapter, MarkNet X2030 Token Ring external	7-9
56P1435	Adapter, external serial	7-9
56P1810	Fuser assembly, 110 V	7-5
56P1811	Fuser assembly, 220 V	7-5

56P1812	Print assembly, laser/mirror E232	7-5
56P1816	Cover assembly, front access (no logo)	7-3
56P1817	Operator panel assembly, operator panel with PCB assembly	7-5
56P1818	Card assembly, LVPS/HVPS 110 V	7-5
56P1819	Card assembly, LVPS/HVPS 220 V	7-5
56P1820	Paper feed, rubber tires	7-7
56P1821	Cover, right	7-3
56P1822	Cover, legal extender	7-7
56P1823	Transfer, roll, bearings, gear	7-7
56P1824	Sensor, input #1	7-5
56P1825	Sensor, input #2 (manual)	7-5
56P1826	Sensor, exit	7-5
56P1827	Sensor, cover open	7-5
56P1829	Print assembly, laser/mirror E330 / E332n	7-5
56P1830	Print assembly, laser/mirror E230	7-5
56P1832	Cover, logo plate E332n	7-3
56P1833	Cover, logo plate E230	7-3
56P1834	Tray, main (white)	7-3
56P2070	Fuser assembly, 100 V	7-5
56P2072	Fan, cooling	7-5
56P2073	Coupling assembly, developer drive	7-7
56P2074	Clutch CBM, manual feed	7-7
56P2075	Clutch CBM, ACM	7-7
56P2076	Sensor, toner level	7-5
56P2077	Cable assemblies, miscellaneous	7-5
56P2077	Cable assembly, misc.- fuser power	7-5
56P2077	Cable assembly, misc.- LVPS/HVPS to controller	7-5
56P2077	Cable assembly, misc.- main drive motor	7-5
56P2077	Cable assembly, misc.- toner sensor	7-5
56P2077	Fuser power	7-5
56P2078	Guide assembly, paper exit	7-7
56P2079	Cover assembly, top	7-3
56P2080	Cover, left	7-3
56P2081	Cover, logo plate E330	7-3
56P2082	Latch CBM, access cover	7-7
56P2083	Link CBM, door-fuser idle gear	7-7
56P2084	Tray 2, optional (white)	7-3
56P2085	Cover, logo plate E232	7-3
56P2086	Cover, logo plate (plain)	7-3
56P2087	Cover assembly, rear	7-3
56P2088	Tray, main	7-3
56P2089	Drawer, optional	7-3
56P2090	Tray 2, optional	7-3
56P2091	Cover assembly, front access (white)	7-3
56P2092	Operator panel assembly, operator panel with PCB assembly	7-5
(white)		7-5

56P2093	Cover, right (white)	7-3
56P2094	Cover, legal extender (white)	7-7
56P2095	Cover, left (white)	7-3
56P2096	Cover, logo plate (white) E330	7-3
56P2097	Cover, logo plate (white) E232	7-3
56P2098	Cover assembly, rear (white)	7-3
56P2231	Card assembly, Korean font	7-9
56P2628	Cover, logo plate (white) E230	7-3
56P2629	Cover, logo plate (white) E332	7-3
56P2646	Screws, miscellaneous	7-7
56P2647	Springs, front door and ACM	7-3, 7-7
56P2648	Rings, plastic snap	7-7
56P2703	Cover, logo plate E234	7-3
56P3086	Card, controller E230	7-5
56P3087	Card, controller E232	7-5
56P3088	Card, controller E330, E234	7-5
56P3089	Card, controller E332n, E234n	7-5
56P9926	Software, Optra Forms	7-9
56P9927	Software, Optra Forms director	7-9
7372839	Package assembly, field relocation	7-9

