



Service Manual

Lexmark™ E220
Lexmark™ E32x

4500–00x

4500–1xx

4500–2xx

- ***Table of Contents***
- ***Start Diagnostics***
- ***Safety and Notices***
- ***Trademarks***
- ***Index***

LEXMARK™

Lexmark and Lexmark with diamond design are trademarks of Lexmark International, Inc., registered in the United States and/or other countries.

Edition: May 2004

The following paragraph does not apply to any country where such provisions are inconsistent with local law: LEXMARK INTERNATIONAL, INC. PROVIDES THIS PUBLICATION "AS IS" WITHOUT WARRANTY OF ANY KIND, EITHER EXPRESS OR IMPLIED, INCLUDING, BUT NOT LIMITED TO, THE IMPLIED WARRANTIES OF MERCHANTABILITY OR FITNESS FOR A PARTICULAR PURPOSE. Some states do not allow disclaimer of express or implied warranties in certain transactions; therefore, this statement may not apply to you.

This publication could include technical inaccuracies or typographical errors. Changes are periodically made to the information herein; these changes will be incorporated in later editions. Improvements or changes in the products or the programs described may be made at any time.

Comments may be addressed to Lexmark International, Inc., Department D22A/032-2, 740 West New Circle Road, Lexington, Kentucky 40550, U.S.A or e-mail at ServiceInfoAndTraining@Lexmark.com. Lexmark may use or distribute any of the information you supply in any way it believes appropriate without incurring any obligation to you. You can purchase additional copies of publications related to this product by calling 1-800-553-9727. In other countries, contact your point of purchase.

Lexmark, Lexmark with diamond design, MarkNet, and MarkVision are trademarks of Lexmark International, Inc., registered in the United States and/or other countries.

Opra Forms is a trademark of Lexmark International, Inc.

PCL® is a registered trademark of the Hewlett-Packard Company.

PostScript® is a registered trademark of Adobe Systems Incorporated.

Other trademarks are the property of their respective owners.

© 2001, 2004 Copyright Lexmark International, Inc.

All rights reserved.

UNITED STATES GOVERNMENT RIGHTS

This software and any accompanying documentation provided under this agreement are commercial computer software and documentation developed exclusively at private expense.

Table of contents

Laser notices	vii
Safety information	xvii
Preface	xxii
General information	1-1
Model differences	1-4
Printer operation	1-5
Printer dimensions and clearance	1-5
Options	1-6
Acronyms	1-7
Diagnostic information	2-1
Start	2-1
Diagnostics (E320/E322)	2-1
Operator panel	2-2
Status information	2-3
Attendance information	2-4
Service information	2-7
Service error codes	2-11
Operator panel light summary table	2-25
Error code table	2-26
Power-On Self Test (POST)	2-32
Symptom tables	2-32
Diagnostics (E220/E321/E323)	2-35
Operator panel	2-36
Light patterns	2-37
Status information light patterns	2-38
Obtaining information about printer service error codes	2-44
Service error codes	2-45
Power-on operations	2-59
Power-On Self Test (POST)	2-60
Symptom tables	2-60

Service checks	2-63
Cold fuser service check	2-64
Cooling fan service check (E320/E322)	2-65
Cooling fan service check (E220/E321/E323)	2-66
Controller card service check (E220/E321/E323)	2-67
Cover interlock switch service check (E320/E322)	2-69
Cover interlock switch service check (E220/E321/E323)	2-70
Dead machine service check	2-71
Engine board service check (E320/E322)	2-72
Fuser service check	2-74
Hot fuser service check	2-76
Low voltage power supply (LVPS) service check	2-76
Main motor service check	2-77
Operator panel button service check	2-78
Operator panel service check	2-79
Paper feed service checks	2-81
Parallel port service check	2-85
Print quality service checks	2-86
Transfer roll service check	2-99
Resetting user defaults (E320/E322)	2-100
Restoring factory defaults (E320/E322)	2-101
Restoring factory defaults (E220/E321/E323)	2-101
Using Hex Trace mode (E320/E322)	2-102
Using Hex Trace mode (E220/E321/E323)	2-102
Using print quality test pages (E320/E322)	2-103
Using print quality test pages (E220/E321/E323)	2-104
Using the special function menu (E320/E322)	2-105
Using the special function menu (E220/E321/E323)	2-106
Diagnostic aids	3-1
Diagnostic aids (320/E322)	3-1
Performing self test	3-1
Information priority	3-1
Printer operation modes	3-2
Printer modes summary table	3-3
Normal printing mode	3-6
Demo printing mode	3-7
Printing menu settings page	3-8
Diagnostic tests mode	3-9
Special function menu	3-11
Configuration mode	3-14

Diagnostic aids	3-35
Diagnostic aids (E220/E321/E323)	3-35
Operator panel	3-35
Configuration menu group or diagnostic menu group	3-36
Printer diagnostics mode	3-40
Repair information	4-1
Handling electrostatic discharge (ESD)-sensitive parts	4-1
Adjustment	4-2
Printhead assembly	4-2
Lubrication	4-3
Removal procedures	4-4
Cover removals	4-4
Auto sheet feed (ASF) assembly removal	4-5
Charge roll assembly removal	4-6
Controller card cage removal	4-7
Controller card removal	4-7
Cooling fan removal	4-8
D-roll removal	4-9
Engine board removal (E320/E322 only)	4-9
Fuser assembly removal	4-10
High voltage power supply (HVPS) removal	4-10
Low voltage power supply (LVPS) removal	4-11
Operator panel removal	4-11
Paper feed clutch solenoid removal	4-12
Printhead assembly removal	4-13
Transfer roll removal	4-13
Connector locations	5-1
LVPS—low voltage power supply board	5-1
HVPS—high voltage power supply board	5-2
Engine board (E320/E322 only)	5-2
RIP controller (E320/E322 only)	5-6
Controller (E220/E321/E323 only)	5-7
RIP controller (E220/E321/E323 only)	5-8
Option card (replaceable on E320/E322 only)	5-11
E220/E321/E323 wiring diagram	5-12
Preventive maintenance	6-1

Parts catalog7-1

- How to use this parts catalog7-1
- Assembly 1: Covers (E320/E322)7-2
- Assembly 2: Frame7-8
- Assembly 3: Fuser7-10
- Assembly 4: Main drive7-12
- Assembly 5: Paper feed7-14
- Assembly 6: Printhead7-16
- Assembly 7: Electronics7-18
- Assembly 8: Options7-22
- Assembly 9: Cables.....7-26
- Assembly 10: Miscellaneous7-27

Index I-7

Part number index I-1

Laser notices

The following laser notice labels may be affixed to this printer as shown:

Laser advisory label



5mW
780nm-800nm

DANGER	— INVISIBLE LASER RADIATION WHEN OPEN. AVOID DIRECT EXPOSURE TO BEAM.
VORSICHT	— UNSICHTBARE LASERSTRAHLUNG. WENN ABDECKUNG GEÖFFNET UND SICHERHEITSVERRIEGELUNG ÜBERBRÜCKT, NICHT DEM STRAHL AUSSETZEN.
DANGER	— RAYON LASER INVISIBLE LORS DE LOUVER TURE. EVITER L'EXPOSITION DIRECTE.
PELIGRO	— RADIACION LASER INVISIBLE AL ABRIR. EVITAR LA EXPOSICION DIRECTA AL HAZ.
危険	— 開けたときレーザー放射の危険有り。 ビームに直接当たらないように注意して下さい。 MAS

Class 1 laser statement label

LEXMARK
TM

Machine Type: 4500-003
Serial No.: 6000028
Manufactured: June 2001

Program © Copyright Lexmark International, Inc.
All Rights Reserved 2001
Canada ICES-003, Class B
Canada NMB-003, Classe B



Manufactured for Lexmark International, Inc.
Lexington, Kentucky, USA
Made in Korea

110-127V 50/60Hz 8.2A Max
375 W. Print 11W Power Saver



Tested to Comply With FCC
Standards
FOR HOME OR OFFICE USE

Class 1 Laser Product
This Laser Product conforms to the applicable
requirements of 21 CFR, Chapter I, Subchapter J.

TLI: 08A0300

S/N: 6000028



Config: 102104

CLASS 1 LASER PRODUCT
LASER KLASSE 1
LUOKAN 1 LASERLAITE
APPAREIL À LASER DE CLASSE 1
TO IEC 60825

Laser notice

The printer is certified in the U.S. to conform to the requirements of DHHS 21 CFR Subchapter J for Class I (1) laser products, and elsewhere is certified as a Class I laser product conforming to the requirements of IEC 60825-1.

Class I laser products are not considered to be hazardous. The printer contains internally a Class IIIb (3b) laser that is nominally a 5 milliwatt gallium arsenide laser operating in the wavelength region of 770-795 nanometers. The laser system and printer are designed so there is never any human access to laser radiation above a Class I level during normal operation, user maintenance, or prescribed service condition.

Laser

Der Drucker erfüllt gemäß amtlicher Bestätigung der USA die Anforderungen der Bestimmung DHHS (Department of Health and Human Services) 21 CFR Teil J für Laserprodukte der Klasse I (1). In anderen Ländern gilt der Drucker als Laserprodukt der Klasse I, der die Anforderungen der IEC (International Electrotechnical Commission) 60825-1 gemäß amtlicher Bestätigung erfüllt.

Laserprodukte der Klasse I gelten als unschädlich. Im Inneren des Druckers befindet sich ein Laser der Klasse IIIb (3b), bei dem es sich um einen Galliumarsenlaser mit 5 Milliwatt handelt, der Wellen der Länge 770-795 Nanometer ausstrahlt. Das Lasersystem und der Drucker sind so konzipiert, daß im Normalbetrieb, bei der Wartung durch den Benutzer oder bei ordnungsgemäßer Wartung durch den Kundendienst Laserbestrahlung, die die Klasse I übersteigen würde, Menschen keinesfalls erreicht.

Avis relatif à l'utilisation de laser

Pour les Etats-Unis : cette imprimante est certifiée conforme aux provisions DHHS 21 CFR alinéa J concernant les produits laser de Classe I (1). Pour les autres pays : cette imprimante répond aux normes IEC 60825-1 relatives aux produits laser de Classe I.

Les produits laser de Classe I sont considérés comme des produits non dangereux. Cette imprimante est équipée d'un laser de Classe IIIb (3b) (arséniure de gallium d'une puissance nominale de 5 milliwatts) émettant sur des longueurs d'onde comprises entre 770 et 795 nanomètres. L'imprimante et son système laser sont conçus pour impossible, dans des conditions normales d'utilisation, d'entretien par l'utilisateur ou de révision, l'exposition à des rayonnements laser supérieurs à des rayonnements de Classe I.

Avvertenze sui prodotti laser

Questa stampante è certificata negli Stati Uniti per essere conforme ai requisiti del DHHS 21 CFR Sottocapitolo J per i prodotti laser di classe 1 ed è certificata negli altri Paesi come prodotto laser di classe 1 conforme ai requisiti della norma CEI 60825-1.

I prodotti laser di classe non sono considerati pericolosi. La stampante contiene al suo interno un laser di classe IIIb (3b) all'arseniuro di gallio della potenza di 5mW che opera sulla lunghezza d'onda compresa tra 770 e 795 nanometri. Il sistema laser e la stampante sono stati progettati in modo tale che le persone a contatto con la stampante, durante il normale funzionamento, le operazioni di servizio o quelle di assistenza tecnica, non ricevano radiazioni laser superiori al livello della classe 1.

Avisos sobre el láser

Se certifica que, en los EE.UU., esta impresora cumple los requisitos para los productos láser de Clase I (1) establecidos en el subcapítulo J de la norma CFR 21 del DHHS (Departamento de Sanidad y Servicios) y, en los demás países, reúne todas las condiciones expuestas en la norma IEC 60825-1 para productos láser de Clase I (1).

Los productos láser de Clase I no se consideran peligrosos. La impresora contiene en su interior un láser de Clase IIIb (3b) de arseniuro de galio de funcionamiento nominal a 5 milivatios en una longitud de onda de 770 a 795 nanómetros. El sistema láser y la impresora están diseñados de forma que ninguna persona pueda verse afectada por ningún tipo de radiación láser superior al nivel de la Clase I durante su uso normal, el mantenimiento realizado por el usuario o cualquier otra situación de servicio técnico.

Declaração sobre Laser

A impressora está certificada nos E.U.A. em conformidade com os requisitos da regulamentação DHHS 21 CFR Subcapítulo J para a Classe I (1) de produtos laser. Em outros locais, está certificada como um produto laser da Classe I, em conformidade com os requisitos da norma IEC 60825-1.

Os produtos laser da Classe I não são considerados perigosos. Internamente, a impressora contém um produto laser da Classe IIIb (3b), designado laser de arseneto de potássio, de 5 milliwatts, operando numa faixa de comprimento de onda entre 770 e 795 nanómetros. O sistema e a impressora laser foram concebidos de forma a nunca existir qualquer possibilidade de acesso humano a radiação laser superior a um nível de Classe I durante a operação normal, a manutenção feita pelo utilizador ou condições de assistência prescritas.

Laserinformatie

De printer voldoet aan de eisen die gesteld worden aan een laserprodukt van klasse I. Voor de Verenigde Staten zijn deze eisen vastgelegd in DHHS 21 CFR Subchapter J, voor andere landen in IEC 60825-1.

Laserprodukten van klasse I worden niet als ongevaarlijk aangemerkt. De printer is voorzien van een laser van klasse IIIb (3b), dat wil zeggen een gallium arsenide-laser van 5 milliwatt met een golflengte van 770-795 nanometer. Het lasergedeelte en de printer zijn zo ontworpen dat bij normaal gebruik, bij onderhoud of reparatie conform de voorschriften, nooit blootstelling mogelijk is aan laserstraling boven een niveau zoals voorgeschreven is voor klasse 1.

Lasermeddelelse

Printeren er godkendt som et Klasse I-laserprodukt, i overensstemmelse med kravene i IEC 60825-1.

Klasse I-laserprodukter betragtes ikke som farlige. Printeren indeholder internt en Klasse IIIB (3b)-laser, der nominelt er en 5 milliwatt galliumarsenid laser, som arbejder på bølgelængdeområdet 770-795 nanometer. Lasersystemet og printeren er udformet således, at mennesker aldrig udsættes for en laserstråling over Klasse I-niveau ved normal drift, brugervedligeholdelse eller obligatoriske servicebetingelser.

Huomautus laserlaitteesta

Tämä kirjoitin on Yhdysvalloissa luokan I (1) laserlaitteiden DHHS 21 CFR Subchapter J -määrityksen mukainen ja muualla luokan I laserlaitteiden IEC 60825-1 -määrityksen mukainen.

Luokan I laserlaitteiden ei katsota olevan vaarallisia käyttäjälle. Kirjoittimessa on sisäinen luokan IIIb (3b) 5 milliwatin galliumarsenidilaser, joka toimii aaltoalueella 770 - 795 nanometriä. Laserjärjestelmä ja kirjoitin on suunniteltu siten, että käyttäjä ei altistu luokan I määräyksiä voimakkaammalle säteilylle kirjoittimen normaalin toiminnan, käyttäjän tekemien huoltotoimien tai muiden huoltotoimien yhteydessä.

VARO! Avattaessa ja suojalukitus ohitettaessa olet alttiina näkymättömälle lasersäteilylle. Älä katso säteeseen.

WARNING! Osynlig laserstrålning när denna del är öppnad och spårren är urkopplad. Betrakta ej strålen.

Laser-notis

Denna skrivare är i USA certifierad att motsvara kraven i DHHS 21 CFR, underparagraf J för laserprodukter av Klass I (1). I andra länder uppfyller skrivaren kraven för laserprodukter av Klass I enligt kraven i IEC 60825-1.

Laserprodukter i Klass I anses ej hälsovådliga. Skrivaren har en inbyggd laser av Klass IIIb (3b) som består av en laserenhet av gallium-arsenid på 5 milliwatt som arbetar i våglängdsområdet 770-795 nanometer. Lasersystemet och skrivaren är utformade så att det aldrig finns risk för att någon person utsätts för laserstrålning över Klass I-nivå vid normal användning, underhåll som utförs av användaren eller annan föreskriven serviceåtgärd.

Laser-melding

Skriveren er godkjent i USA etter kravene i DHHS 21 CFR, underkapittel J, for klasse I (1) laserprodukter, og er i andre land godkjent som et Klasse I-laserprodukt i samsvar med kravene i IEC 60825-1.

Klasse I-laserprodukter er ikke å betrakte som farlige. Skriveren inneholder internt en klasse IIIb (3b)-laser, som består av en gallium-arsenlaserenhet som avgir stråling i bølgelengdeområdet 770-795 nanometer. Lasersystemet og skriveren er utformet slik at personer aldri utsettes for laserstråling ut over klasse I-nivå under vanlig bruk, vedlikehold som utføres av brukeren, eller foreskrevne serviceoperasjoner.

Avís sobre el Làser

Segons ha estat certificat als Estats Units, aquesta impressora compleix els requisits de DHHS 21 CFR, apartat J, pels productes làser de classe I (1), i segons ha estat certificat en altres llocs, és un producte làser de classe I que compleix els requisits d'IEC 60825-1.

Els productes làser de classe I no es consideren perillosos. Aquesta impressora conté un làser de classe IIIb (3b) d'arseniür de gal.li, nominalment de 5 mil.liwats, i funciona a la regió de longitud d'ona de 770-795 nanòmetres. El sistema làser i la impressora han sigut concebuts de manera que mai hi hagi exposició a la radiació làser per sobre d'un nivell de classe I durant una operació normal, durant les tasques de manteniment d'usuari ni durant els serveis que satisfacin les condicions prescrites.

Japanese laser notice

レーザーに関するお知らせ

このプリンターは、米国ではDHHS 21 CFRサブチャプターJのクラスI (1)の基準を満たしたレーザー製品であることが証明されています。また米国以外ではIEC 825の基準を満たしたクラスIのレーザー製品であることが証明されています。

クラスIのレーザー製品には危険性はないと考えられています。このプリンターはクラスIII b (3 b)のレーザーを内蔵しています。このレーザーは、波長が770 ~ 795ナノメートルの範囲で、通常5ミリワットのガリウム砒化物を放射するレーザーです。このレーザーシステムとプリンターは、通常の操作、ユーザのメンテナンス、規定された修理においては、人体がクラスIのレベル以上のレーザー放射に晒されることのないよう設計されています。

Chinese laser notice

注意：

本打印机被美国认证合乎 DHHS 21 CFR Subchapter I 对分类 I (1) 激光产品的标准，而在其他地区则被认证合乎 IEC 825 的标准。

分类 I 激光产品一般认为不具危险性，本打印机内部含有分类 IIIb (3b) 的激光，在操作过程中会产生 5 毫瓦含镓及砷的微量激光，其波长范围在 770-795 nm 之间。本激光系统及打印机的设计，在一般操作、使用者维护或规定内的维修情况下，不会使人体接触分类 I 以上等级的辐射。

Korean laser notice

본프린터는 1등급 레이저 제품들에 대한 DHHS 21 CFR Subchapter 3의 규정을 준수하고 있음을 미국에서 인증받았으며, 그외의 나라에서도 IEC 825 규정을 준수하는 1등급 레이저 제품으로서 인증을 받았습니다.

1등급 레이저 제품들은 안전한 것으로 간주됩니다. 본 프린터는 5 밀리와트 갈륨 아르세나이드 레이저로서 770-795 나노미터의 파장대에서 활동하는 Class III (3b) 레이저를 내부에 갖고 있습니다. 본 레이저 시스템과 프린터는 정상 작동 중이나 유지 보수 중 또는 규정된 서비스 상태에서 상기의 Class I 수준의 레이저 방출에 사람이 절대 접근할 수 없도록 설계되어 있습니다.

Safety information

- The safety of this product is based on testing and approvals of the original design and specific components. The manufacturer is not responsible for safety in the event of use of unauthorized replacement parts.
- The maintenance information for this product has been prepared for use by a professional service person and is not intended to be used by others.
- There may be an increased risk of electric shock and personal injury during disassembly and servicing of this product. Professional service personnel should understand this and take necessary precautions.



CAUTION: When you see this symbol, there is a danger from hazardous voltage in the area of the product where you are working. Unplug the product before you begin, or use caution if the product must receive power in order to perform the task.

Consignes de Sécurité

- La sécurité de ce produit repose sur des tests et des agréments portant sur sa conception d'origine et sur des composants particuliers. Le fabricant n'assume aucune responsabilité concernant la sécurité en cas d'utilisation de pièces de rechange non agréées.
- Les consignes d'entretien et de réparation de ce produit s'adressent uniquement à un personnel de maintenance qualifié.
- Le démontage et l'entretien de ce produit pouvant présenter certains risques électriques, le personnel d'entretien qualifié devra prendre toutes les précautions nécessaires.

Norme di sicurezza

- La sicurezza del prodotto si basa sui test e sull'approvazione del progetto originale e dei componenti specifici. Il produttore non è responsabile per la sicurezza in caso di sostituzione non autorizzata delle parti.
- Le informazioni riguardanti la manutenzione di questo prodotto sono indirizzate soltanto al personale di assistenza autorizzato.
- Durante lo smontaggio e la manutenzione di questo prodotto, il rischio di subire scosse elettriche e danni alla persona è più elevato. Il personale di assistenza autorizzato, deve, quindi, adottare le precauzioni necessarie.

Sicherheitshinweise

- Die Sicherheit dieses Produkts basiert auf Tests und Zulassungen des ursprünglichen Modells und bestimmter Bauteile. Bei Verwendung nicht genehmigter Ersatzteile wird vom Hersteller keine Verantwortung oder Haftung für die Sicherheit übernommen.
- Die Wartungsinformationen für dieses Produkt sind ausschließlich für die Verwendung durch einen Wartungsfachmann bestimmt.
- Während des Auseinandernehmens und der Wartung des Geräts besteht ein zusätzliches Risiko eines elektrischen Schlags und körperlicher Verletzung. Das zuständige Fachpersonal sollte entsprechende Vorsichtsmaßnahmen treffen.

Pautas de Seguridad

- La seguridad de este producto se basa en pruebas y aprobaciones del diseño original y componentes específicos. El fabricante no es responsable de la seguridad en caso de uso de piezas de repuesto no autorizadas.
- La información sobre el mantenimiento de este producto está dirigida exclusivamente al personal cualificado de mantenimiento.
- Existe mayor riesgo de descarga eléctrica y de daños personales durante el desmontaje y la reparación de la máquina. El personal cualificado debe ser consciente de este peligro y tomar las precauciones necesarias.

Informações de Segurança

- A segurança deste produto baseia-se em testes e aprovações do modelo original e de componentes específicos. O fabricante não é responsável pela segurança, no caso de uso de peças de substituição não autorizadas.
- As informações de segurança relativas a este produto destinam-se a profissionais destes serviços e não devem ser utilizadas por outras pessoas.
- Risco de choques eléctricos e ferimentos graves durante a desmontagem e manutenção deste produto. Os profissionais destes serviços devem estar avisados deste facto e tomar os cuidados necessários.

Informació de Seguretat

- La seguretat d'aquest producte es basa en l'avaluació i aprovació del disseny original i els components específics. El fabricant no es fa responsable de les qüestions de seguretat si s'utilitzen peces de recanvi no autoritzades.
 - La informació pel manteniment d'aquest producte està orientada exclusivament a professionals i no està destinada a ningú que no ho sigui.
 - El risc de xoc elèctric i de danys personals pot augmentar durant el procés de desmuntatge i de servei d'aquest producte. El personal professional ha d'estar-ne assabentat i prendre les mesures convenients.
-

안전 사항

- 본 제품에 관한 유지 보수 설명서는 전문 서비스 기술자 용으로 작성된 것이므로 비 전문가는 사용할 수 없습니다.
- 본제품을 해체하거나 정비할 경우 전기적인 충격을 받거나 상처를 입을 위험이 커집니다. 전문 서비스 기술자는 이 사실을 숙지하고 필요한 예방 조치를 취하도록 하십시오.
- 일부 부품의 안전성은 항상 보장되지 않습니다. 따라서, 교체 부품은 원래 부품과 같거나 동등한 특성을 가진 제품을 사용하여야 합니다.

安全资讯

- 本产品的维护资讯仅供专业服务人员使用，而非针对一般使用者。
- 本产品在拆卸、维修的时候，遭受电击或人员受伤的危险性会增高，专业服务人员对这点必须有所了解，并采取必要的预防措施。
- 有些零件的安全功能可能不明显。因此，所替换零件的性能一定要与原有的零件一致。

Preface

This manual contains maintenance procedures for service personnel. It is divided into the following chapters:

1. **General Information** contains a general description of the printer and the maintenance approach used to repair it. Special tools and test equipment are listed in this chapter, as well as general environmental and safety instructions.
2. **Diagnostic Information** contains an error indicator table, symptom tables, and service checks used to isolate failing field replaceable units (FRUs).
3. **Diagnostic Aids** contains tests and checks used to locate or repeat symptoms of printer problems.
4. **Repair Information** provides instructions for making printer adjustments and removing and installing FRUs.
5. **Connector Locations** uses illustrations to identify the connector locations and test points on the printer.
6. **Preventive Maintenance** contains the lubrication specifications and recommendations to prevent problems.
7. **Parts Catalog** contains illustrations and part numbers for individual FRUs.

Definitions

Note: A note provides additional information.

Warning: A warning identifies something that might damage the printer hardware or software.

CAUTION: A caution identifies something that might cause a servicer harm.



CAUTION: When you see this symbol, there is a danger from hazardous voltage in the area of the product where you are working. Unplug the product before you begin, or use caution if the product must receive power in order to perform the task.

1. General information

The Lexmark™ E220/E32x series are letter-quality laser page monochrome desktop printers designed to fit into space critical environments and yet not sacrifice speed or ease of use. The E220/E32x attaches to an IBM Personal Computer or other computers compatible with the IBM Personal Computer (with 386 processor or higher) and Macintosh Computers via the Universal Serial Bus (USB) connection.

4500

Six printer models are available:

Models E320/E322

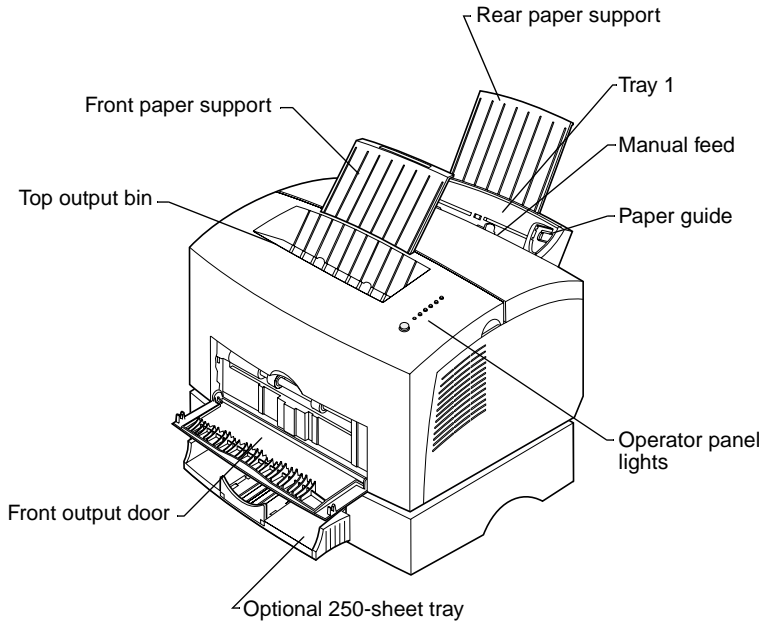

- Lexmark E320 printer with 4MB of standard memory
- Lexmark E322 printer with 8MB of standard memory
- Lexmark E322n printer with standard Ethernet and 16MB of standard memory

Models E220/E321/E323

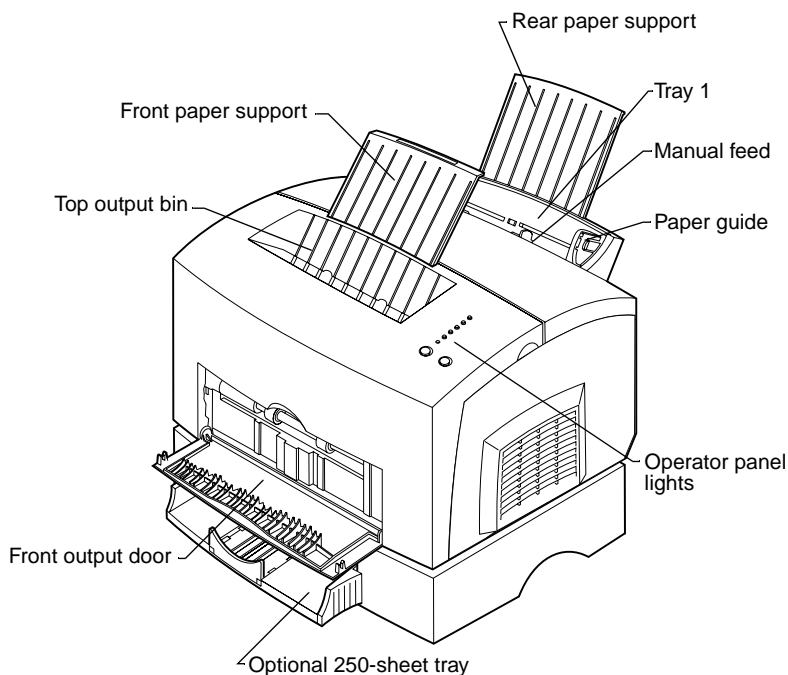

- Lexmark E220 printer with 8MB of standard memory
- Lexmark E321 printer with 8MB of standard memory
- Lexmark E323 printer with 16MB of standard memory
- Lexmark E323n printer with 16MB of standard memory and standard Ethernet

There are some apparent differences in the E320/E322 series and the E220/E321/E323 series. The E220/E321/E323 series has:

- a dark color in most geographies
- two buttons on the operator panel
- a bulge on the right side cover

Internally, the E220/E321/E323 series has:

- a combined engine and RIP card
- a different printhead and interlock switch
- a different fuser
- a different print cartridge
- Nonvolatile random access memory (NVRAM) located on the operator panel printed circuit board (PCB)
- higher speed pages per minute (ppm).

The E220 is similar to the E321 but has a slower speed.

Other differences are listed in the following table.

Model differences

	E220	E320	E321	E322	E322n	E323	E323n
MT/ model	4500– 101	4500– 001	4500– 201	4500– 002	4500– 003	4500– 202	4500– 213
Base memory	8MB	4MB	8MB	8MB	16MB	12MB	16MB
Compati- bility	MAC; OS support + HBP	MAC; OS support	MAC; OS support + HBP	MSQ; MAC; Linux; OS support / PS3	MSQ; MAC; Linux; OS support / PS3	MSQ; MAC; Linux; OS support /+HBP; PS3	MSQ; MAC; Linux; OS support /+HBP; PS3
PCL®	PCL 5e	PCL 5e	PCL 5e	PCL 6	PCL 6	PCL 6	PCL 6

Printer operation

Paper is held in a 150 page tray where it is picked by a center-fed D shape pick roller. The paper follows an L shape path as it moves through the printer. Images are created with toner on an optical photoconductor (OPC) drum within the toner cartridge. A transfer roller then draws the toner off the OPC drum onto the paper. Once the toner is affixed to the paper by the fuser, the paper exits either the top or front of the printer.

Printer dimensions and clearance

The following table contains the dimensions for each printer model. This does not include packaging but does include the print cartridge that ships with the printer.

Physical dimensions	E320/E322/E322n	E220/E321/ E323/E323n)
Height	221 mm (8.7 inches)	221 mm (8.7 inches)
Width	380 mm (15.0 inches)	391 mm (15.4 inches)
Depth	368 mm (14.5 inches)	368 mm (14.2 inches)

Operating clearance	
Top	203 mm (8 inches)
Left and right sides	305 mm (12 inches)
Front	152 mm (6 inches) None required except for paper ejection.
Rear	51 mm (2 inches)

Note: *Do not* enclose printer on all sides without providing ventilation.

Options

The following options are available for the Lexmark E220/E32x.

Note: Some options are not available in every country. Contact your point of purchase for options available in your country.

Option	E220	E320	E321	E322	E322n	E323	E323n
Tray 2	Available	Available	Available	Available	Available	Available	Available
Memory	8MB, 16MB, 32MB, 64MB	8MB, 16MB, 32MB, 64MB	8MB, 16MB, 32MB, 64MB	8MB, 16MB, 32MB, 64MB	8MB, 16MB, 32MB, 64MB	8MB, 16MB, 32MB, 64MB	8MB, 16MB, 32MB, 64MB
Total possible	72MB	68MB	72MB	72MB	80MB	144MB	144MB
Flash	N/A	N/A	N/A	1, 2, 4MB	1, 2, 4MB	2, 4, 8, 16MB	2, 4, 8, 16MB

Note:

- N/A means not available
- Standard random access memory (RAM) is soldered on the controller card on both the E320/E322n and E220/E321/E323n.

Acronyms

ASF	Auto Sheet Feed
ASIC	Application-Specific Integrated Circuit
B/M	Bill of Material
CRC	Cyclic Redundancy Check
CRLF	Carriage Return Line Feed
DIMM	Dual Inline Memory Module
DRAM	Dynamic Random Access Memory
ENA	External Network Adapter
ESD	Electrostatic Discharge
FRU	Field Replaceable Unit
HBP	Host Based Printing
HVPS	High Voltage Power Supply
LASER	Light Amplification by Stimulated Emission of Radiation
LED	Light-Emitting Diode
LFCR	Line Feed Carriage Return
LVPS	Low Voltage Power Supply
NAND	Not AND
NVRAM	Nonvolatile Random Access Memory
OPC	Optical Photoconductor
PC	Photoconductor
PCB	Printed Circuit Board
PCL	Printer Command Language
PJL	Printer Job Language
PPM	Pages Per Minute
POR	Power-On Reset
POST	Power-On Self Test
PPDS	Personal Printer Data Stream
PSU	Power Supply Unit
PWM	Pulse Width Modulation
RAM	Random Access Memory
ROM	Read Only Memory
SIMM	Single Inline Memory Module
SRAM	Static Random Access Memory
THM	Thermistor
USB	Universal Serial Bus
V ac	Volts alternating current
V dc	Volts direct current

2. Diagnostic information

Start

Diagnostics (E320/E322)

Note: For diagnostic information about models E220/E321/E323 see “**Diagnostics (E220/E321/E323)**” on **page 2-35** for more information.

CAUTION: ***NEVER*** manually actuate or disable the top cover interlock switch and the printhead shutter actuator at the same time.

To perform some of the service checks and tests, such as troubleshooting paper feed problems, you need to actuate the top cover interlock switch with the covers open or removed and power applied to the machine. It is important for personal safety that you *DO NOT, FOR ANY REASON*, disable the printhead shutter actuator when power is on.

Unplug power from the printer before connecting or disconnecting any cable or electronic board or assembly for personal safety and to prevent damage to the printer.

Use the service error code, user error message, symptom table, service checks, and diagnostic aids in this chapter to determine the corrective action necessary to repair a malfunctioning printer.

The lights on the operator panel can indicate either a user error message or service error message. When a service error occurs, the printer stops printing and all operator panel lights blink in a continuous pattern, indicating a service error, until the printer is powered off. If all operator panel lights are blinking, go to the “**Service error codes**” on **page 2-11** for more information.

When a user error message occurs, one or more operator panel lights are on solid or blinking. See “**Status information**” on **page 2-3** for more information.

If the machine does not have a service error code and does not complete power-on self test (POST), go to the “**POST symptom table**” on **page 2-32**. If the machine completes POST without an error, and there is a symptom, go to the “**Printer symptom table**” on **page 2-33**. Locate the symptom and take the appropriate action.

4500–E320/E322

If a service error code appears while working on the machine, go to the **“Service error codes ” on page 2-11** and take the appropriate action.

Operator panel

The E320/E322 operator panel consists of six indicator lights and one button. The information provided by the six lights is classified into three groups:

- Status
- Attendance
- Service

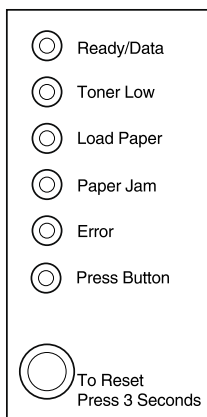

Depending on the light sequence, briefly (approximately one second) push the operator panel button to restart the printer, display an error code, or activate other printer functions.

The operator panel light table (see **page 2-3**) can be used to determine the type of message displayed based on which combination of lights are on or flashing.

Status information

The following symbols are used in the status, attendance, and service information tables:

Operator panel lights	Description
●	Operator panel light is on.
○	Operator panel light is off.
*	Operator panel light is blinking.
×	Operator panel light is blinking slowly.

Ready

The printer is in a **Ready** state.

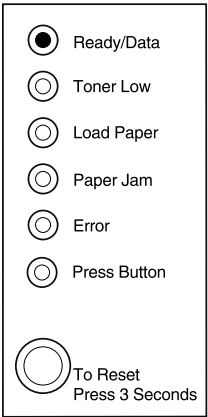

Ready indicates the printer is ready to receive and process data from the host system.

- Brief button press executes a print test.
- Long button press executes a printer reset.

Attendance information

When attendance information is displayed, the user is required to open the printer cover and clear all paper from the paper path. The user indicates the jam is cleared by closing the cover or by performing a brief button press.

Paper jam

A paper jam is detected.

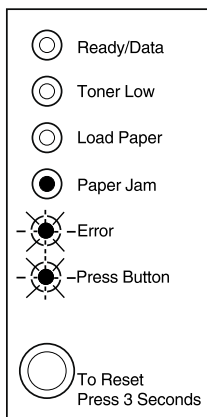

- Brief button press assumes the jam has been cleared. A warm-up is performed, and the print job resumes.
- Long button press is ignored.
- Open/close cover assumes the jam has been cleared. A warm-up is performed, and the job prints.

Host interface error

This error is generated when the printer detects an error communicating with the host computer. There are three causes of this error:

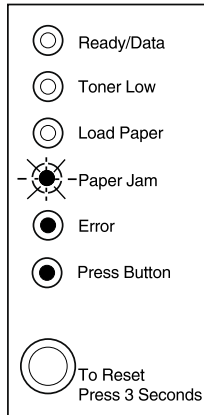

1. Parallel external network adapter (ENA) connection is lost during the printer's power-on cycle. Once a connection is initially established, a printer setting is modified to note that the connection exists. Then, each time the power is cycled on the printer, if the setting states a connection exists, the printer attempts to communicate with the adapter. If the adapter does not respond, a message is posted.

This error is only detected during the power-on cycle. This means if the external network adapter connection is lost after the power-on cycle is complete, this error is not detected. The printer cannot distinguish between an adapter which is quiet, for example, not sending any data, and an adapter which has been disconnected.

2. Standard parallel port disabled – this error is generated when the host computer attempts to communicate with the printer through the standard parallel port. However, the parallel port has been disabled either through the printer configuration mode, or through the MarkVision™ host utility
3. Standard USB port disabled – this error is generated when the host computer attempts to communicate with the printer through the standard USB port. However, the USB port has been disabled either through the printer configuration mode, or through the MarkVision host utility.

The error recovery process for this error is:

1. If this error occurs at power-on and an ENA is attached to the printer, verify the ENA is properly connected.
2. When the printer is in the **Ready** state, press the operator panel button to print a menus settings page.
3. Under the “parallel menu”, look for the “parallel buffer” line. If this line says “disabled” and the host computer is trying to print using the parallel port, re-enable the parallel port using MarkVision or the printers configuration mode.
4. Under the “USB menu”, look for the “USB buffer” line. If this line says “disabled” and the host computer is trying to print using the USB port, re-enable the USB port using MarkVision or the printer configuration mode.

See **“Configuration mode” on page 3-14** for information using the printer configuration mode to enable a disabled port.

Service information

There are three levels of service code information.

- Primary service error codes
- Secondary service error codes
- Subcodes (sub set of the secondary codes)

Service information is displayed whenever the printer is in the check state, and needs servicing. In general, service errors are not recoverable. However, it may be possible to turn the printer off and back on to temporarily recover from the error condition if it is intermittent.

When a service error occurs, the printer stops printing immediately. The only recovery is to turn off the printer.

The following operator panel is an example indicating a primary service error code condition.

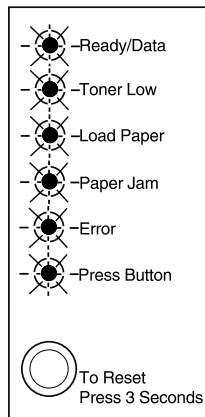

- Brief button press displays a service error code pattern.
- Long button press displays a service error code pattern.
- Double button press is not available.
- Open/close cover is ignored.

Primary service error codes

When a service error occurs, the printer stops printing and all operator panel lights blink in a continuous pattern, indicating a service error, until the printer is turned off.

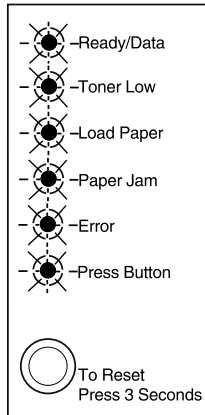

Press and release the operator panel button to display the secondary service error code.

Secondary service error codes

The operator panel button has been pushed and a secondary service error has occurred indicating a fuser failure.

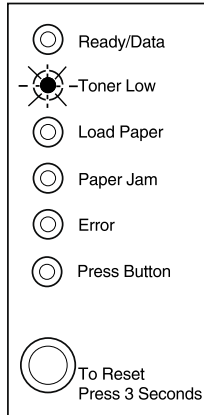

Once the error code is displayed, and if the operator panel button is pushed again, the operator panel displays the service error indication (all six indicator lights blinking). Continual pressing of the button causes the lights to repeat in the following order:

1. Service error indication
2. Fuser service error code indication
3. Service error indication

Subcode service error code

Pressing the operator panel button again, indicates a fuser failure–under temperature subcode.

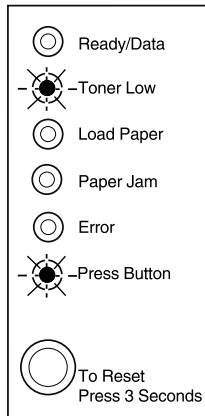

Once the subcode is displayed, if the operator panel button is pushed again, all six indicator lights blink. Continual pressing of the operator panel button causes the lights to repeat in the following order:

1. Service error indication
2. Fuser failure service error code indication
3. Fuser failure–under temperature service error subcode indication
4. Service error indication

Service error codes

Software service error code

The operator panel button has been pushed and a secondary service error has occurred indicating a software error.

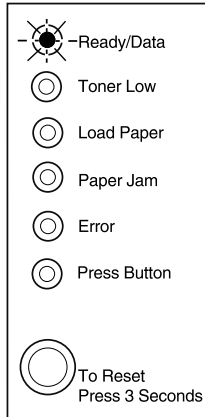

Once the error code is displayed, if the operator panel button is pushed again, the operator panel will display the service error indication (all six indicator lights blinking). Continual pressing of the operator panel button causes the lights to repeat in the following order:

1. Service error indication
2. Software service error code indication
3. Service error indication

Place the printer into the special function menu and run a print test. See **“Using the special function menu (E320/E322)” on page 2-105** for more information. If the printer does not run printer diagnostics, replace the controller card.

Fuser failure—over temperature error code

The operator panel is indicating a fuser failure—over temperature subcode.

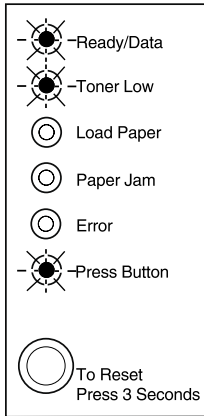

See **“Hot fuser service check ” on page 2-76** for more information.

Fuser failure—under temperature error code

The operator panel is indicating a fuser failure—under temperature subcode.

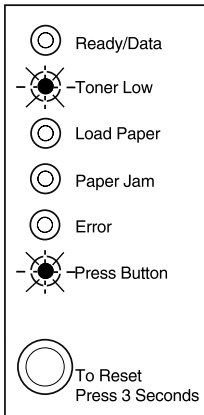

See **“Hot fuser service check ” on page 2-76** for more information.

Fuser failure–under temperature error code–standby

The operator panel is indicating a fuser failure–under temperature subcode.

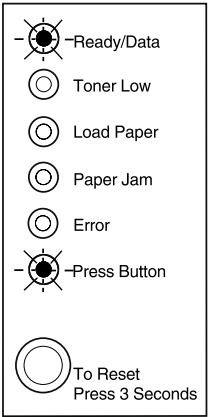

See **“Hot fuser service check ” on page 2-76** for more information.

Fuser failure–under temperature error code–while printing

The operator panel is indicating a fuser failure–under temperature subcode. See **“Hot fuser service check ” on page 2-76** for more information.

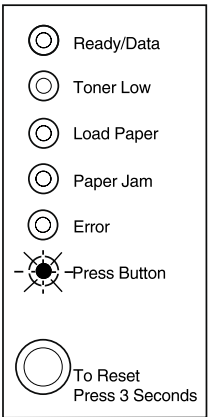

4500–E320/E322

Fuser failure–thermistor open error code

The operator panel is indicating a fuser failure–thermistor open subcode.

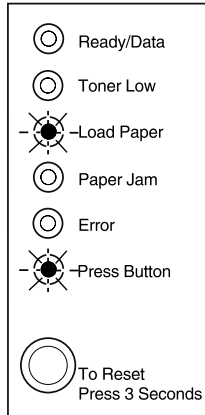

Replace the fuser assembly.

Mirror motor failure service error code

The operator panel button has been pushed and a mirror motor failure service error has occurred.

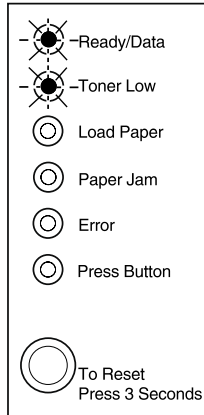

Once the error code is displayed, if the operator panel button is pushed again, the operator panel displays the service error indication (all six indicator lights blinking). Continual pressing of the operator panel button causes the lights to repeat in the following order:

1. Service error indication
2. Mirror motor failure service error code indication
3. Service error indication

Inspect the printhead cable and replace the assembly as necessary. If this does not correct the problem, replace the engine/low voltage power supply (LVPS) board.

Optional memory service error code

The operator panel button has been pushed and a memory service error has occurred.

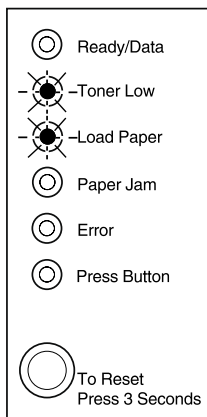

Once the error code is displayed, if the operator panel button is pushed again, the operator panel displays the service error indication (all six indicator lights blinking). Continual pressing of the operator panel button causes the lights to repeat in the following order:

1. Service error indication
2. Optional memory service error code indication
3. Service error indication

Replace the optional memory, dual inline memory module (DIMM). If this does not correct the problem, replace:

- The code overlay
- Read only memory (ROM)
- Flash single inline memory module (SIMM) or
- The controller card.

ROM checksum failure service error code

The operator panel button has been pushed and a ROM checksum failure service error has occurred.

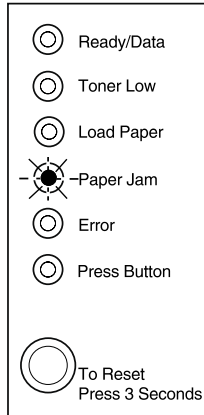

Once the error code is displayed, if the operator panel button is pushed again, the operator panel displays the service error indication (all six indicator lights blinking). Continual pressing of the operator panel button causes the lights to repeat in the following order:

1. Service error indication
2. ROM checksum failure service error code indication
3. Service error indication

Replace the ROM SIMM. If this does not correct the problem, replace the controller card.

Base memory service error code

The operator panel button has been pushed and a base memory service error has occurred.

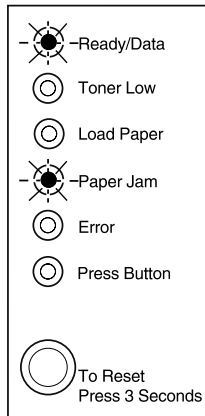

Once the error code is displayed, if the operator panel button is pushed again, the operator panel will display the service error indication (all six indicator lights blinking). Continual pressing of the operator panel button causes the lights to repeat in the following order:

1. Service error indication
2. Base memory service error code indication
3. Service error indication

Replace the controller card.

NVRAM failure service error code

The operator panel button has been pushed and a nonvolatile random access memory (NVRAM) failure service error has occurred.

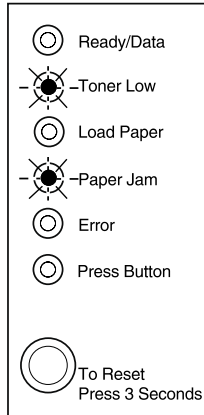

Once the error code is displayed, if the operator panel button is pushed again, the operator panel displays the service error indication (all six indicator lights blinking). Continual pressing of the operator panel button causes the lights to repeat in the following order:

1. Service error indication
2. NVRAM failure service error code indication
3. Service error indication

Replace the engine board.

ASIC register failure service error code

The operator panel button has been pushed and an application–specific integrated circuit ASIC register failure service error has occurred.

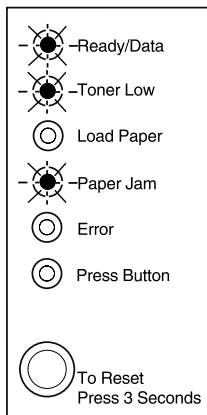

Once the error code is displayed, if the operator panel button is pushed again, the operator panel displays the service error indication—all six indicator lights blinking. Continual pressing of the operator panel button causes the lights to repeat in the following order:

1. Service error indication
2. ASIC register failure service error code indication
3. Service error indication

Replace the controller card.

ASIC static random access memory (SRAM) failure service error code

The operator panel button has been pushed and an ASIC SRAM failure service error has occurred.

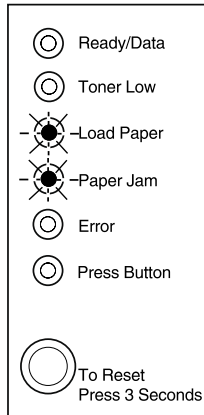

Once the error code is displayed, if the operator panel button is pushed again, the operator panel displays the service error indication (all six indicator lights blinking). Continual pressing of the operator panel button causes the lights to repeat in the following order:

1. Service error indication
2. ASIC SRAM failure service error code indication
3. Service error indication

Replace the controller card.

Flash memory failure service error code

The operator panel button has been pushed and a flash memory failure service error has occurred.

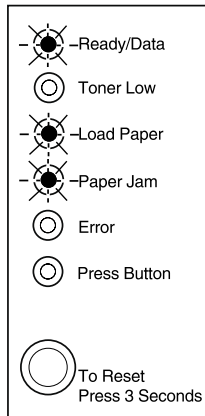

Once the error code is displayed, if the operator panel button is pushed again, the operator panel displays the service error indication (all six indicator lights blinking). Continual pressing of the operator panel button causes the lights to repeat in the following order:

1. Service error indication
2. Flash memory failure service error code indication
3. Service error indication

Replace the flash memory. If this does not correct the problem, replace the controller card.

Font checksum failure service error code

The operator panel button has been pushed and a font checksum failure service error has occurred.

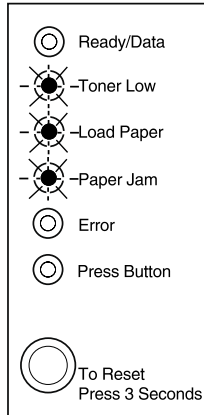

Once the error code is displayed, if the operator panel button is pushed again, the operator panel displays the service error indication (all six indicator lights blinking). Continual pressing of the operator panel button causes the lights to repeat in the following order:

1. Service error indication
2. Font checksum failure service error code indication
3. Service error indication

Replace the ROM SIMM. If this does not correct the problem, replace the controller card.

Engine communication failure service error code

The operator panel button has been pushed and an engine communication failure service error has occurred.

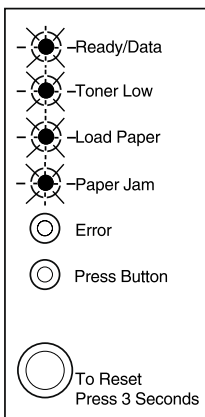

Once the error code is displayed, if the operator panel button is pushed again, the operator panel displays the service error indication (all six indicator lights blinking). Continual pressing of the operator panel button causes the lights to repeat in the following order:

1. Service error indication
2. Engine communication failure service error code indication
3. Service error indication

Replace the engine board.

Error codes/conditions not detected or reported

The printer does not detect or report the following conditions/errors:

- Incorrect manual feed
- Output bin full
- Print cartridge missing (reported as “top cover open” error)

Operator panel light summary table

Operator panel light	Description
●	Operator panel light is on.
○	Operator panel light is off.
*	Operator panel light is blinking.
×	Operator panel light is blinking slowly.

Error code table

Ready /Data	Toner Low	Load Paper	Paper Jam	Error	Press Button	Condition
●	○	○	○	○	○	Ready
●	○	○	○	○	*	Demo ready
○	○	○	○	○	●	Offline (remote)
*	○	○	○	○	○	Busy
●	○	○	○	○	●	Waiting
●	●	●	●	●	●	<ul style="list-style-type: none"> • Restoring factory defaults • Saving settings • Resetting printer
*	○	○	○	*	○	Flushing buffer
×	○	○	○	○	○	Hex Trace
○	○	○	●	○	○	Paper jam
○	○	*	○	○	●	Load manual paper/envelope
○	○	●	○	○	●	Load paper/envelope Tray 1 or Tray 2
○	○	●	○	○	*	Load paper Tray 1 for side 2 of manual duplex
○	○	○	○	●	○	Top cover open

Ready /Data	Toner Low	Load Paper	Paper Jam	Error	Press Button	Condition
○	*	○	○	●	○	Toner cartridge error
○	○	○	○	●	●	Printer error
○	○	○	○	*	●	Flash memory full
○	○	●	●	○	○	Diagnostic test mode
Operator panel lights when toner is low						
●	●	○	○	○	○	Ready and Toner Low
●	●	○	○	○	*	Demo ready and toner low
○	●	○	○	○	●	Offline (remote) and toner low
*	●	○	○	○	○	Busy and toner low
●	●	○	○	○	●	Waiting and toner low
●	●	●	●	●	●	<ul style="list-style-type: none"> • Restoring factory defaults • Saving settings • Resetting printer and toner low
*	●	○	○	*	○	Flushing buffer and toner low
×	●	○	○	○	○	Hex Trace and toner low

4500–E320/E322

Ready /Data	Toner Low	Load Paper	Paper Jam	Error	Press Button	Condition
○	●	○	●	○	○	Paper jam and toner low
○	●	*	○	○	●	Load manual paper/ envelope and toner low
○	●	●	○	○	●	Load paper/ envelope Tray 1 and toner low
○	●	●	○	○	*	Load paper Tray 1 for side 2 of manual duplex and toner low
○	●	×	○	○	●	Load paper Tray 2 and toner low
○	●	○	○	●	○	Top cover open and toner low
○	*	○	○	●	○	Toner cartridge error
○	●	○	○	●	●	Printer error and toner low
○	●	○	○	*	●	Flash memory full and toner low
○	●	●	●	○	○	Diagnostic test mode and toner low
Printer error secondary codes						
●	●	○	○	●	●	Memory full

Ready /Data	Toner Low	Load Paper	Paper Jam	Error	Press Button	Condition
●	○	○	○	●	●	Complex page
●	○	●	○	●	●	Short paper
●	●	●	○	●	●	Toner low intervention
*	*	○	○	●	●	Resolution reduction warning
○	*	○	○	●	●	Font error
*	○	○	○	●	●	Resource save off-deficient memory
○	○	*	○	●	●	Insufficient defrag memory
○	○	○	*	●	●	Host interface error (parallel ENA connection lost, standard parallel port disabled, standard USB port disabled)

Ready /Data	Toner Low	Load Paper	Paper Jam	Error	Press Button	Condition
Service error codes						
For some service error codes, a second service error code is used to further describe the error. When a service error occurs, pressing the operator panel button after viewing the primary service error code displays the secondary service error code. The following table contains the secondary service error codes.						
Primary service error codes						
*	*	*	*	*	*	Service error, see page 2-8.
Secondary service error codes						
*	○	○	○	○	○	Software error see page 2-11.
○	*	○	○	○	○	Fuser failure see page 2-12.
*	*	○	○	○	○	Mirror motor failure see page 2-15.
○	*	*	○	○	○	Optional memory see page 2-16.
○	○	○	*	○	○	ROM checksum see page 2-17.
*	○	○	*	○	○	Base memory see page 2-18.
○	*	○	*	○	○	NVRAM failure see page 2-19.

Ready /Data	Toner Low	Load Paper	Paper Jam	Error	Press Button	Condition
*	*	○	*	○	○	ASIC register failure see page 2-20 .
○	○	*	*	○	○	ASIC SRAM failure see page 2-21 .
*	○	*	*	○	○	Flash memory failure see page 2-22 .
○	*	*	*	○	○	Font checksum see page 2-23 .
*	*	*	*	○	○	Engine communication failure see page 2-24 .
Fuser service error subcodes						
*	*	○	○	○	*	Fuser failure—over temperature see page 2-12 .
○	*	○	○	○	*	Fuser failure—under temperature see page 2-12 .
○	○	*	○	○	*	Fuser failure—thermistor open see page 2-14 .

POST

When you turn the printer on, it performs a power–on self test. Check for correct POST functioning of the base printer by observing the following:

Symptom tables

POST symptom table

Symptom	Action
The main motor, cooling fan, and fuser do not come on.	See the “Cover interlock switch service check (E320/E322)” on page 2-69.
POST completes except one or more lights do not come on.	See the “Main motor service check ” on page 2-77.
None of the lights come on.	See the “Operator panel service check ” on page 2-79.
Main motor does not come on.	See the “Main motor service check ” on page 2-77.
Fan does not come on.	See the “Cooling fan service check (E320/E322)” on page 2-65.
Fuser lamp does not come on.	See the “Cold fuser service check ” on page 2-64.
Fuser lamp never turns off.	See the “Hot fuser service check ” on page 2-76.
The paper feed picks and tries to feed paper.	See the “Paper feed service checks ” on page 2-81.

Printer symptom table

Symptom	Action
Dead machine (no power)	See the “Dead machine service check ” on page 2-71.
Fan noisy or not working	See the “Cooling fan service check (E320/E322) ” on page 2-65 or “Cooling fan service check (E220/E321/E323) ” on page 2-66.
Fuser parts melted	See the “Hot fuser service check ” on page 2-76.
Fuser lamp doesn't light	See the “Hot fuser service check ” on page 2-76.
Toner not fused to the paper	See the “Hot fuser service check ” on page 2-76.
Main motor noisy or not moving	See the “Main motor service check ” on page 2-77.
Paper skew	See the “Paper feed service checks ” on page 2-81.
Printer not communicating with host	See the “Parallel port service check ” on page 2-85.
Top cover will not close	See the “Cover interlock switch service check (E320/E322) ” on page 2-69 or “Cover interlock switch service check (E220/E321/E323) ” on page 2-70.
Operator panel button not responding	See the “Operator panel button service check ” on page 2-78.
Operator panel lights do not light or very dim	See the “Operator panel service check ” on page 2-79.
Blank page	See the “Blank page ” on page 2-86.
Black page	See the “Black page ” on page 2-87.
Heavy background	See the “Heavy background ” on page 2-88.
Light print	See the “Light print ” on page 2-90.

Symptom	Action
White or black lines or bands	See the “White or black lines or bands ” on page 2-91.
Toner on back of page	See the “Toner on back of page ” on page 2-91.
Paper jams	See the “Paper feed service checks ” on page 2-81.
Paper never picks	See the “Paper never picks ” on page 2-83.
Paper feeds continuously	See the “Paper picks during POST and/or continuously ” on page 2-81.
Paper wrinkled or bent	See the “Paper “trees,” wrinkles, stacks poorly or curls ” on page 2-84.

Diagnostics (E220/E321/E323)

Note: For diagnostic information about models E320/E323 see **“Diagnostics (E320/E322)” on page 2-1** for more information.



CAUTION: Unplug power from the printer before connecting or disconnecting any cable, assembly, or electronic card. This is a precaution for personal safety and to prevent damage to the printer.

The lights on the operator panel indicate the status of the printer anytime it is powered on. When the printer experiences a problem requiring operator intervention, it indicates the source by blinking one or more lights. See **“Status information light patterns” on page 2-38** for more information. When all six lights blink simultaneously, a service may need to be performed. See **“Service error codes” on page 2-45** for more information.

If the printer does not indicate a service error code nor complete POST without an error but there is a symptom, see **“Symptom tables” on page 2-60** for more information.

Operator panel

The operator panel consists of six indicator lights and two buttons.

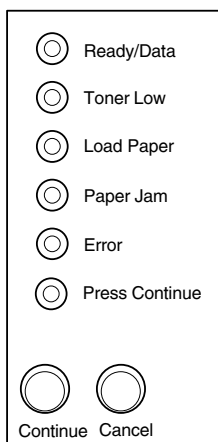

Note: Traditional printer settings such as paper source, paper size, and orientation may not be selected or modified using the operator panel with the exception that U.S. versus non–U.S. may be chosen in the diagnostic mode. Users must either utilize an application print driver and/or the printer toolkit to modify settings.

The operator panel may be used for:

- Determining printer status (See **“Status information light patterns ” on page 2-38** for more information.)
- Reviewing printer settings (See **“Power–On Self Test (POST) ” on page 2-60** for more information.)
- Changing printer settings (See **“Power–on operations ” on page 2-59** for more information.)
- Utilizing diagnostic tools (See **“Power–on operations ” on page 2-59** for more information.)
- Obtaining information about printer service errors (See **“Service error codes ” on page 2-45** for more information.)

Light patterns

The following symbols are used in the status, attendance, and service information tables.

Operator panel light	Description
●	Operator panel light is on.
○	Operator panel light is off.
*	Operator panel light is blinking.
×	Operator panel light is blinking slowly.

Status information light patterns

Ready/Data	Toner Low	Load/Remove Paper	Paper Jam	Error	Press Continue	Status
●	○	○	○	○	○	Ready
●	○	○	○	○	*	Demo ready
×	○	○	○	○	○	Hex Trace ready
*	○	○	○	○	○	Busy
●	○	○	○	○	●	Waiting
●	●	○	○	○	○	Ready, with toner low warning
●	●	○	○	○	*	Demo ready, with toner low warning
×	●	○	○	○	○	Hex Trace ready, with toner low warning
*	●	○	○	○	○	Busy, with toner low warning
●	●	○	○	○	●	Waiting, with toner low warning
*	○	○	○	*	○	Flushing
●	●	●	●	●	●	Canceling job / resetting printer /activating changes
All lights cycling						Restarting printer
○	○	●	●	○	○	Diagnostics–memory test
●	●	●	○	○	○	Programming system code– <i>DO NOT POWER OFF</i> Note: The Error and Press Continue lights cycle through four different patterns to indicate progress during programming.

Ready/Data	Toner Low	Load/Remove Paper	Paper Jam	Error	Press Continue	Status
*	*	*	○	○	○	Programming system code partially complete—download system code data
●	○	○	○	●	○	Invalid engine code / invalid network code Note: A double press of Continue , causes a secondary light pattern which indicates further information on the type of invalid code status exists. See “ Invalid code secondary light patterns ” on page 2-40 .

Invalid code secondary light patterns

Ready/Data	Toner Low	Load/Remove Paper	Paper Jam	Error	Press Continue	Status
●	○	●	○	●	○	Invalid engine code
●	○	*	○	●	○	Invalid network code

Paper Jam secondary light patterns

Ready/Data	Toner Low	Load/Remove Paper	Paper Jam	Error	Press Continue	Attendance Condition
●	○	○	●	○	●	Paper jam–input sensor
○	●	○	●	○	●	Paper jam–exit sensor
○	*	○	●	○	●	Paper jam–duplex sensor
○	○	●	●	○	●	Paper jam–fuser exit sensor
*	○	○	●	○	●	Paper jam–multipurpose feeder sensor

Printer error secondary light patterns

To obtain the secondary light pattern, quickly press **Continue** twice.

Ready/Data	Toner Low	Load/Remove Paper	Paper Jam	Error	Press Continue	Attendance Condition
●	○	○	○	●	●	Complex page
○	●	○	○	●	●	Insufficient collation area
○	○	●	○	●	●	Defective flash
○	○	○	●	●	●	Network interface error
*	○	○	○	●	●	Resource save off–deficient memory
○	*	○	○	●	●	Personal printer data stream (PPDS) font error
○	○	*	○	●	●	Insufficient defrag memory
○	○	○	*	●	●	ENA connection lost
●	●	○	○	●	●	Memory full
●	○	●	○	●	●	Short paper
●	○	○	●	●	●	Flash full
○	●	●	○	●	●	Too many flash options
○	●	○	●	●	●	Engine code failure

Service information light patterns

Ready/Data	Toner Low	Load/Remove Paper	Paper Jam	Error	Press Continue	Service Condition
*	*	*	*	*	*	Service error Note: A double press of Continue causes a secondary light pattern which indicates further information on the type of printer error. See “Service error codes ” on page 2-11 for more information.

Service error secondary light patterns

Quickly press and release **Continue** twice to obtain the secondary light pattern.

Ready/Data	Toner Low	Load/Remove Paper	Paper Jam	Error	Press Continue	Service Condition
*	○	○	○	○	○	Software error (90x)
*	○	○	○	○	*	Transfer roll error (91x)
*	○	○	○	*	○	Fuser / toner sensor error (92x)
*	○	○	○	*	*	Printhead / transport motor / RIP to engine error (93x)
*	○	○	*	○	○	RIP to engine / engine communication error (94x)
*	○	○	*	○	*	NVRAM / ROM / not AND (NAND) error (95x)
*	○	○	*	*	○	RAM memory error (96x)
*	○	○	*	*	*	Network error (97x)
*	○	*	○	○	○	Paper port communication error (98x)

Note: There are many tertiary codes following these secondary codes. The following pages show these codes.

Obtaining information about printer service error codes

All lights flashing simultaneously designates a printer service error as a primary code. Double press **Continue** to see the secondary codes; double press **Continue** again to see the tertiary codes; double press **Continue** the third time to return to the primary code.

All secondary codes have a flashing Ready/Data light but not the Toner Low light. All tertiary codes have a flashing Toner Low light but not a Ready/Data light.



















All lights flashing simultaneously, as a result of sending data to the printer, may indicate a code problem. Call Lexmark Customer Support Center at 1–800–539–6275 for assistance.

Service error codes

Service error codes are generally non-recoverable except in an intermittent condition when you can power-on reset (POR) the printer to temporarily recover from the error condition.

Controller software error / illegal trap

Contact the next level of support or call Lexmark 1–800–539–6275 for assistance.

Primary Code	Secondary Code	Tertiary Codes
 Ready/Data	 Ready/Data	 Ready/Data
 Toner Low	 Toner Low	 Toner Low
 Load/ Remove Paper	 Load/ Remove Paper	 Load/ Remove Paper
 Paper Jam	 Paper Jam	 Paper Jam
 Error	 Error	 Error
 Press Continue	 Press Continue	 Press Continue

(900)

Engine flash or engine software errors



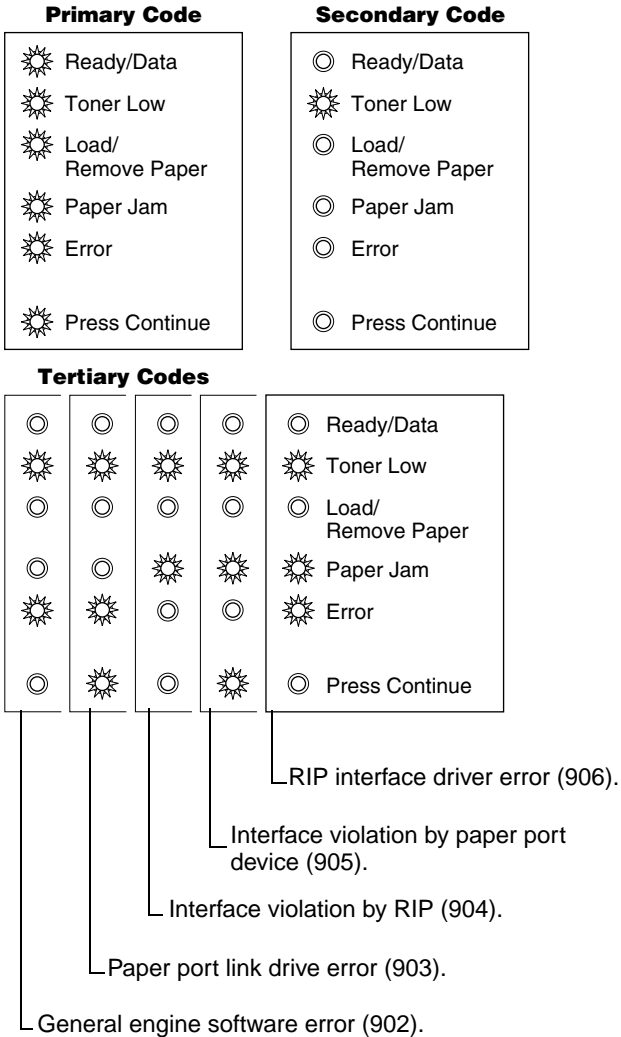



The first error message below (901) indicates the flash into which the engine code is programmed is bad. Either the flash cannot be erased or the program failed when programming was attempted. The remaining errors, 902 through 906, indicate an unrecoverable engine software error. Replace the controller card.









Transfer roll error

Indicates a problem in the transfer roll area. Check the cable from the HVPS (CN1) to the controller card (J3). Also, check voltage at pin #4 of J3.







Primary Code

	Ready/Data
	Toner Low
	Load/ Remove Paper
	Paper Jam
	Error
	Press Continue

Secondary Code

	Ready/Data
	Toner Low
	Load/ Remove Paper
	Paper Jam
	Error
	Press Continue

Tertiary Codes







	Ready/Data
	Toner Low
	Load/ Remove Paper
	Paper Jam
	Error
	Press Continue

(917)







Fuser error

Indicates a problem with the fuser. See the **“Fuser service check ”** on page 2-74 for more information.





































Primary Code

	Ready/Data
	Toner Low
	Load/ Remove Paper
	Paper Jam
	Error
	Press Continue

Secondary Code

	Ready/Data
	Toner Low
	Load/ Remove Paper
	Paper Jam
	Error
	Press Continue





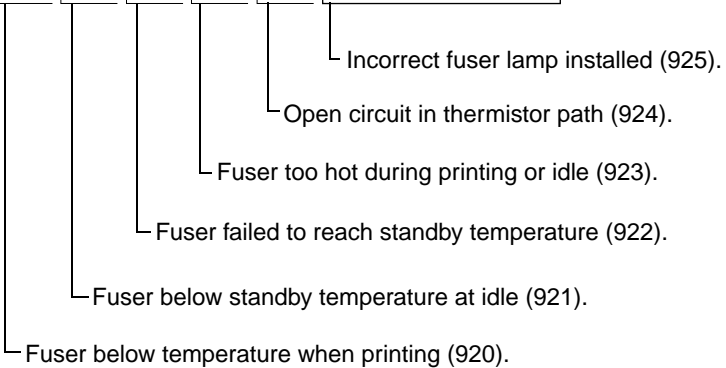













Tertiary Codes

						Ready/Data
						Toner Low
						Load/ Remove Paper
						Paper Jam
						Error
						Press Continue



Fan stalled



















Indicates a printer fan stall.

Primary Code	Secondary Code	Tertiary Codes
 Ready/Data	 Ready/Data	 Ready/Data
 Toner Low	 Toner Low	 Toner Low
 Load/ Remove Paper	 Load/ Remove Paper	 Load/ Remove Paper
 Paper Jam	 Paper Jam	 Paper Jam
 Error	 Error	 Error
 Press Continue	 Press Continue	 Press Continue

(927)

Toner sensor error

Indicates a problem with either the toner sensor or print cartridge.

Primary Code	Secondary Code	Tertiary Codes
 Ready/Data	 Ready/Data	 Ready/Data
 Toner Low	 Toner Low	 Toner Low
 Load/ Remove Paper	 Load/ Remove Paper	 Load/ Remove Paper
 Paper Jam	 Paper Jam	 Paper Jam
 Error	 Error	 Error
 Press Continue	 Press Continue	 Press Continue

(929)

Either the printer's toner sensor is faulty or the print cartridge is defective.





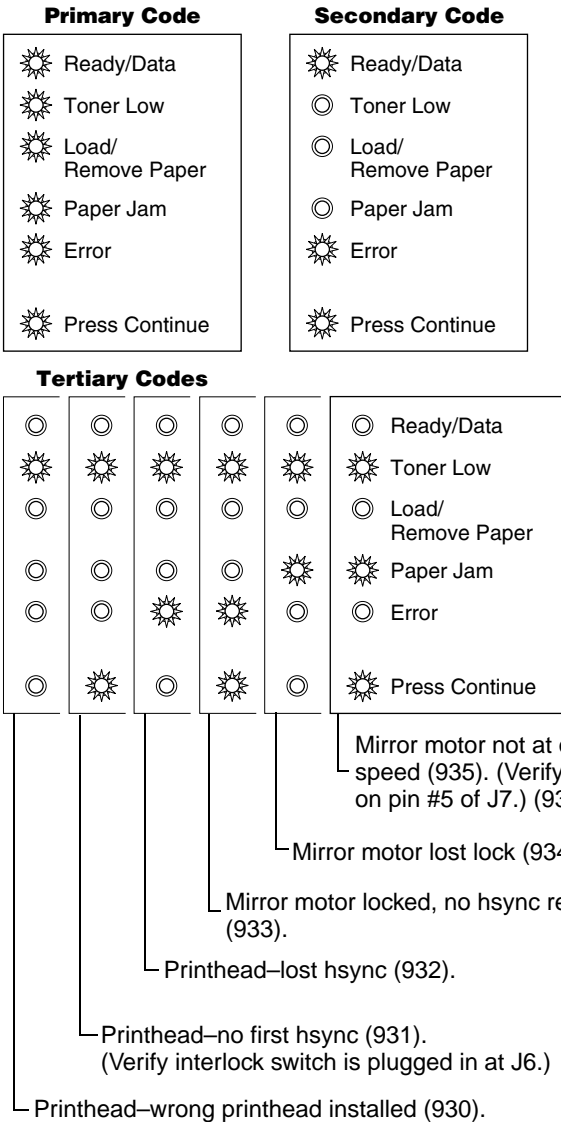



















Printhead error

Indicates a problem with the printhead. Check cables to the printhead. Replace the printhead as necessary. See “**Printhead assembly**” on page 4-2 for realignment procedures.





















Transport motor error

Indicates a problem with the main drive motor system. The problem could be the motor, the controller card, the cabling, or the drive assembly. Check the cable connectors. The tertiary code below, with four flashing lights indicates a problem in the drive assembly.

Primary Code	Secondary Code	Tertiary Codes
 Ready/Data  Toner Low  Load/ Remove Paper  Paper Jam  Error  Press Continue	 Ready/Data  Toner Low  Load/ Remove Paper  Paper Jam  Error  Press Continue	  Ready/Data   Toner Low   Load/ Remove Paper   Paper Jam   Error   Press Continue
		<p>└─ Transport motor lost lock (937).</p> <p>└─ Transport motor initial lock failure (936).</p>

RIP to engine communication failure (controller card)

Indicates that the RIP processor cannot communicate with the engine processor.





Primary Code	Secondary Code	Tertiary Codes
 Ready/Data  Toner Low  Load/ Remove Paper  Paper Jam  Error  Press Continue	 Ready/Data  Toner Low  Load/ Remove Paper  Paper Jam  Error  Press Continue	 Ready/Data  Toner Low  Load/ Remove Paper  Paper Jam  Error  Press Continue

(939)

RIP to engine communication failure (controller card)





Indicates a failure in the zero crossing signal which is used for fuser control. It may indicate the wrong LVPS has been installed.

Primary Code

-  Ready/Data
-  Toner Low
-  Load/
Remove Paper
-  Paper Jam
-  Error





-  Press Continue

Secondary Code

-  Ready/Data
-  Toner Low
-  Load/
Remove Paper
-  Paper Jam
-  Error

-  Press Continue

Tertiary Codes













-  Ready/Data
-  Toner Low
-  Load/
Remove Paper
-  Paper Jam
-  Error



















-  Press Continue

(940)

Engine circuitry failure (controller card)

Indicates a failure in the engine circuitry portion of the controller card.

Primary Code	Secondary Code
 Ready/Data	 Ready/Data
 Toner Low	 Toner Low
 Load/ Remove Paper	 Load/ Remove Paper
 Paper Jam	 Paper Jam
 Error	 Error
 Press Continue	 Press Continue

Tertiary Codes		
		 Ready/Data
		 Toner Low
		 Load/ Remove Paper
		 Paper Jam
		 Error
		 Press Continue

Delay line calibration failure (949).

Pel clock check failure (948).

(947)

- PQET RAM test incomplete.
- PQET RAM test did not complete.
- PQET RAM test failed MARCH0.
- PQET RAM test failed MARCH1.
- PQET RAM test busy failure.

NVRAM failure

Indicates a problem in the NVRAM. Replace the operator panel assembly.

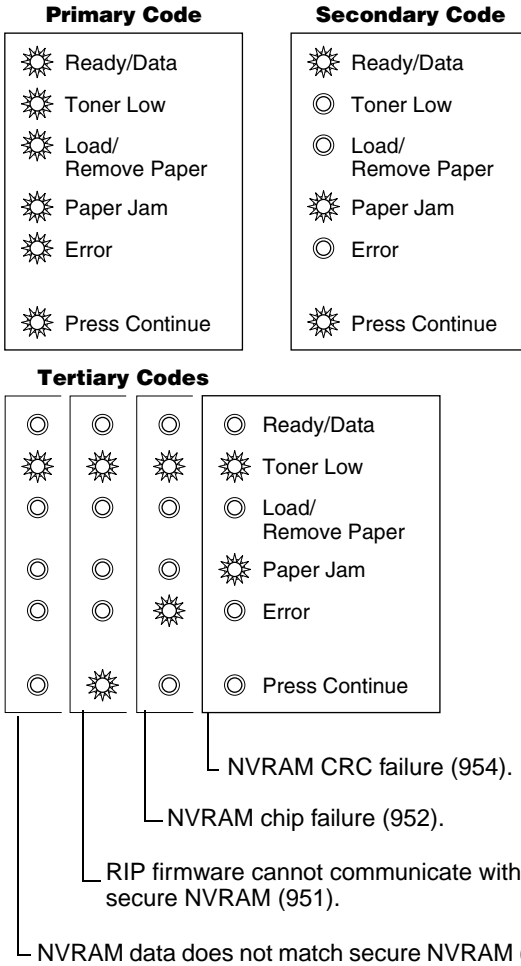







Note: NVRAM is on the operator panel printed circuit board (PCB) while secure NVRAM is on the controller PCB. Check margin alignments after replacing the operator panel assembly. See **“Printhead assembly ” on page 4-2** (steps 1 through 11) for more information. If margin errors are unacceptable, corrections can only be made through software. Contact the next level of support or Lexmark at 1–800–539–6275.







Controller card error (ROM / NAND)

Indicates a failed controller card assembly. Replace the controller card.































Primary Code

	Ready/Data
	Toner Low
	Load/ Remove Paper
	Paper Jam
	Error
	Press Continue

Secondary Code

	Ready/Data
	Toner Low
	Load/ Remove Paper
	Paper Jam
	Error
	Press Continue

Tertiary Codes

					Ready/Data
					Toner Low
					Load/ Remove Paper
					Paper Jam
					Error
					Press Continue

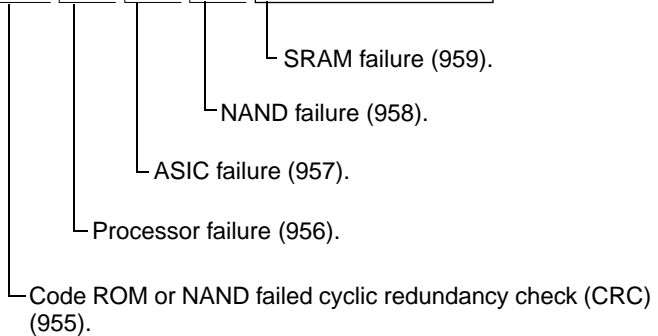

RAM memory error

This error indicates RAM failure. Remove DIMM(s) and re–POR the printer. If the error persists, replace the card. If the error subsides, check each DIMM independently. Replace faulty DIMM.

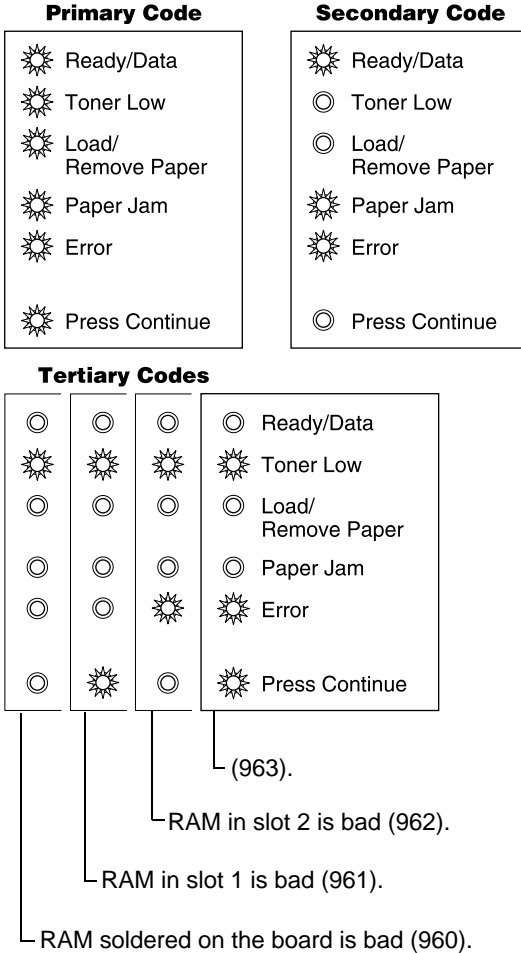

Network error

Indicates an error in the network circuitry. Replace the controller card assembly.

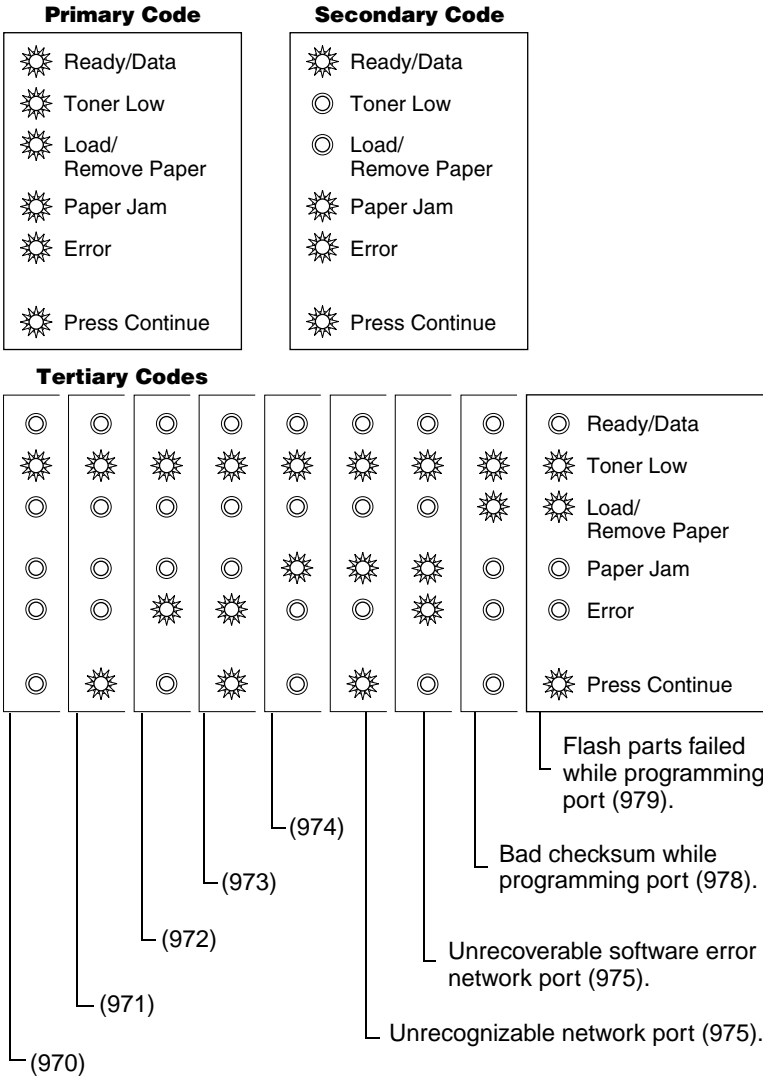

Paper port communication failure

Indicates an error communicating with Tray 2, if installed. Remove Tray 2 and recheck. If the error doesn't recur, replace Tray 2. If the error recurs, replace the controller card assembly.

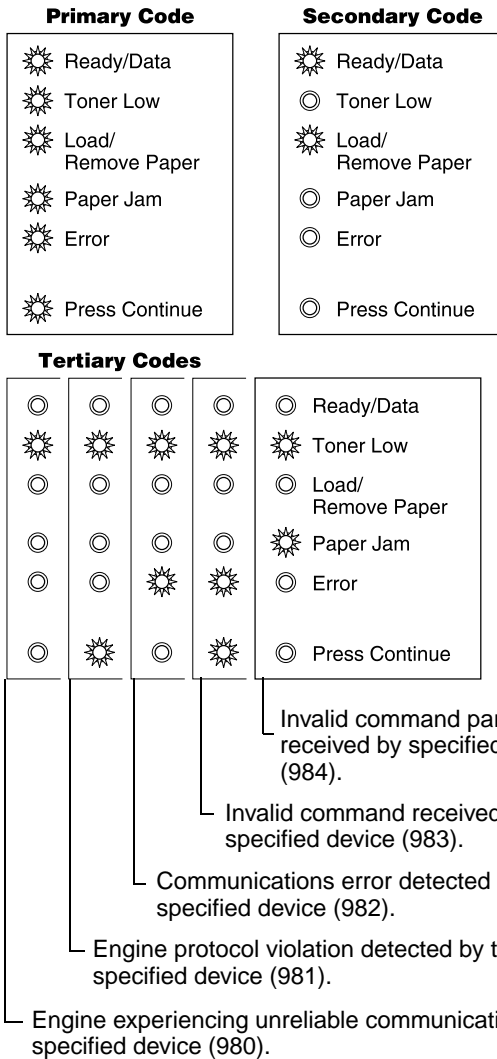

Power-on operations

To access the printer operations for the E220, E321, E323:

1. Turn off the printer.
2. Press and hold the buttons in the following table for the operation needed.
3. Turn on the printer. Hold the buttons until the lights cycle on the operator panel.
4. Print menus by closing the top cover and then pressing **Continue** until the lights flash (see samples on [page 3-38](#) and [page 3-39](#)).

Operation	Power-on action
Enter configuration menu mode	<ol style="list-style-type: none"> 1. Power on with top cover open and Continue pressed. 2. Close cover once the Error light is displayed.
Print the print quality test pages	In configuration mode, press and release Cancel until the top two lights come on. Press and hold Continue until lights flash. See the note in item 3 page 3-40 for more information (Cartridge Lockout function enabled).
Enter diagnostics mode	<ol style="list-style-type: none"> 1. Power on with top cover open and Cancel pressed. 2. Close cover once the Error light is displayed.
Print the print quality test pages	In diagnostic mode, press and release Cancel until the top two lights come on. Press and hold Continue until lights are on. Press and hold Continue until lights flash. See the note in item 3 page 3-40 for more information. (Cartridge Lockout function disabled)
Reset NVRAM and enter normal mode	<ol style="list-style-type: none"> 1. Power on with top cover open and both Continue and Cancel buttons pressed. 2. Close cover once the Error light is displayed.

Power–On Self Test (POST)

When you turn the printer on, it performs a power–on self test. Check for correct POST functioning of the base printer by observing the following symptoms:

Symptom tables

POST symptom table

Symptom	Action
The main motor, cooling fan, and fuser do not come on.	See the “Cover interlock switch service check (E220/E321/E323)” on page 2-70.
POST completes except one or more lights do not come on.	See the “Operator panel service check” on page 2-79.
None of the lights come on.	See the “Operator panel service check” on page 2-79.
Main motor does not come on.	See the “Main motor service check” on page 2-77.
Fan does not come on.	See the “Cooling fan service check (E220/E321/E323)” on page 2-66.
Fuser lamp does not come on.	See the “Cold fuser service check” on page 2-64.
Fuser lamp never turns off.	See the “Hot fuser service check” on page 2-76.
The paper feed picks and tries to feed paper.	See the “Paper feed service checks” on page 2-81.

Printer Symptom Table

Symptom	Action
Dead machine (no power)	See “Dead machine service check ” on page 2-71.
Fan noisy or not working	See “Cooling fan service check (E320/E322) ” on page 2-65 or “Cooling fan service check (E220/E321/E323) ” on page 2-66.
Fuser parts melted	See “Hot fuser service check ” on page 2-76.
Fuser lamp doesn't light	See “Cold fuser service check ” on page 2-64.
Toner not fused to the paper	See “Cold fuser service check ” on page 2-64.
Paper jams	See “Paper feed service checks ” on page 2-81.
Main motor noisy or not moving	See “Main motor service check ” on page 2-77.
Paper skew	See the Note regarding alignment on page 4-2 or “Paper feed service checks ” on page 2-81.
Printer not communicating with host	See “Parallel port service check ” on page 2-85.
Top cover will not close	See “Cover interlock switch service check (E320/E322) ” on page 2-69 or “Cover interlock switch service check (E220/E321/E323) ” on page 2-70.
Operator panel button not responding	See “Operator panel service check ” on page 2-79 or “Controller card service check (E220/E321/E323) ” on page 2-67.
Operator panel lights do not light or are very dim	See “Controller card service check (E220/E321/E323) ” on page 2-67.
Blank page	See “Blank page ” on page 2-86.
Black page	See “Black page ” on page 2-87.

Symptom	Action
Heavy background	See “Heavy background ” on page 2-88.
Light print	See “Light print ” on page 2-90.
White or black lines or bands	See “White or black lines or bands ” on page 2-91.
Toner on back of page	See “Toner on back of page ” on page 2-91.
Paper never picks	See “Paper never picks ” on page 2-83.
Paper feeds continuously	See “Paper picks during POST and/or continuously ” on page 2-81.
Paper wrinkled or bent	See “Paper “trees,” wrinkles, stacks poorly or curls ” on page 2-84.

Service checks



Service checks which involve measuring voltages of the LVPS/engine boards must be performed with the printer positioned on its back side. This provides the servicer access to the circuit boards underneath the printer while supplying necessary power to the rest of the printer.

Cold fuser service check

Make sure the correct voltage lamp is installed. The voltage rating is stamped on one of the lamp contacts.

FRU	Action
<p>Fuser lamp Lamp cable LVPS Fuser</p> 	<p>If the fuser lamp comes on and a fuser failure light error code displays, be sure the thermistor is contacting the hot roll and the thermistor cable is firmly seated in connector J7 on the engine board (E320/E322) or J14 on controller card (E220/E321/E323).</p> <p>Check for excessive toner buildup on the surface of the thermistor. Clean as necessary.</p> <p>With the printer unplugged, disconnect the thermistor cable from J7 (engine board in E320/E322) or J14 (controller card in E220/E321/E323).</p> <p>Measure the resistance of the thermistor. The resistance measures approximately 1K ohms immediately after printing or POR to approximately 240K ohms when thermistor reaches room temperature. (It may take 30 minutes to cool.)</p> <p>Replace the fuser assembly as necessary.</p>

Cooling fan service check (E320/E322)

FRU	Action
Cooling fan 	<p>Make sure the cooling fan motor cable plug is properly seated on the engine board.</p> <p>Unplug the printer and disconnect the cooling fan cable on the engine board.</p> <p>Restore printer power. Within approximately 3 seconds the engine board should apply +24 Volts direct current (V dc) to the fan. See “Connector locations ” on page 5-1 for more information.</p> <ul style="list-style-type: none"> • If voltage is present, replace the cooling fan. • If voltage is not present, see the “Engine board service check (E320/E322) ” on page 2-72 for more information.



Service checks involve measuring voltages of the LVPS, high voltage power supply (HVPS), and controller card assembly. Continuity and resistance verifications are done on cables and components as required.

Note: When looking at the printed side of a PCB, connectors are designated with “J” followed by a number. Pin 1 is designated on the PCB by an adjacent “1” or triangle. Pin numbers index sequentially to the opposite end of the connector. See **“RIP controller (E220/E321/E323 only) ” on page 5-8** for more information.

Cooling fan service check (E220/E321/E323)

FRU	Action
Cooling fan	<p>Make sure the cooling fan motor cable plug is properly seated.</p> <p>Turn the printer off and disconnect the cooling fan cable at J2 on the controller card.</p> <p>Turn the printer on. Within a few seconds the controller card assembly should apply +24 V dc to pin #1. See “RIP controller (E220/E321/E323 only)” on page 5-8 for more information.</p> <ul style="list-style-type: none"> • If voltage is present, replace the cooling fan first. If the fan still doesn't function, replace the controller card. <p>Note: The fan speed is controlled by a module on the PCB. Therefore, +24 V dc is constantly supplied at pin #1 (J2). Pin #2, the return, typically indicates varying voltages of less than +10 V dc in operation.</p> <ul style="list-style-type: none"> • If voltage is not present, see the “RIP controller (E220/E321/E323 only)” on page 5-8 for more information.

Controller card service check (E220/E321/E323)

FRU	Action
Controller card assembly	<p>Verify +5 V dc and +24 V dc inputs from the LVPS.</p> <ul style="list-style-type: none"> • Turn the printer off. • Disconnect the LVPS cable from the controller card at J1. See “Controller (E220/E321/E323 only)” on page 5-7 for more information. • Turn the printer on. <p>Verify +24 V dc from the cable, pins 3 and 4. Verify +5 V dc on cable pin 1.</p> <p>Verify that pins 2, 5 and 6 on both the cable and the card connectors are grounded.</p> <ul style="list-style-type: none"> • If voltages are correct, check the continuity in the cable. If the cable is good, see the “Low voltage power supply (LVPS) service check” on page 2-76 for more information. • If grounds are not correct on the cable, first check it for continuity and then the LVPS. • If the grounds are not correct on the controller card, replace the controller card. (Check with one probe on the connector pin and the other on the cards ground plane found at each screw head.)

FRU	Action
Controller card assembly (continued)	<p>Note: With all cables connected, the printer should complete POST within approximately 12–15 seconds in the following sequence:</p> <ol style="list-style-type: none"> 1. All operator panel lights on solid momentarily. 2. Lights then flash on and off sequentially. After lights quit flashing, the Ready/Data light turns on solid. 3. The cooling fan comes on. 4. The fuser lamp comes on. 5. The drive motor runs. 6. The printhead motor runs. 7. The printer cycles down into standby mode/ready. <p>If immediately following power-on the operator panel lights are active but the printer does not go through steps 1 and 2 above, replace the controller card assembly.</p> <p>Note: U.S. versus non-U.S. and the printer configuration ID can be reset. See “Printer diagnostics mode ” on page 3-40 for more information.</p> <p>If some lights are on or flashing, see “Status information light patterns ” on page 2-38 to determine a course of action.</p>

Cover interlock switch service check (E320/E322)

Note: Make sure a toner cartridge is installed and the cover closes all the way, engaging the cover open switch lever.

FRU	Action
Cover interlock switch 	<p>Disconnect the cover interlock cable plug from the engine board.</p> <p>Push the cover interlock switch to the closed position and check for continuity. See “Connector locations ” on page 5-1 for more information.</p> <p>If the switch does not close, replace the switch.</p> <p>Check for +24 V dc. If voltage is not present, see “Engine board service check (E320/E322) ” on page 2-72 for more information.</p>

Cover interlock switch service check (E220/E321/E323)

Note: Make sure a toner cartridge is installed and the cover closes all the way, engaging the cover open switch lever.



FRU	Action
Cover interlock switch	<p>Disconnect the cover interlock cable from the controller card at J6.</p> <p>Verify continuity between cable pin 1 and pin 2 with the door closed.</p> <p>Verify continuity between cable pin 1 and pin 3 with the door open.</p> <ul style="list-style-type: none"> • If either fail continuity, replace the cover interlock switch. • If both pass continuity, turn the printer on and verify +5 V dc on pin 2 at J6 on the card. • Verify pins 1 and 3 are ground. • If voltage or ground is not present, see “Controller card service check (E220/E321/E323)” on page 2-67 for more information. <p>Verify discontinuity between pins 2 and 3 whether the door is open or closed.</p> <p>Replace the cover interlock switch if faulty.</p>

Dead machine service check



CAUTION: Check the AC line voltage. The voltage should be within the following limits:

- 100 Volts alternating current (V ac)–127 V ac for the low voltage model printer
- 200 V ac–240 V ac for the high voltage model printer

FRU	Action
<p>Low voltage power supply fuse (LVPS)</p> 	<p>Unplug the printer and check the fuse on the LVPS board for continuity.</p> <ul style="list-style-type: none"> • If open, replace with appropriate fuse. <ul style="list-style-type: none"> – If fuse opens again, see “Low voltage power supply (LVPS) service check ” on page 2-76 for more information. • If not open, see power switch below.
<p>Power switch</p> 	<p>Restore power and turn on the printer power switch.</p> <p>Check for AC line voltage in the switch cable, CN1 (LVPS board), between pin 1 and ground and between pin 3 and ground.</p> <ul style="list-style-type: none"> • If line voltage is present, see the “Cover interlock switch service check (E320/E322) ” on page 2-69 or “Cover interlock switch service check (E220/E321/E323) ” on page 2-70 for more information. • If line voltage is not present on CN1, replace the power switch or check/correct missing line voltage.

Engine board service check (E320/E322)

FRU	Action
<p>Engine board</p> 	<p>Ensure +24 V dc from the LVPS board to the engine board.</p> <ol style="list-style-type: none"> 1. Turn off printer. 2. Disconnect the fuser lamp cable plug from the LVPS board. See “Connector locations” on page 5-1 for more information. 3. Disconnect the LVPS/engine board jumper cable from the engine board. See “Connector locations” on page 5-1 for more information. 4. Turn printer on. <ul style="list-style-type: none"> • If voltage is correct, ensure J12–power supply unit (PSU) is properly seated in the J12–PSU connector on the engine board. • Check for +24 V dc on the cable. • If voltages are not present or incorrect, see the “Low voltage power supply (LVPS) service check” on page 2-76 for more information. <p>Note: With all cables connected, the printer should complete POST within approximately 12–15 seconds in the following sequence:</p>

FRU	Action
Engine board (continued)	<ol style="list-style-type: none"> 1. All operator panel lights turn on solid. 2. All operator panel lights turn off. 3. Lights then sequence on and off one at a time starting with the Press Button light. <p>After 2 complete light sequences, the Ready light turns on solid.</p> <ol style="list-style-type: none"> 4. The cooling fan comes on. 5. The fuser lamp comes on. 6. The drive motor runs. 7. The printhead motor runs. 8. The printer cycles down into standby mode/ready. <p>If the operator panel lights come on solid and never turn off, replace the controller card and/or controller cable.</p> <p>If some lights are on or flashing, see the “Status information ” on page 2-3 to determine a course of action and/or replace the engine board.</p>

Fuser service check

When toner is partially fused to the paper, it is usually caused by low fuser temperature.

Warning: Avoid handling the lamp as much as possible as it is easily broken. Be careful not to touch the glass housing with bare hands as skin contains acids that can weaken the glass.

The line voltage to the printer must be within the following limits:

- 100 V ac–127 V ac for the low voltage model printer
- 200 V ac–240 V ac for the high voltage model printer

Turn the printer off and wait a few minutes for the fuser lamp to cool. Turn the machine on and observe the lamp turning on during POST.



You can see the lamp with the left side cover and fuser wire cover removed.

FRU	Action
<p>Fuser lamp Lamp cable LVPS</p> 	<p>Unplug the printer and disconnect the fuser lamp cable plug from the LVPS board connector CN2.</p> <p>Check for continuity across the fuser lamp pins 1 and 2.</p> <p>If there is continuity, go to Step 1: Continuity.</p> <p>If there is no continuity, go to Step 2: No Continuity.</p> <p>Step 1: Continuity</p> <p>Measure the voltage at connector CN2 on the LVPS. It should match the line voltage.</p> <ul style="list-style-type: none"> If line voltage is not present, see “Low voltage power supply (LVPS) service check ” on page 2-76 for more information. <p>Make sure the fuser thermistor is correctly connected to the engine board. If the problem persists, disconnect the thermistor cable at J7 (engine board in E320/E322) or J14 (controller card in E220/E321/E323) and check for less than +5 V dc on pin 1. Pin 2 should be ground. See “Engine board (E320/E322 only) ” on page 5-2 or page 5-7 for more information.</p> <ul style="list-style-type: none"> If the voltage is incorrect, see “Engine board service check (E320/E322) ” on page 2-72 or “Controller card service check (E220/E321/E323) ” on page 2-67 for more information. <p>Step 2: No Continuity</p> <p>Check the lamp cable for continuity.</p> <ul style="list-style-type: none"> If correct, replace the lamp. If incorrect, replace the lamp cable.

Hot fuser service check

Make sure the correct voltage lamp is installed. The voltage rating is stamped on one of the lamp contacts.

FRU	Action
Fuser 	<p>Disconnect the thermistor cable from J7 (engine board in E320/E322) or J14 and J22 (if used) (controller card in E220/E321/E323).</p> <p>Measure the resistance across the thermistor cable. See “Connector locations” on page 5-1 for more information. Replace the fuser assembly if the resistance is lower than 1k ohm or shorted.</p> <p>Note: Resistance measures approximately 240K ohms when cool and 1.4K ohms hot.</p>

Low voltage power supply (LVPS) service check

FRU	Action
Low voltage power supply board (LVPS) 	<p>Set meter for AC line voltage.</p> <p>Check for AC line voltage on CN1 between pins 1, and 3.</p> <ul style="list-style-type: none"> • If line voltage is present, disconnect the CN3 cable plug from the LVPS board. • If the voltage is not present, replace the power switch or check/correct missing line voltage. <p>Use the LVPS connector table (page 5-1) and check for correct voltages.</p> <p>If voltage is not present or correct, replace the LVPS fuses and/or the LVPS board.</p>

Main motor service check

FRU	Action
<p>Engine board (E320/E322) Main motor Main motor cable LVPS Controller card (E220/E321/E323)</p> 	<p>Verify +24 V dc at J5, pin 1 (engine board on E320/E322) or J8, pin 7 (controller card in E220/E321/E323). See “Engine board (E320/E322 only)” on page 5-2 and page 5-7 for more information.</p> <ul style="list-style-type: none"> • If these voltages are correct, check the main motor cable for continuity. • If continuity exists on each wire, replace the main motor. • If continuity does not exist on one or more of the wires, replace the motor cable. • If these voltages are not correct, see the “Low voltage power supply (LVPS) service check ” on page 2-76 or replace the engine board (E320/E322) or controller card (E220/E321/E323).

Operator panel button service check

FRU	Action
Operator panel Operator panel cable	<p>Open controller card cage and locate the connection for the operator panel (J2 for E320/E322 or J18 for E220/E321/E323).</p> <p>Check for continuity between pins 1 and 2 as you press the button (or Continue button E220/E321/E323).</p> <p>Similarly, check the continuity between pins 1 and 6 while pressing Cancel (E220/E321/E323).</p> <ul style="list-style-type: none"> • If continuity is not present, replace the operator panel. <p>Note: Check margin alignments after replacing the operator panel assembly. See “Printhead assembly ” on page 4-2 (steps 1through 11) for more information. If margin errors are unacceptable, corrections can only be made through software. Contact the next level of support or Lexmark at 1–800–539–6275.</p>

Operator panel service check

Inspect the operator panel cable for damage. Make sure the cable is plugged in securely.

Run POST and check each light for proper operation.

Warning: *Do not* replace the operator panel and controller card at the same time. Each card contains the printer settings. When either of these cards is new, it obtains the settings from the other card. Settings are lost when both are new at the same time.

FRU	Action
Operator panel Controller card	<p>If none of the lights come on, make sure the cable is properly connected to the controller card.</p> <ul style="list-style-type: none"> • Check for +5 V dc at J2, pin 5 (E320/E322) or J18, pin 5 (E220/E321/E323). See “RIP controller (E320/E322 only)” on page 5-6 or page 5-7 for more information. • If these voltages are not correct, replace the controller card. • If these voltages are correct, replace the operator panel. <p>If more than one light does not turn on or an individual light stays on solid during POST, replace the operator panel.</p> <p>Verify that the button(s) function correctly. Check continuity between pins 1 and 2 at the operator panel card and cable connector while pressing the button (or Continue E220/E321/E323).</p> <p>Similarly, check continuity between pins 1 and 6 while pressing Cancel (E220/E321/E323).</p> <ul style="list-style-type: none"> • If continuity is not present, replace the operator panel. <p>If all lights are dim and operate erratically during POST or all lights come on and stay on solid during POST, replace the following field replaceable unit (FRUs) one at a time in the order shown:</p> <ul style="list-style-type: none"> • Controller card • Operator panel

Paper feed service checks

Paper jam error indication during POST

FRU	Action
Exit sensor flag	If the exit sensor flag is not resting within the paper exit sensor during POST, the printer displays a paper jam message. Make sure the flag is operating freely and correctly installed.
Input paper feed sensor (registration sensor)	Make sure the input paper feed sensor is working properly. A stuck or incorrectly installed sensor causes this error.

Paper picks during POST and/or continuously

FRU	Action
Paper feed clutch assembly	<p>Check the pick roller clutch for wear. The solenoid interacts with the clutch controlling motion of the pick roller.</p> <p>If the cam surface of the pick roller clutch assembly is worn, the solenoid may not stop the pick roller from rotating. Replace the paper feed clutch assembly if necessary.</p> <p>Make sure the spring on the solenoid is properly installed. If the spring is improperly installed or missing, the pick roller will continuously pick paper.</p>

Paper picks but stops about an inch down the page

FRU	Action
D-roll assembly Registration roll assembly	<p>Check for obstructions.</p> <p>Check for wear on the rubber on the D-roll.</p> <p>Inspect the registration roll to ensure all springs, bearings and shafts are operational.</p>

Paper picks but stops half way through the printer

FRU	Action
<p>Input paper feed sensor Engine board (E320/E322) Controller card (E220/E321/E323)</p> 	<p>Make sure the input paper feed sensor is working properly.</p> <p>Check for a broken or stuck flag on the input paper feed sensor.</p> <p>Make sure the cable is seated on the engine board at J2 (E320/E322) or controller card at J11 (E220/E321/E323). See “Engine board (E320/E322 only)” on page 5-2 or page 5-6 for more information.</p> <p>Check for approximately +5 V dc on pins 2, 3, 5, and 6 (at J2 on the engine board of E320/E322 or J11 on controller card of E220/E321/E323).</p> <ul style="list-style-type: none"> • If correct, replace the input paper feed sensor. • If these voltages are not correct, replace the engine board (E320/E322) or controller card (E220/E321/E323).

Paper never picks

FRU	Action
Sheet feed assembly	Make sure the paper tray is correctly installed. The mylar guide sheet in the front of the tray must be positioned in the paper path just behind the pick roller assembly. This guide sheet can easily block the paper path if installed incorrectly.
Paper feed clutch assembly Engine board Controller card 	Unplug the printer, make sure the solenoid is installed correctly and its cable is plugged into J10 (engine board in E320/E322) or J12 (controller card in E220/E321/E323). See “Engine board (E320/E322 only)” on page 5-2 or page 5-6 for more information. <ul style="list-style-type: none"> • If the solenoid is properly plugged in, unplug unit and check resistance. • If the resistance is not 60–75 ohms, replace the solenoid. • If the resistance measures 60–75 ohms, see the “Engine board service check (E320/E322)” on page 2-72 or “Controller card service check (E220/E321/E323)” on page 2-67 for more information. Replace the engine board or controller card as necessary.

Paper occasionally picks or picks multiple sheets at once

FRU	Action
Pick roller assembly (D-roll)	Check pick roller (D-roll) assembly for wear. Replace as necessary.
Sheet feed assembly	Check the friction pad in the sheet feed assembly for signs of wear. Replace the sheet feed assembly as necessary.

Paper “trees,” wrinkles, stacks poorly or curls

FRU	Action
Fuser backup roll	This problem is most likely due to a worn backup roll. A worn backup roll causes the printer to run hotter than required for the media being printed. Excessive heat can cause paper treeing problems, poor stacking, or curl.

Paper skews or jams at registration roll

FRU	Action
Registration roll assembly Lower registration roll Registration roll bushings	<p>The registration roll contains a spring-loaded paper “stop” that deflects and aligns the paper as it is fed.</p> <ul style="list-style-type: none"> • Verify that the “stop” pivots freely and the springs fully return it after the paper passes. • Verify the rolls are in good condition and clean. • Replace unit(s) as necessary.

Parallel port service check

1. Perform a print test to make sure the printer prints correctly. See **“Ready ” on page 2-3** or **page 2-36** for more information.
2. Be sure the printer cable is designed for bidirectional printing.
3. Be sure the user Program is set up correctly.
4. For E320/E322, try enabling the parallel port pull-up resistors. See **“Parallel protocol ” on page 3-25**. Try printing a test page after enabling resistors. If the printer still does not print, disable the resistors. E220/E321/E323 printers do not support Mode 1; pull-up resistors are enabled.
5. If the internal print test page prints correctly, the user Program/printer driver is set up correctly and the correct bidirectional parallel cable is installed, but the printer still fails to print on command from the host computer, replace the controller card.

Print quality service checks

Note: Ensure cover is closed tightly. A gap in the opening may allow light to expose the photoconductor resulting in a 'dirty' print.

Blank page

FRU	Action
Toner cartridge	Remove the toner cartridge and gently shake it to evenly distribute the toner. Check for cartridge damage.
Printhead Printhead cable HVPS board LVPS board Engine board (E320/E322) Controller card (E220/E321/E323) 	Blank pages can be caused by a defective printhead assembly, HVPS, LVPS, engine board (E320/E322) or controller card (E220/E321/E323). <ul style="list-style-type: none"> • Printhead errors typically result in printer service errors. • Blank pages typically are caused by the PC roll not being properly charged. Unplug the printer and check continuity between the HVPS solder pads marked DC (below fan) and the corresponding pin inside the printer. <ul style="list-style-type: none"> • If there is not continuity, remove the HVPS and clean/replace springs. Try a different cartridge. If it fails, replace the HVPS.

Black page

Note: Incorrect laser exposure or incorrect charging of the photoconductor causes an all black page.

FRU	Action
HVPS contacts	<p>Check the contacts for contamination or incorrect installation.</p> <p>Check continuity between solder points on the outside of the HVPS to the contact tips at the print cartridge.</p> <p>With the print cartridge in the printer, check continuity from the solder pads marked "C" (adjacent to fan) to the clip inside the PC shutter. Then check continuity from the left bearing to the right bearing of the charge roll.</p> <p>Replace the contacts or charge roll assembly as necessary.</p>
Engine board LVPS board Controller card HVPS cable HVPS 	<p>Make sure the cable from the HVPS to the engine or controller card is correctly installed.</p> <p>See "Engine board (E320/E322 only)" on page 5-2 or "Controller (E220/E321/E323 only)" on page 5-7 and check the voltage measurements at J1 or J3 respectively.</p> <ul style="list-style-type: none"> • If the voltages are correct, check the HVPS to engine/LVPS cable for continuity. • If the cable does not measure continuity, replace the cable. • If the cable measures continuity, replace the HVPS. • If the voltages are not correct, see "Low voltage power supply (LVPS) service check" on page 2-76 and "Engine board service check (E320/E322)" on page 2-72 or "Controller card service check (E220/E321/E323)" on page 2-67.

Heavy background

Poor development or poorly charged toner particles cause excessive background. This is more noticeable as the toner cartridge nears end-of-life.

FRU	Action
Toner cartridge (not a FRU)	<p>Make sure the toner cartridge is correctly installed and the high voltage contacts are clean.</p> <p>If the cartridge is installed correctly, try a new cartridge.</p>
HVPS contacts HVPS board Engine board Controller card 	<p>Check the contacts for correct installation and contamination where contact is made with the toner cartridge and HVPS board. Clean as necessary.</p> <p>If this does not correct the problem, replace the following FRUs one at a time in the order shown:</p> <ul style="list-style-type: none"> • HVPS board • Engine board (E220/E321/E322) or • Controller card (E220/E321/E323)

Partial blank image/white spots (no periodic pattern)

FRU	Action
Toner cartridge (not a FRU)	Remove the toner cartridge and gently shake the assembly to evenly distribute the toner. If toner cartridge is low, try a new one.
Fuser backup roll bearings (and springs)	Check left and right backup roller springs and backup roller to ensure adequate even pressure is applied to the fuser hot roll.
Paper (not a FRU)	Make sure recommended paper is being used.

Variation in image density horizontally across page

FRU	Action
Toner cartridge (not a FRU)	The charge roll may have an unbalanced pressure against the photoconductor (PC) drum. Open the cover about two inches and observe the charge roll against the PC. It should be free from binds and resting against the PC. Try a new toner cartridge.
Transfer bearing Transfer roll	Check the springs in the left and right transfer roll bearings. The bearing assemblies should support the transfer roll, applying even pressure to the PC drum. Replace either or both transfer roll bearing assemblies if the springs show signs of damage or fatigue. Inspect the transfer roll for signs of wear, damage or contamination. Replace as necessary.

Poor fusing of image

FRU	Action
Fuser lamp	The fuser may not be operating at the proper temperature to fuse the toner to the paper. See “Hot fuser service check ” on page 2-76.
Paper (not a FRU)	Make sure recommended paper is being used.

Light print

FRU	Action
Toner cartridge (not a FRU)	<p>Make sure the toner cartridge is installed correctly and is not low on toner.</p> <p>If the problem continues, install a new toner cartridge.</p>
Transfer roll HVPS contact (transfer roll) HVPS board	<p>Check the transfer roll for signs of toner buildup and contamination.</p> <p>Inspect the HVPS contact (transfer roll) for contamination.</p> <p>Inspect the HVPS board for contamination where it meets the HVPS contacts.</p> <p>If all components appear free of contamination, replace the following FRUs one at a time in the order shown:</p> <ul style="list-style-type: none"> • Transfer roll • HVPS contact (transfer roll) • HVPS board

White or black lines or bands

FRU	Action
Toner cartridge (not a FRU) Drive gear assembly	<p>Banding appears as light or dark horizontal lines on a uniformly gray page or on a page with a large area of graphics. Banding is primarily due to a variation in the speed of the paper as it feeds through the printer especially in the developer and transfer process. Inspect the toner cartridge and paper feed components, especially the drive gears, for signs of wear, debris, binds, or damage.</p> <p>Replace the drive gear assembly as necessary.</p>

Toner on back of page

FRU	Action
Print cartridge (not a FRU)	<p>Inspect the overall paper path for signs of spilled toner.</p> <p>Gently clean the contaminated areas with a soft cloth or compressed air.</p>
Fuser hot roll Backup roll	<p>The fuser hot roll can cause toner on the back of the paper if toner is building up on the hot roll. This buildup may transfer to the backup roll, later transferring to the back of the paper.</p> <p>Inspect the hot roll and backup roller for signs of contamination and replace as necessary.</p>
Transfer roll	<p>A transfer roll contaminated with toner can cause toner to transfer to the back of printed pages.</p> <p>Inspect the transfer roll for contamination and replace as necessary.</p>

Solving print quality problems

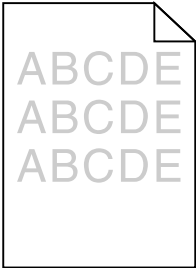
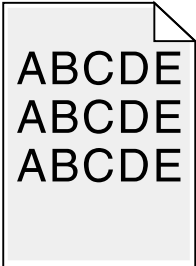
Problem	Action
<p>Light or blurred characters.</p> 	<p>The print cartridge may be getting low on toner:</p> <ul style="list-style-type: none"> • Remove the print cartridge. • Shake it from side to side to redistribute the toner. • Reinstall it. • For E320/E322 models only, run engine clean cycle to remove any toner that may have accumulated. See “Execute engine clean cycle” on page 3-13 (E320/E322 only) for more information. • Make sure you are using recommended print media (see media types and sizes in the <i>User's Reference</i>.) • Use MarkVision to define the custom type setting for media type, media texture, or media weight. • The print cartridge may be defective. Replace it.
<p>Toner smudges appear on the front or back of the page.</p> 	<ul style="list-style-type: none"> • For E320/E322 models only, run engine clean cycle to remove any toner that may have accumulated. See “Execute engine clean cycle” on page 3-13 for more information. • Make sure the paper is straight and unwrinkled. • Replace the print cartridge.

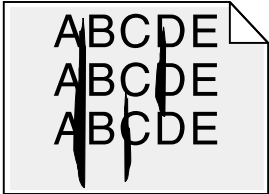
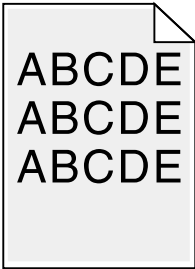
Problem	Action
<p>Vertical or horizontal streaks appear on the page.</p> 	<p>For E320/E322 models only, run engine clean cycle to remove any toner that may have accumulated. See “Execute engine clean cycle” on page 3-13 (E320/E322) for more information.</p> <p>Replace the print cartridge.</p>
<p>Toner smears or rubs off the page.</p> 	<ul style="list-style-type: none"> • For E320/E322 models only, run engine clean cycle to remove any toner that may have accumulated. See “Execute engine clean cycle” on page 3-13 for more information. • Check fuser temperature. Replace if necessary. • Try a different kind of paper. Paper designed for copiers gives the best quality. • If you are printing on special media, such as card stock or labels, be sure you select the correct paper type in the printer driver. • Change the media texture setting. If the setting is not in your driver, you can download the correct Lexmark setup utility from the Lexmark Web site at www.lexmark.com.
<p>The print is getting light but the Toner Low light is not on.</p>	<ul style="list-style-type: none"> • The Toner Low light does not come on if the standard 1,500 page print cartridge is installed. • Remove the print cartridge and gently shake it from side to side to redistribute the toner. • Replace the print cartridge.

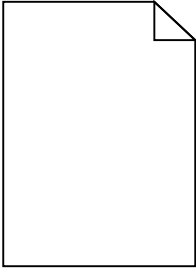
Problem	Action
The Toner Low light is on.	<ul style="list-style-type: none"> • Remove the print cartridge and gently shake it from side to side to redistribute the toner. • Replace the print cartridge.
Solid black areas on transparencies or white streaks on paper.	<ul style="list-style-type: none"> • Choose a different fill pattern in your software Program. • Try a different type of paper. Paper designed for copiers gives the best quality. • Remove the print cartridge and gently shake it from side to side to redistribute the toner. • Replace the print cartridge.
Faint images or repetitive spots appear on the page.	<ul style="list-style-type: none"> • Select a different media type or form type setting from your printer driver. • Try a different type of paper. Paper designed for copiers gives the best quality. • Replace the print cartridge.
Pages are blank. 	<ul style="list-style-type: none"> • The print cartridge may be out of toner or defective. Replace the cartridge. • You may have a software error. Try turning the printer off and back on.
The operator panel lights do not come on when the printer is turned on.	<ul style="list-style-type: none"> • The lights may take a few seconds to come on. • Make sure the power cord is firmly plugged in at the back of the printer and at the electrical outlet.
The top cover does not close.	Make sure the print cartridge is positioned correctly.

Problem	Action
The printer is on, but nothing prints.	<ul style="list-style-type: none"> • Make sure the print cartridge is installed properly. • Make sure the parallel or USB cable is not damaged and is firmly plugged into the connector on the back of the printer. • Press and release Continue to print a menu settings page to determine whether the problem is with the printer or the computer. <ul style="list-style-type: none"> – If you can print a menu settings page, the problem is in the computer, the software Programs or the cable. – If you cannot print a menu settings page, call the next level of support.
Toner Low light is on and printing stops.	<p>If you are using a 3K or 6K print cartridge and the Toner Low alarm is set to on, the printer stops printing until you replace the print cartridge.</p> <ul style="list-style-type: none"> – Download the correct Lexmark setup utility from the Lexmark Web site at www.lexmark.com to change the Toner Low alarm.
The Error light is on.	Make sure the printer cover is closed.
The Toner Low light is blinking, and the Error light is on.	<ul style="list-style-type: none"> • Make sure the print cartridge is installed correctly. • Install a new print cartridge.
The media skews or buckles.	<ul style="list-style-type: none"> • Don't overfill Tray 1 or the optional Tray 2 (see media capacities in the media types and sizes table in the <i>User's Reference</i>). • Make sure the paper guides are flush against the edges of the media.

Problem	Action
The paper sticks together/printer feeds multiple sheets of paper.	<ul style="list-style-type: none">• Remove the paper from Tray 1 or the optional Tray 2 and fan the paper.• Don't overfill Tray 1 or the optional Tray 2 (see media capacities in the media types and sizes chart in the <i>User's Reference</i>).
The paper fails to feed from Tray 1.	<ul style="list-style-type: none">• Remove the paper from Tray 1 and fan the paper.• Make sure Tray 1 is selected from the printer driver.• Do not overfill the tray.• Check the rubber on the D-roll assembly (pick roll).

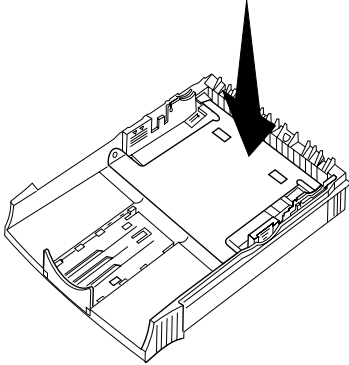
Problem	Action
<p>The paper fails to feed from the optional Tray 2.</p>	<ul style="list-style-type: none"> • Make sure the optional Tray 2 is selected from the printer driver. • Make sure the tray is pushed all the way in. • Make sure the metal plate is pressed down before inserting it into the printer.  <p>Note: Once the tray is inserted, the metal plate springs up so the paper can feed into the printer.</p> <ul style="list-style-type: none"> • Make sure the paper does not exceed the stack height indicator. • Make sure the paper is under both corner bucklers (see loading paper in the <i>User's Reference</i>). • Remove the paper from the optional Tray 2 and fan the paper. • Check the rubber on the D-roll assembly (pick roll).
<p>The Load Paper light is on even though there is paper loaded in the optional Tray 2.</p>	<ul style="list-style-type: none"> • Make sure the tray is pushed all the way in. • Press Continue.
<p>The printer does not print after a paper jam has been cleared.</p>	<ul style="list-style-type: none"> • Clear all jams. • Press and release Continue or open and close the printer cover to restart the printer. • Make sure the print cartridge is installed properly.

Problem	Action
Unexpected characters print or characters are missing.	<ul style="list-style-type: none"> • Ensure correct printer driver is being used. • Press and hold Continue until all lights come on to reset printer to user default settings. • Select hex trace mode to determine what the problem is. • Restore factory defaults. • Make sure the parallel cable or USB cable is firmly plugged in at the back of the printer.
Jobs are not printing and the Error light is on solid.	<ul style="list-style-type: none"> • Make sure the print cartridge is installed properly. • Make sure the printer top cover is closed.
While in PostScript® 3 emulation, the printer is flushing data (Ready/Data and Error lights are blinking).	<ul style="list-style-type: none"> • Ensure the correct PostScript driver is being used. • The Lexmark E220, E320, and E321 do not support PostScript emulation. • The printer doesn't have enough memory to print the job. Install more memory.
Manual duplex isn't on the printer.	The printer driver may not support manual duplex. Go to the Lexmark Web site at www.lexmark.com to download the latest printer driver.
While using manual duplex, the printer gets a paper jam.	<p>A paper jam interrupts the duplex process. As a result, the information on the page that jammed is lost.</p> <ul style="list-style-type: none"> • Press and release Cancel to cancel the print job. • Press and hold Cancel (approximately 3 seconds) to reset the printer. • Resend the print job.

Transfer roll service check

FRU	Action
Transfer bearing Transfer roll	<p>Check transfer roll area for debris and clean as necessary.</p> <p>Unplug the printer and check for continuity between the T solder joints (lower right side of the HVPS) and the right side of the transfer roll shaft.</p> <ul style="list-style-type: none">• If continuity is not indicated, remove the left bearing and check continuity between the solder joint and spring loaded pin.<ul style="list-style-type: none">– If continuity fails, replace the HVPS contacts.– Clean bearing or replace if necessary.• If continuity is confirmed, check the bearing springs at each end of the transfer roll. They should provide even forces.<ul style="list-style-type: none">– Replace bearings if necessary.– Inspect the roll for signs of wear or damage and replace if necessary.

Resetting user defaults (E320/E322)

When formatting problems occur or unexpected characters print, try resetting the printer default settings to your user defaults. Press and hold the operator panel button until all the lights come on.

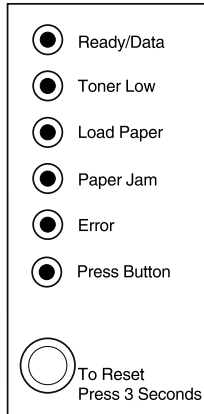

Restoring factory defaults (E320/E322)

Sometimes resetting the printer to the original factory default settings solves formatting problems.

1. Enter the special function menu. See “**Using the special function menu (E320/E322)**” on page 2-105 for more information.
2. Press and release the operator panel button twice quickly until the Toner Low light comes on and the two bottom lights blink.
3. Press the operator panel button with a long button press (hold until all the lights come on) to reset the printer to the original factory defaults.

Once the settings are returned to the factory default values, the printer returns to the **Ready** state.

Restoring factory defaults (E220/E321/E323)

1. Enter the configuration mode. See “**Using the special function menu (E220/E321/E323)**” on page 2-106 for more information.
2. After the four top lights are on, press and release **Cancel**.
3. Press and hold **Continue** until lights flash. The factory defaults are reset.
4. To return the printer online, POR the printer.

Using Hex Trace mode (E320/E322)

When unexpected characters print or characters are missing, use Hex Trace to help determine if there is a problem with the language interpreter or the cable. Hex Trace isolates printing problems by indicating what information your printer is receiving.

1. Enter the special function menu. See **“Using the special function menu (E320/E322)” on page 2-105** for more information.
2. Press and release the operator panel button twice quickly (double button press) three times until the Paper Jam light comes on and the two bottom lights blink.
3. Press the button with a long button press (hold until all the lights come on) to select the Hex Trace setting.
4. Press the button with another long button press to initiate Hex Trace.

Data sent to the printer is printed out in hexadecimal and character representation to help isolate the source of the problem.

To exit Hex Trace mode, turn off the printer or press the operator panel button with a long button press.

Using Hex Trace mode (E220/E321/E323)

1. Turn the printer on with the door open and **Continue** pressed.
2. Close the door after the lights quit flashing.
3. Press and hold **Continue** until the lights flash. A menu is printed. Follow the instructions on the menu to set the Hex Trace on. See the following for more information:
 - **“Using the special function menu (E220/E321/E323)” on page 2-106** or
 - **“Configuration menu group or diagnostic menu group” on page 3-36**
 - **“Changing settings or printing graphical aids” on page 3-37**

Using print quality test pages (E320/E322)

To help isolate print quality problems, like streaking, print test pages using the print quality test pages setting:

1. Enter the special function menu. See “**Using the special function menu (E320/E322)**” on page 2-105 for more information.
2. Press and release the operator panel button twice quickly (double-button press) four times until the Ready/Data and Toner Low lights come on and the bottom two lights blink.
3. Press the operator panel button with a long button press (hold until all the lights come on) to initiate print quality test pages.

Three pages print to help evaluate print quality. The first page has registration marks, the second page is gray, and the third page is black. Once the paper exits into the output bin, the printer returns to the **Ready** state.

4. Use the test pages to isolate problems such as light print or toner streaks. See the Troubleshooting tables for solutions to these problems.
5. To exit print quality test pages, press the operator panel button with a long button press (hold until all the lights come on).

Using print quality test pages (E220/E321/E323)

To help isolate print quality problems, like streaking, print test pages using the print quality test pages setting:

1. Enter the configuration menu. See **“Using the special function menu (E220/E321/E323)” on page 2-106** for more information.
2. Slowly press and release **Cancel** three times until the Ready/Data and Toner Low lights come on and the bottom lights are off.
3. Press and hold **Continue** until all lights flash to initiate print quality test pages.

Three pages print to help evaluate print quality. The first page has various fonts, the second page is gray, and the third page is black. Once the paper exits into the output bin, the printer returns to the home state (four top lights on).

4. Use the test pages to isolate problems such as light or toner streaks. See the Troubleshooting tables for solutions to these problems.
5. To exit print quality test pages, turn the printer off.

Using the special function menu (E320/E322)

Printer settings for solving print quality problems are in the special function menu: restore factory defaults, Hex Trace, print quality test pages, and advanced troubleshooting mode.

To enter the special function menu:

1. Turn off the printer.
2. Open the top cover.
3. Turn the printer back on.
4. When the Error light comes on, indicating the top cover is open, press and release the operator panel button twice quickly.
5. When the Error light and Press Button light blink, close the cover.

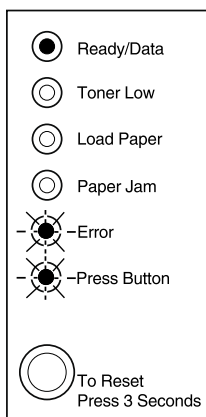

The special function menu is activated.

Using the special function menu (E220/E321/E323)

To access the printer settings, special functions, and diagnostics:

1. Turn the printer off.
Press and hold the buttons in the following table for the operation needed.
2. Turn the printer on.
3. Press and hold the buttons until the lights cycle on the operator panel.

Operation	Power-on action
Enter configuration menu mode	<ul style="list-style-type: none"> • Power on with top cover open and Continue pressed. • Close cover once the Error light is displayed.
Print the print quality test pages	<p>Top cover open with Continue pressed. (Cartridge lockout function enabled).</p> <ul style="list-style-type: none"> • Power on with top cover open and Continue pressed. • Close cover once the Error light is displayed. • With the top four lights on solid, press and hold Continue until lights blink.
Enter diagnostics mode	<ul style="list-style-type: none"> • Power on with top cover open and Cancel pressed. • Close cover once the Error light is displayed.
Print the print quality test pages	<p>Top cover open with Cancel pressed. (Cartridge lockout function disabled).</p> <ul style="list-style-type: none"> • Power on with top cover open and Continue pressed. • Close cover once the Error light is displayed. • With the top four lights on solid, press and hold Continue until lights blink.
Reset NVRAM and enter normal mode	<ul style="list-style-type: none"> • Power on with top cover open and both Continue and Cancel buttons pressed. • Close cover once the Error light is displayed.

4. In the configuration or diagnostics mode (four top lights on), press and hold **Continue** to print instructions and a map of possible settings and functions. Menu items are above the dotted line, while settings are below the dotted line. Follow the instructions to make the desired changes or enter special function.

3. Diagnostic aids

Note: For information about models E220/E321/E323 see
“**Diagnostic aids (E220/E321/E323)**” on page 3-35.

Diagnostic aids (320/E322)

This chapter describes procedures you can use to identify printer failures and verify that repairs have corrected the problem.

Performing self test

At power-up, each light turns on and off in reverse sequence, starting with Press Button and ending with Ready. Each light remains on for approximately one second, but no more than approximately two seconds. This cycling repeats as needed during the execution of the self test. The printer performs the cycle at least once. Additional cycles can be interrupted at any point in the cycle indicating the self test is complete.

Information priority

The priority for displaying information on the operator panel is:

1. Service information
2. Top cover open
3. All other information in the order of occurrence

Printer operation modes

The printer supports six distinct modes of operation. Each of the following operations may only be performed if the printer is in the correct operation mode.

The six modes are:

- Normal printing
- Demo printing
- Diagnostics tests
- Special function menu
- Configuration
- Hex Trace

The mode entry table lists steps to enter and exit each mode. See **“Printer modes summary table” on page 3-3** for details.

Printer modes summary table

Mode	Method of entry	Method of exit
<p>Normal printing</p>	<p>NVRAM power–on default flag set to Normal</p> <p>AND</p> <p>Turn on printer with cover closed.</p> <p>OR</p> <p>Print engine cleaning cycle page from special function menu.</p> <p>OR</p> <p>Operator panel reset from hex trace.</p> <p>OR</p> <p>Print quality test page from special function menu.</p> <p>OR</p> <p>Reset defaults from special function menu.</p>	<p>Turn off printer and follow instructions for method of entry.</p>

Mode	Method of entry	Method of exit
Demo printing	<p>NVRAM power-on default flag set to Demo</p> <p>AND</p> <p>Turn on printer with cover closed.</p> <p>OR</p> <p>Print engine cleaning cycle page from special function menu.</p> <p>OR</p> <p>Operator panel reset from hex trace.</p> <p>OR</p> <p>Print quality test page from special function menu.</p> <p>OR</p> <p>Reset defaults from special function menu.</p>	Turn off printer and follow instructions for method of entry.
Diagnostics tests	<p>Turn on printer while pressing the button with the top cover open.</p> <p>Once the printer posts the top cover open indication, close the top cover.</p>	Turn off printer and follow instructions for method of entry.

Mode	Method of entry	Method of exit
Special function menu	Turn on printer with the top cover open. Once the printer posts the top cover open indication, double press the button. When the lights start flashing, close the cover.	Execute the engine clean cycle, hex trace, print quality test pages, reset defaults or toggle demo mode function.
Configuration	Enter the special function menu mode and then select the enter configuration mode option.	Turn printer off and follow instructions for “method of entry” to enter desired mode.
Hex Trace	Enter the special function menu mode and then select the enter hex trace mode option.	Turn printer off.

Normal printing mode

1. Turn the printer on.
2. Verify the operator panel Ready light is on.

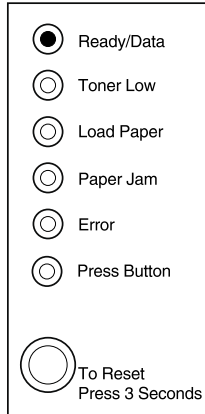

The printer is ready for normal operation.

Demo printing mode

This printer setting indicates whether or not demo mode is active. When demo mode is set to on, demo mode is entered each time the printer is turned on.

The printer posts the **Busy** indication on the operator panel. **Busy** is posted until the demo print job completes or until some asynchronous event occurs, for example, reset or intervention. When the demo job completes, the printer posts demo ready and remains in demo mode waiting for the initiation of another demo job.

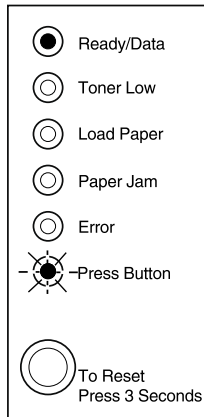

This is demo mode with the Press Button light flashing.

Printing menu settings page

A user can invoke the print test page function only under normal printing mode in the **Ready** state.

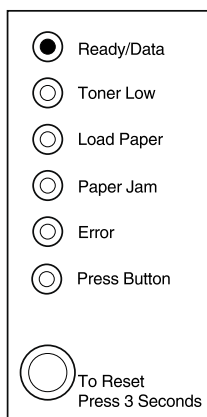

Briefly press the **Reset** button.

The menus page contains the following information:

- Listing of all printer settings contained in the operator panel menus, and their default values.
- Printer information such as serial number, page count, installed RAM, engine code level, controller code level, and font information.

Note: The menus page is printed in the language specified by the display language printer setting.

Diagnostic tests mode

The diagnostic tests mode causes the printers internal tests to be performed. If any of the diagnostic tests fail, a service indication is posted. You can determine which test failed by accessing the service code associated with the service error. The secondary service code is displayed by performing a button press while the service indication is posted on the operator panel.

If the printer completes all its diagnostic tests successfully, the Toner Low light blinks. To exit diagnostics, turn off the printer.

While running diagnostics, the printer performs the following tests:

- Standard memory test
- Optional memory test

When the printer enters Normal or Demo modes, the total amount of installed memory detected during the POST sequence is compared with an NVRAM value representing the printer total installed memory.

- If the amount of detected memory matches the value stored in NVRAM, the printer doesn't perform a Memory Test during POST sequence into Normal or Demo modes.
- If the amount of detected memory does not match the NVRAM value representing total installed memory, the printer assumes the user has changed the printers memory configuration by adding or removing optional memory.

To verify the new memory configuration, the printer performs a full Memory Test and then updates the NVRAM value representing the total installed memory.

Note: The printer always performs a complete Memory Test when executing the Diagnostics Test.

Entering diagnostic tests mode

1. Turn the printer off.
2. Open the printer cover.
3. Press and hold the operator panel button.
4. Turn the printer on.
5. When the cover open error is indicated on the operator panel (Error light on), release the button.
6. Close the cover.

The printer automatically runs the diagnostics test.

- If the test passes, the Toner Low light blinks.
- If a test fails, a service indication is displayed.

Once the diagnostics test is complete, a one page Quick Test can be printed by briefly pressing the operator panel button.

Special function menu

The special function menu lets the following functions be executed from the operator panel:

- Execute engine cleaning cycle
- Reset defaults
- Enter configuration mode
- Enter hex trace
- Print diagnostics/print quality test page
- Set demo mode active/inactive

Entering special function menu

1. Turn the printer off.
2. Open the printer cover.
3. Turn the printer on.
4. When the cover open error is indicated on the operator panel, (Error light on), double press the button.
5. When the Error and Press Button lights start flashing, close the cover.

The special function menu is now active.

Special function menu light summary table

Ready/ Data	Toner Low	Load Paper	Paper Jam	Error	Press Button	Condition
●	○	○	○	*	*	Execute engine clean cycle
○	●	○	○	*	*	Reset defaults
○	○	●	○	*	*	Enter config mode
○	○	○	●	*	*	Enter hex trace
●	●	○	○	*	*	Three print quality test pages
●	○	●	○	*	*	Toggle demo mode

- Single button press—not used.
- Long button press—executes the current menu selection. When the selection is executed, the lights change the state to indicate the function is executed.
- Double button press—moves to next selection in the menu (for example, from engine clean cycle to reset defaults).

Execute engine clean cycle

The execute engine clean cycle function prints one blank page in a special cleaning mode. Prior to executing the engine cleaning cycle, place one sheet of paper into the automatic paper feed slot. The cleaning mode helps eliminate small specs of toner present in the background when printing.

See the special function menu ([page 3-11](#)) and this action:

Perform a long button press until all lights are on solid. The printer feeds one sheet of paper.

Once the engine cleaning cycle pages are printed, the printer enters either normal printing or demo printing modes based on the NVRAM power-on default flag.

Reset defaults

The reset defaults function resets the printer settings to the factory defaults.

Configuration mode

The configuration mode allows the setting of certain printer functions through the operator panel that cannot be modified using the data stream.

The following settings may be modified or selected in configuration mode:

- Parallel port settings
 - Enable port
 - NPA mode
 - Protocol
 - Mode 1
 - Mode 2
 - Strobe adjust
- USB settings
 - Enable port
 - NPA mode
- PPDS activated
- Auto line feed carriage return (LFCR)/carriage return line feed (CRLF)

Auto line feed after a carrier return, auto carrier return after a line feed, and PPDS activated settings may be modified using printer job language (PJM). However, modifications of these settings are typically required by non PC users, so the Lexmark E32x utilities may not be used to modify these settings.

Operator panel definitions while in configuration mode:

Action	Definition
Double button press	Moves through the configuration mode menu items.
Brief button press	Moves through the displayed menu item value list.
Long button press	Selects and saves the value displayed for the menu item. To indicate to the user a setting has been saved, the printer displays the saving setting indication.

Entering configuration mode

Enter configuration mode by selecting the Enter Config Mode option on the special function menu.

The printer is in configuration mode when the Ready/Data light comes on, and the Toner Low, Load Paper, Paper Jam, Error lights are off. Press Button indicates the Par Enabled setting.

To exit configuration mode, turn off the printer.

Once the printer enters configuration mode, replace the words on the panel overlay with one of the following overlays.

Solid lights

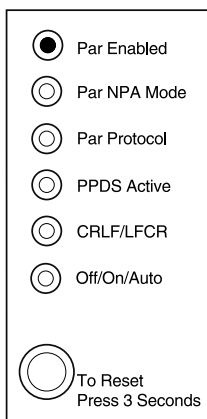

Blinking lights

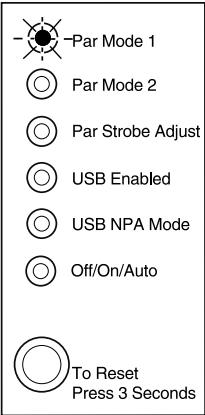

For the solid lights, the lit Par Enabled (Ready) light means the panel is presently showing the value for the menu item Parallel Port Enabled. The off/on/auto (Press Button) light displays the value of the current setting: off, on, or auto. (For this example, Parallel Port Enabled is off.) The value list for the menu item Parallel Enabled is off, on, and auto.

Brief button presses cause the printer to cycle through the various values within the value list for the menu item displayed. For Parallel Enabled – a brief button press causes the off/on/auto (Press Button) light to light.

Another brief press causes the off/on/auto (Press Button) light to blink.

Subsequent brief button presses cause the printer to cycle through the valid values for the displayed menu item. When the setting you want is displayed on the off/on/auto (Press Button) light, a long button press saves the displayed value. The printer indicates a setting is being saved by displaying all lights on solid.

4500–E320/E322

The following table shows which printer mode must be active for each operation.

Operation	Mode
Print buffer	Normal
Operator panel reset	Normal, Demo, and Hex Trace
Print test page	Normal
Print font samples	Normal
Print directory	Normal
Format flash	Normal
Set demo mode active/inactive	Special function menu
Print demo	Demo
Diagnostic tests	Diagnostic mode
Print quality test page/registration adjustment	Normal and special function menu
Factory defaults	Normal and special function menu
Hex Trace	Special function menu
Execute engine cleaning cycle	Special function menu
Parallel–enable port	Configuration “ Parallel port ” on page 3-23.
Parallel–NPA mode	Configuration “ Parallel NPA mode ” on page 3-24.
Parallel–protocol	Configuration “ Parallel protocol ” on page 3-25.
Parallel–mode 2	Configuration “ Parallel mode 2 ” on page 3-26.
Parallel–strobe adjust	Configuration “ Parallel strobe ” on page 3-27.
Activate/deactivate PPDS	Configuration “ Data streams ” on page 3-28.

Operation	Mode
Auto CRLF/LFCR	Configuration “ Carriage return line feed/line feed carriage return (CRLF/LFCR) ” on page 3-30.
USB–enable port	Configuration “ USB port ” on page 3-32.
USB–NPA mode	Configuration “ USB NPA mode ” on page 3-33.

Printer buffer

The print buffer operation is only available while the printer is operating in its normal mode and when the operator panel indicates the printer is waiting.

Operator panel reset

Perform a long button press—for example, press and hold the button until the printer posts the resetting printer indication (resetting printer is indicated when all the lights on the operator panel are on).

Print font samples

The print font samples operation is not accessible through the operator panel. Two PJI commands exist which let the user obtain samples of the stored fonts.

Print directory

Print directory is not supported by the operator panel. It is supported by issuing a PJI command.

Format flash

Format flash is not supported by the operator panel. It is supported by issuing a PJI command.

Set demo mode active/inactive

The power-on default for the printer may be switched between normal and demo by activating/deactivating demo mode toggle.

Go to the Special function menu ([page 3-11](#)) and perform the following:

1. Select Toggle Demo mode by double pressing the operator panel button until the Ready and Load Paper lights are on.
2. Perform a long button press until all lights are on solid.

Print registration adjustment

- Adjust the left margin until the registration box illustrated on the diagnostics test page is centered on the page.
- Adjust the top margin until the registration lines located at the bottom of the diamonds at the bottom of the page fall on the bottom edge of the page.

These settings may be modified by issuing PJL DEFAULT commands when the printer is in normal mode. The PJL variables used to describe registration are LLEFTMARGINOFFSET and LTOPMARGINOFFSET.

Factory defaults

When the printer is initialized, the printer environment returns to default settings.

There are of two types of default settings:

- Fixed default settings cannot be modified from their factory set values.
- Variable default settings can be altered from their factory set values. Factory set values are never erased and may be restored at a later time.

Restoring factory defaults

Restoring factory defaults returns the printer settings to the original factory settings.

Go to the Special function menu ([page 3-11](#)) and perform the following:

1. Select Reset Defaults mode by double pressing the operator panel button until the Toner Low light is on.
2. Perform a long button press until all lights are on solid.

The printer is reset to factory defaults.

Enter Hex Trace mode

When the printer is in hex trace mode, it prints a hexadecimal and a character representation of a print job. The printer does not recognize any print controls or commands in this mode. A hex trace printout can be used to help isolate the cause of print problems. This is done by checking the control codes embedded within a print job.

Go to the special function menu ([page 3-11](#)) and perform the following:

1. Select enter Hex Trace mode by double pressing the operator panel button until the Paper Jam light is on.
2. Perform a long button press until all lights are on solid.

The printer is reset to factory defaults.

Hex Trace mode can be exited by turning off the printer, or by pressing and holding the operator panel button to reset the printer.

Print quality test pages

Go to the Special function menu (**page 3-11**) and perform the following:

1. Select three print quality test pages mode by double pressing the operator panel button until the Ready/Data and Toner Low lights are on.
2. Perform a long button press until all lights are on solid.

When a test page is printed from the special function menu:

- The first diagnostic test page illustrates print registration marks which aid the user during the print registration adjustment process.

In addition, the first diagnostic test page also includes the current value of some user default settings.

Note: The diagnostics test page is printed in english only.

- The second page is gray.
- The third page is black.

Note:

- Both pages are used by service and manufacturing to evaluate print quality.
- Both diagnostic test pages can be printed from the print quality test pages function.

Once the print quality test pages are printed, the printer enters either normal printing or demo printing modes based on the NVRAM power-on default flag.

Parallel port

Parallel port lets the user enable or disable the parallel port. If the port is not being used, disabling it frees allocated memory to be used to process print jobs.

Note: Optional parallel ports are not available to change in some network models.

Perform the following steps to change the Parallel port setting:

1. Enter the configuration mode. See “**Configuration mode**” on **page 3-14** for more information.

The Parallel port (Ready) light comes on solid. The current Parallel port setting is indicated by the off/on/auto (Press Button) light. When the light is off, the parallel port is disabled. When the light is blinking, the parallel port is enabled.

2. Perform a brief button press to select the parallel port setting.
3. Perform a long button press. All lights blink once, indicating the setting is saved.
4. Exit the configuration mode by turning the printer power off.

Off/on/auto	Setting value
○	Parallel port is disabled. The printer doesn't receive data from the parallel port.
●	Parallel port is enabled with a fixed buffer size. The buffer size is set from a utility such as MarkVision. Note: This light state is only displayed if the current value for the Parallel port enabled setting is a fixed value. The user can't set the value by pressing the button to cycle from the off value to the on value, that is, the button press cycles from off to auto.
*	Parallel port is enabled with an automatic buffer size. The printer determines the buffer size based on available memory and other printer settings.

Parallel NPA mode

Parallel NPA mode allows two way communication between the host computer and the printer.

Perform the following steps to change the Parallel NPA setting:

1. Enter the configuration mode. See **“Configuration mode” on page 3-14** for more information.
2. Perform a double button press. This moves to the parallel NPA item on the configuration menu. The parallel NPA (Data) light comes on solid.
3. The current parallel NPA setting is indicated by the off/on/auto (Press Button) light.
 - When the light is on solid, all data received by the printer must be in NPA packets. Any non-packet data is rejected as bad packets.
 - When the light is off, the printer is not performing any NPA processing.
 - When the light is blinking, the printer examines incoming data and decides whether it is receiving NPA packets.
4. Perform a brief button press to select the parallel NPA setting.
5. Perform a long button press. All lights blink once, indicating the setting is saved.
6. Exit the configuration mode by turning the printer power off.

Off/on/auto	Setting value
○	The parallel port does not search for NPA data within the received data.
●	The parallel port requires that data sent to the printer be in NPA format.
*	The parallel port searches for optional NPA data within the received data.

Parallel protocol

The printer supports two parallel protocol settings: standard and fastbytes. When the protocol is set to standard, information is received at a normal transmission rate. When the protocol is set to fastbytes, information is received at a much faster transmission rate provided the host computer supports the fastbytes mode.

Perform the following steps to change the parallel protocol setting:

1. Enter the configuration mode. See **“Configuration mode” on page 3-14** for more information.
2. Perform a double button press two times. This moves to the parallel protocol item on the configuration menu. The parallel protocol (Load Paper) light comes on solid.
3. The current parallel protocol setting is indicated by the off/on/auto (Press Button) light. When the light is off, the parallel protocol is set to standard. When the light is on, the parallel protocol is set to fastbytes. Perform a brief button press to select the parallel protocol setting.
4. Perform a long button press. All lights blink once, indicating the setting is saved.
5. Exit the configuration mode by turning the printer power off.

Off/on/auto	Setting value
○	Parallel port uses Standard protocol.
●	Parallel port uses Fastbytes protocol.

Parallel mode 2

Parallel mode 2 controls whether or not the parallel port data is sampled on the leading or trailing edge of strobe. The default is to sample on the leading edge of strobe, however, some IBM clone personal computers assumes that a printer will sample on the trailing edge.

Perform the following steps to change the parallel mode 2 setting:

1. Enter the configuration mode. See **“Configuration mode” on page 3-14** for more information.
2. Perform a double button press six times. This moves to the parallel mode 2 item on the configuration menu. The parallel mode 2 (Data) light is blinking.
3. The current parallel mode 2 setting is indicated by the off/on/auto (Press Button) light. When the light is off, the parallel mode 2 is set to sample on trailing edge. When the light is on, the parallel mode 2 is set to sample on leading edge. Perform a brief button press to select the parallel mode 2 setting.
4. Perform a long button press. All lights blink once, indicating the setting is saved.
5. Exit the configuration mode by turning the printer power off.

Off/on/auto	Setting value
○	Parallel mode 2 is set to off.
●	Parallel mode 2 is set to on.

Parallel strobe

This setting lets the user adjust the factory setting for the amount of time strobe is sampled to determine that valid data is available on the parallel port. Each increment of the strobe adjust value means the strobe is sampled 50ns longer.

Perform the following steps to change the parallel strobe adjust:

1. Enter the configuration mode. See **“Configuration mode” on page 3-14** for more information.
2. Perform a double button press seven times. This moves to the parallel strobe item on the configuration menu. The parallel strobe (Load Paper) light is blinking.
3. The current parallel strobe setting is indicated by the off/on/auto (Press Button) light. When the light is off, the parallel strobe is set to normal. When the light is on, the parallel strobe is set to +1. When the light is blinking, the parallel strobe is set to +2. Perform a brief button press to select the parallel strobe setting.
4. Perform a long button press. All lights blink once, indicating the setting is saved.
5. Exit the configuration mode by turning the printer power off.

Off/on/auto	Setting value
○	Parallel strobe adjust is set to normal.
●	Parallel strobe adjust is set to +1.
*	Parallel strobe adjust is set to +2.

Data streams

Data stream specifications

Data streams	E320	E322	E322n
PostScript Level 2 emulation	MAC compatibility	Standard	Standard
PPDS	Not available	Standard	Standard

To access the PPDS data stream, the PPDS setting must be set to active. When PPDS is active, the default printer language is changed to PPDS and the default PCL and PostScript SmartSwitch settings are changed to off.

Perform the following steps to change the PPDS setting:

1. Enter the configuration mode. See **“Configuration mode” on page 3-14** for more information.
2. Perform a double button press three times. This moves to the PPDS item on the configuration menu. The PPDS (Paper Jam) light comes on solid.
3. The current PPDS setting is indicated by the off/on/auto (Press Button) light. When the light is off, the PPDS is set to inactive. When the light is on, the PPDS is set to active. Perform a brief button press to select the PPDS setting.
4. Perform a long button press. All lights blink once, indicating the setting is saved.
5. Exit the configuration mode by turning the printer power off.

PPDS active/inactive

If PPDS is active, the following user default printer settings are changed:

- PCL and PostScript SmartSwitch settings for each port are turned off.
- Printer language is changed to PPDS emulation.

If PPDS is inactive, the following user default printer settings are changed:

- PCL and PostScript SmartSwitch settings for each port are turned on.
- Printer language is changed to PCL 5 emulation.

Note: PPDS can be activated using the PJJ LPPDS command.

Off/on/auto	Setting value
○	PPDS is inactive.
●	PPDS is active.

Carriage return line feed/line feed carriage return (CRLF/LFCR)

This function controls whether or not the printer automatically performs a carriage return after a line feed control command and whether or not the printer automatically performs a line feed after a carriage return control command.

Perform the following steps to change the CRLF/LFCR setting:

1. Enter the configuration mode. See **“Configuration mode” on page 3-14** for more information.
2. Perform a double button press four times. This moves to the CRLF/LFCR item on the configuration menu. The CRLF/LFCR (Error) light comes on solid.
3. The current CRLF/LFCR setting is indicated by the off/on/auto (Press Button) light.
 - When the light is off, auto CR after LF is off and auto LF after CR is off.
 - When the light is on, auto CR after LF is on and auto LF after CR is off.
 - When the light is blinking, auto CR after LF is off and auto LF after CR is on.
4. Perform a brief button press to select the CRLF/LFCR setting.
5. Perform a long button press. All lights blink once, indicating the setting is saved.
6. Exit the configuration mode by turning the printer power off.

Auto CRLF/LFCR

Off/on/auto	Setting value
○	Auto CR after LF = off and Auto LF after CR = off.
●	Auto CR after LF is on and Auto LF after CR is off.
*	Auto CR after LF is off and Auto LF after CR is on.

Note: Auto CR after LF = on and auto LF after CR = on can only be set through PjL. The printer's configuration mode only allows the user to set one or the other to on, or both to off. If configuration mode is entered and both settings are set to on, the initial value displayed shows both values off.

USB port

This menu item lets the user enable or disable the USB port. If the port is not being used, disabling it frees allocated memory to be used to process print jobs.

Perform the following steps to change the USB port setting:

1. Enter the configuration mode. See “**Configuration mode**” on **page 3-14** for more information.
2. Perform a double button press eight times. This moves to the USB port item on the configuration menu. The USB port (Paper Jam) light is blinking.
3. The current USB port setting is indicated by the off/on/auto (Press Button) light. When the light is off, the USB port is disabled. When the light is blinking, the USB port is enabled. Perform a brief button press to select a different USB port setting.
4. Perform a long button press. All lights blink once, indicating the setting is saved.
5. Exit the configuration mode by turning the printer power off.

Off/on/auto	Setting value
○	USB port is disabled. The printer doesn't receive data from the USB port.
●	USB port is enabled with a fixed buffer size. The buffer size is set from a utility such as MarkVision. Note: This light state is only displayed if the current value for the USB port enabled setting is a fixed value. The user can't set the value by pressing the button to cycle from the off value to the on value, that is, the button press cycles from off to auto.
*	USB port is enabled with an automatic buffer size. The printer determines the buffer size based on available memory and other printer settings.

USB NPA mode

USB NPA mode allows for two way communication between the host computer and the printer.

Perform the following steps to change the USB NPA setting:

1. Enter the configuration mode. See **“Configuration mode” on page 3-14** for more information.
2. Perform a double button press nine times. This moves to the USB NPA mode item on the configuration menu. The USB NPA (Error) light is blinking.
3. The current USB NPA setting is indicated by the off/on/auto (Press Button) light.
 - When the light is off, the USB port does not search for NPA data within the received data.
 - When the light is blinking, the USB port searches for optional NPA data within the received data.
 - When the light is on solid, the USB port requires that data sent to the printer be in NPA format.
4. Perform a brief button press to select a different USB NPA setting.
5. Perform a long button press. All lights blink once, indicating the setting is saved.
6. Exit the configuration mode by turning the printer power off.

Off/on/auto	Setting value
○	USB port does not search for NPA data within the received data.
●	USB port requires that data sent to the printer be in NPA format.
*	USB port searches for optional NPA data within the received data.

Interface cables

The printer requires a properly grounded and shielded parallel interface cable. The following cables are supported.

Part number	Port	Cable description
1329605	Standard parallel	Lexmark 3 meter (10 ft.) IEEE 1284 compliant A connector (host) to B connector (printer) cable.
1427498	Standard parallel	Lexmark 6 meter (20 ft.) IEEE 1284 compliant A connector (host) to B connector (printer) cable.

3. Diagnostic aids

Diagnostic aids (E220/E321/E323)

Operator panel

Menu definition

The operator panel settings and operations are divided into two menu groups.

Configuration menu group	<p>The configuration menu group contains a set of menus, settings, and operations which are infrequently required by a user. Generally, the options made available in this menu group are used to configure a printer for operation.</p> <p>Access to the configuration menu group is gained by way of a POR key sequence. See “Using the special function menu (E220/E321/E323)” on page 2-106 for more information.</p>
Diagnostic menu group	<p>The diagnostic menu group contains the settings and operations used while manufacturing and servicing the printer. See “Using the special function menu (E220/E321/E323)” on page 2-106 for more information.</p>

The top four lights are on (home state) when the printer is in either configuration or diagnostic mode. The only items that can be changed have one or both Error and Continue lights on.

- Press and release **Cancel** to advance through the menus.
- Press and release **Continue** to advance through the values for a menu item until the desired value is indicated.
- Press and hold **Continue** until all lights cycle to save the value for a menu item.
- Press and hold **Cancel** until all lights cycle to go to the home state.

Configuration menu group or diagnostic menu group

Correct entry of either mode is indicated with the four top lights on. Press and hold **Continue** (about 4 seconds) for the printer to produce a page similar to the ones on **page 3-38** and **page 3-39**, depending on which mode is entered.

Note: For information on how to enter the configuration or diagnostic modes, see **“Using the special function menu (E220/E321/E323)” on page 2-106.**

Moving around the menu

“Printer settings configuration” on page 3-38 and **“Printer diagnostics” on page 3-39**, are similar to the instructions printed by following step 4 on **page 2-106**. These menu items are designated by the non-indented items listed along the left edge of the page. (Bottom as printed from printer.) These items are also unshaded.

- Press and release **Cancel** to move sequentially from one menu item to another.
- Press and hold **Cancel** to jump to home state (top four lights on).
- Press and release **Continue** to move through the menu settings (indicated by Error and Press Continue lights).

This action rotates only through the possible settings of the selected menu item.

Changing settings or printing graphical aids

Select the desired item by pressing and releasing **Cancel**. If the item has settings, press and release **Continue** to select the desired setting.

- Press and hold **Continue** to:
 - Activate printing.
Three pages are in the print quality pages. Instructions for either the configuration or diagnostics mode occupy one page. Continuous (Cont Prt ...) printing can be halted by pressing **Cancel**.
 - Reset defaults.
After resetting factory defaults, the operator panel returns to the configuration menu home state (four top lights on). Settings are retained in NVRAM (as well as ROM).
 - Record selected settings.
After setting new values, the operator panel returns to home state. Settings are retained in NVRAM.

Exceptions are Hex Trace and demo mode activate:

- Select Hex Trace On or demo mode activate
The printer automatically POR's and returns with Ready/Data flashing slowly. Files sent to the printer are printed in Hex Trace.
- Press and hold **Cancel** to leave Hex Trace.
The printer returns to ready state (Ready/Data light on).
- Select demo mode activate
The Ready/Data light comes on solid and the Press Continue light flashes. A demo page prints each time **Continue** is pressed.

After returning to demo mode deactivate, the printer returns to Ready/Data automatically after a few seconds.

Note: After using Hex Trace, return to the printer configuration group by powering the printer off and on. See **“Configuration menu group or diagnostic menu group” on page 3-36** for more information. The printer cannot be returned to the menu home state using the operator panel.

Printer settings configuration

Printer Settings Configuration

This page explains how to access the printer menus and change values. Menus are represented by Ready/Data, Toner Low, Load/Remove Paper, and Paper Jam light sequences. Menu items and their values are indicated by Error and Press Continue light sequences.

Use the illustration to help you find the menu and value you want to change. The Error and Press Continue lights show the current value of the menu item.

- 1 Press and release Cancel to advance through the menus and menu items to the one you need.
 - 2 Press and release Continue to advance to the value you need.
 - 3 Press and hold Continue until all of the lights cycle to perform the function or to save the value.
 - 4 To return to the Home menu, press and hold cancel until all of the lights cycle.
 - 5 Turn the printer off to exit the menus.
- Menus, menu items, and values

	Ready/Data	Toner Low	Load/Remove Paper	Paper Jam	Error	Press Continue
Print Configuration Mode Instructions	●	○	○	○	○	○
Reset Factory Defaults	○	○	○	○	○	○
Hex Trace = Off	○	○	○	○	○	○
Off	○	○	○	○	○	○
On	○	○	○	○	○	○
Print Quality Test Pages	○	○	○	○	○	○
PPDS Emulation = Deactivate	○	○	○	○	○	○
Deactivate	○	○	○	○	○	○
Activate	○	○	○	○	○	○
Demo Mode = Deactivate	○	○	○	○	○	○
Deactivate	○	○	○	○	○	○
Activate	○	○	○	○	○	○
Auto CR after LF = Off	○	○	○	○	○	○
Off	○	○	○	○	○	○
On	○	○	○	○	○	○
Auto LF after CR = Off	○	○	○	○	○	○
Off	○	○	○	○	○	○
On	○	○	○	○	○	○
NPA Mode = Auto	○	○	○	○	○	○
On	○	○	○	○	○	○
Off	○	○	○	○	○	○
Auto	○	○	○	○	○	○
MAC Binary PS = Auto	○	○	○	○	○	○
On	○	○	○	○	○	○
Off	○	○	○	○	○	○
Auto	○	○	○	○	○	○
NPA Mode = Auto	○	○	○	○	○	○
On	○	○	○	○	○	○
Off	○	○	○	○	○	○
Auto	○	○	○	○	○	○
MAC Binary PS = Auto	○	○	○	○	○	○
On	○	○	○	○	○	○
Off	○	○	○	○	○	○
Auto	○	○	○	○	○	○
Set Card Speed = Auto	○	○	○	○	○	○
Auto	○	○	○	○	○	○
10 Mbps, Half Duplex	○	○	○	○	○	○
10 Mbps, Full Duplex	○	○	○	○	○	○
100 Mbps, Half Duplex	○	○	○	○	○	○
100 Mbps, Full Duplex	○	○	○	○	○	○

●	Light On
○	Light Off
*	Light Blinking
Value	Value

Printer diagnostics

Printer Diagnostics

This page explains how to access the printer menus and change values. Menus are represented by Ready/Data, Toner Low, Load/Remove Paper, and Paper Jam light sequences. Menu items and their values are indicated by Error and Press Continue light sequences.

Use the illustration to help you find the menu and value you want to change. The Error and Press Continue lights show the current value of the menu item.

- 1 Press and release Continue to advance through the menus and menu items to the one you need.
 - 2 Press and release Continue to advance through the menus and menu items to the one you need.
 - 3 Press and hold Continue until all of the lights cycle to perform the function or to save the value.
 - 4 To return to the Home menu, press and hold Cancel until all of the lights cycle.
 - 5 Turn the printer off to exit the menus.
- Menus, menu items, and values

	Development	Parallel	Network
Ready/Data	●	○	○
Toner Low	○	○	○
Load Paper	○	○	○
Paper Jam	○	○	○
Error	●	○	○
Press Continue	○	○	○
Print Diag Inst	○	○	○
Edge to Edge = Off	○	○	○
Off	○	○	○
On	○	○	○
Prt Quality Pgs	○	○	○
Cont Prt Simplex Tray 1	○	○	○
Cont Prt Simplex Tray 2	○	○	○
Print History	○	○	○
Defaults = U.S.	○	○	○
U.S.	○	○	○
Non-U.S.	○	○	○
Configuration ID = 000101	○	○	○
000101	○	○	○
000189	○	○	○
Par S Strobe Adj = 0	○	○	○
-1	○	○	○
0	○	○	○
1	○	○	○
2	○	○	○
3	○	○	○
History	○	○	○
Mark History = Do Not Mark	○	○	○
Mark	○	○	○
Do Not Mark	○	○	○
History Mode = Modified	○	○	○
Modified	○	○	○
Every Time	○	○	○
Dump NVRAM	○	○	○
Reinit NVRAM	○	○	○
Optra Forms Mode = Off	○	○	○
On	○	○	○
Off	○	○	○
Meditech Mode = No	○	○	○
Yes	○	○	○
No	○	○	○

- Light On
- Light Off
- * Light Blinking
- Value

Printer diagnostics mode

The printer diagnostics mode is for service use only. Its manipulation is the same as the configuration mode. The following functions can be performed in the diagnostics mode. See “**Configuration menu group or diagnostic menu group**” on page 3-36 for more information.

1. Print diagnostic instructions and menu settings by pressing and holding **Continue** until the lights cycle.

We recommend this sheet be run and checked anytime diagnostics mode is entered. It provides instructions in the manipulation of the menu.

2. Set edge-to-edge printing on/off.
 - Off is the default and normal setting which allows the printer graphics and printing engine to set the margins accordingly.
 - When edge-to-edge is set on, the printer graphic and printing engine shift all four margins to the physical edges of the paper.
3. Print the print quality pages.
 - These are the same pages that are run in the configuration mode.

Note: The toner cartridge lockout function is disabled in this mode.

 - In the configuration mode, the lockout function is enabled which means the pages cannot be printed unless the toner cartridge has a machine class ID that matches the machine class ID held in NVRAM on the operator panel card.
4. Print simplex from Tray 1, or Tray 2 (if installed). This sheet runs continuously until **Cancel** is pressed. It can be used for skew or printhead adjustments.
5. ‘Defaults=’ allows the printer to be set for U.S. or non-U.S. after the controller card has been replaced.
6. Configuration ID allows the printer to have the ID set to match the label after the controller card has been replaced.

7. Par S strobe adjustment for the parallel port can be set to four additional settings in addition to the default setting. Pull-up resistors are only enabled indicating parallel mode 1 is not supported. (Parallel mode 2 is supported and can be turned off or on in the configuration mode.) Adjustments may have to be made if an unusually long parallel cable is being used.
8. Network settings for mark history, history mode, Optra Forms™ mode, and meditech mode can be set.
 - A service error history report (network) can be printed.
 - Dump NVRAM prints a hex dump of the NVRAM partition and the re-init NVRAM resets the network NVRAM to the factory defaults.

Note: When a controller card is changed in a network printer, print the menu and network sheets. (After POR, press **Continue**.) If the “Printer Type” under “Integrated Network Option Settings” does not match the “Name” under “Appletalk”, go into the printer diagnostics mode and reinitialize NVRAM (“Reinit NVRAM”). Verify that the names match after reprinting the network sheet.

4. Repair information

Warning: Read the following before handling electronic parts.

Handling electrostatic discharge (ESD)-sensitive parts

Many electronic products use parts that are known to be sensitive to electrostatic discharge (ESD). To prevent damage to ESD-sensitive parts, follow the instructions below in addition to all the usual precautions, such as turning off power before removing logic boards:

- Keep the ESD-sensitive part in its original shipping container (a special “ESD bag”) until you are ready to install the part into the printer.
- Make the least-possible movements with your body to prevent an increase of static electricity from clothing fibers, carpets, and furniture.
- Put the ESD wrist strap on your wrist. Connect the wrist band to the system ground point. This discharges any static electricity in your body to the printer.
- Hold the ESD-sensitive part by its edge connector shroud (cover); *do not* touch its pins. If you are removing a pluggable module, use the correct tool.
- *Do not* place the ESD-sensitive part on the printer cover or on a metal table; if you need to put down the ESD-sensitive part for any reason, first put it into its special bag.
- Machine covers and metal tables are electrical grounds. They increase the risk of damage because they make a discharge path from your body through the ESD-sensitive part. (Large metal objects can be discharge paths without being grounded.)
- Prevent ESD-sensitive parts from being accidentally touched by other personnel. Install machine covers when you are not working on the machine, and *do not* put unprotected ESD-sensitive parts on a table.
- If possible, keep all ESD-sensitive parts in a grounded metal cabinet (case).
- Be extra careful in working with ESD-sensitive parts when cold-weather heating is used because low humidity increases static electricity.

Adjustment

Printhead assembly

The printhead may need to be adjusted after it has been reinstalled. Tighten the four screws just enough to still move the printhead frame.

Note: Always check the printhead alignment after replacing the operator panel assembly. Settings on the original card may not be the same as on the new operator panel card. Only a skew adjustment can be made; margins cannot be adjusted. Contact the next level of support or call Lexmark (800) 539-6275 for assistance with margins.

To perform the registration check and adjustment:

1. Open the front door.
2. Press and hold **Cancel** while turning the printer on.
3. Hold **Cancel** until the lights have cycled on and off.
4. Close the door when the Error light comes on. Wait for the four top lights to stay on.
5. Press and release **Cancel** once and wait for Ready/Data to come on.
6. Press and release **Cancel** again and wait for Toner Low light.
7. Press and release **Cancel** again and wait for both Ready/Data and Toner Low lights.
8. Press and hold **Continue** until lights cycle.
9. Once the printer starts to print, press **Cancel** or the same sheet prints continuously.
Check margins and skew (top or bottom lines relative to edge of paper). See **Note** above.
10. Adjust the printhead as necessary.
This adjustment can only correct for skew. Adjust the left side of the printhead until the top (or bottom) line is parallel to the paper edge.
11. After obtaining a proper adjustment, tighten all four screws.

Lubrication

The gears in the main drive assembly (PN 12G4500 and PN 56P2441) need to be lubricated when a new assembly is installed. Place a drop size or less of lubricant on each gear as shown below and rotate the gears to evenly distribute the lubricant. Use Nyogel 744 (PN 99A0394) or IBM 23 (PN 99A0462).

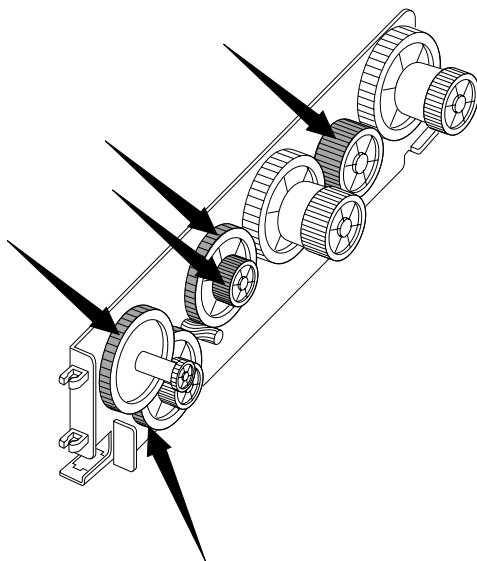

Removal procedures



Be sure to unplug the power cord whenever you are working on the printer with one of the covers removed. Be sure to remove the print cartridge before you perform removal procedures.

Cover removals

Access cover

1. Open the front access cover.
2. Press the center of the access cover down to release the side pivot points.
3. Remove the access cover.

Front cover

1. Open the front cover.
2. Remove the two plastic clips from the front cover support arm hinges.
Note: Support and ease the charge roll assembly into a resting position when disengaging the front cover support arm hinges.
3. Disengage the front cover support arm hinges from the charge roll assembly.
4. Release the front cover from its pivot points.

Note: Lay the front cover to one side as the operator panel cable is attached to the controller card. See **“Right side cover” on page 4-5** and **“Controller card cage removal” on page 4-7** for more information.

Top cover

1. Open the front cover.
2. Remove the two top cover screws.
3. Remove the top cover.

Right side cover

1. Open the front cover. See **“Front cover” on page 4-4** for more information.
2. Press the two right side cover finger tabs while releasing the center tab.
3. Remove the right side cover.

Left side cover

1. Open the front cover. See **“Front cover” on page 4-4** for more information.
2. Remove the top cover. See **“Top cover” on page 4-4** for more information.
3. Remove the left side cover screw.
4. Release the left side cover tabs (2).
5. Remove the left side cover.

Auto sheet feed (ASF) assembly removal

1. Open the front cover. See **“Front cover” on page 4-4** for more information.
2. Remove the top cover. See **“Top cover” on page 4-4** for more information.
3. Remove the left side cover. See **“Left side cover” on page 4-5** for more information.
4. Remove the right side cover. See **“Right side cover” on page 4-5** for more information.
5. Remove the two lower ASF screws.
6. Tilt or swing the lower rear auto sheet feed cover away from the printer and remove.
7. Remove the two upper ASF screws.
8. Remove the ground strap screw attached at the gear drive.
9. Tilt or swing the top of the ASF away from the printer to disengage the elongated hinge pivots.
10. Remove the auto sheet feed.

Charge roll assembly removal

Note: To replace a charge roll without removing the assembly, remove the screw on the left side of the charge roll. Carefully separate the charge roll from the left hinge and extract the roll without displacing the shutter.

1. Remove the front cover. See **“Front cover” on page 4-4** for more information.
2. Remove the top cover. See **“Top cover” on page 4-4** for more information.
3. Remove the left side cover. See **“Left side cover” on page 4-5** for more information.
4. Remove two cooling fan screws.
5. Remove the toner cartridge.
6. Remove controller card cage. See **“Controller card cage removal” on page 4-7** for more information.
7. Remove the two fuser top cover screws.
8. Remove fuser top cover.
9. Remove left and right charge roll assembly brackets.

Note: When reinstalling charge roll assembly brackets, ensure brass spring is on the left and silver spring is on the right.
10. Remove charge roll assembly.

Controller card cage removal

1. Open the front cover. See **“Front cover” on page 4-4** for more information.
2. Remove the right side cover. See **“Right side cover” on page 4-5** for more information.
3. Remove the controller card. See **“Controller card removal” on page 4-7** for more information.
4. Loosen the three screws along the bottom edge, remove the fourth screw at the rear and remove the cage.

Controller card removal

Warning: For E220/E321/E323, *do not* replace the operator panel and controller card at the same time. Each card contains the printer settings. When either of these cards is new, it obtains the settings from the other card. Settings are lost when both are new at the same time.

1. Open the front cover. See **“Front cover” on page 4-4** for more information.
2. Remove the right side cover. See **“Right side cover” on page 4-5** for more information.
3. Remove the controller card cover screw.
4. Disconnect cables from the controller card.
5. Remove the two parallel cable screws.
6. Remove the four controller card screws.
7. Remove the controller card.

Cooling fan removal

1. Open the front cover. See **“Front cover” on page 4-4** for more information.
2. Remove the top cover. See **“Top cover” on page 4-4** for more information.
3. Remove the left side cover. See **“Left side cover” on page 4-5** for more information.
4. Remove two cooling fan screws.
5. Remove the toner cartridge.
6. For the E220/E321/E323, remove the right side cover and the controller board cover.
7. Tilt the printer carefully to the rear so it is resting on the ASF.
8. Remove the four bottom cover screws.
9. Disconnect the cooling fan cable from the engine card (E320/E322) or controller board (E220/E321/E323).
10. Remove the cooling fan.

D-roll removal

1. Remove the front cover. See **“Front cover” on page 4-4** for more information.
2. Remove top cover. See **“Top cover” on page 4-4** for more information.
3. Remove rear auto sheet feed cover. See **“Auto sheet feed (ASF) assembly removal” on page 4-5** for more information.
4. Remove right side cover. See **“Right side cover” on page 4-5** for more information.
5. Remove controller card cage. See **“Controller card cage removal” on page 4-7** for more information.
6. Disconnect the printer motor cable.
7. Remove optional Tray 2 connector from bracket.
8. Remove the four main drive gear assembly screws.
9. Remove the main drive gear assembly with drive motor from printer.
10. Depress paper feed solenoid locking tab and slide paper feed solenoid off D-roll assembly shaft.
11. Remove the HVPS board. See **“High voltage power supply (HVPS) removal” on page 4-10** for more information.
12. Rotate the D-roll shaft retaining clips to loosen.
13. Remove the D-roll assembly.

Engine board removal (E320/E322 only)



1. Unplug the printer.
2. Remove the toner cartridge.
3. Tilt the printer carefully to the rear so it is resting on the ASF.
4. Remove the four bottom cover screws.
5. Disconnect the cables.
6. Remove the four engine board screws.
7. Remove the engine board.

Fuser assembly removal



1. Unplug the printer.
2. Tilt the printer carefully to the rear so it is resting on the ASF.
3. Remove the four bottom cover screws.
4. Disconnect J7 (thermistor (THM)) from engine card (E320/E322) or J14 and J22 on the controller card (E220/E321/E323). Extract cables.
5. Reattach bottom cover and set printer upright.
6. Remove charge roll assembly. See **“Charge roll assembly removal” on page 4-6** for more information.
7. Remove the two fuser mounting screws.
8. Disconnect the fuser wires.
9. Release the tabs on each end of fuser assembly and lift out.

High voltage power supply (HVPS) removal



1. Unplug the printer.
2. Open the front cover. See **“Front cover” on page 4-4** for more information.
3. Remove the top cover. See **“Top cover” on page 4-4** for more information.
4. Remove the left side cover. See **“Left side cover” on page 4-5** for more information.
5. Remove the four HVPS board screws.
6. Disconnect connector from the HVPS board.
7. Remove the HVPS board.

Note: Use care with compression springs as they can fall out.

Low voltage power supply (LVPS) removal



1. Unplug the printer.
2. Remove the toner cartridge.
3. Tilt the printer carefully to the rear so it is resting on the ASF.
4. Remove the four bottom cover screws.
5. Disconnect the cables.
6. Remove four LVPS board screws.
7. Remove the LVPS board.

Operator panel removal

Warning: For E220/E321/E323, *do not* replace the operator panel and controller card at the same time. Each card contains the printer settings. When either of these cards is new, it obtains the settings from the other card. Settings are lost when both are new at the same time.

1. Open front cover. See **“Top cover” on page 4-4** for more information.
2. Remove right side cover. See **“Right side cover” on page 4-5** for more information.
3. Remove controller cage cover. **“Controller card cage removal” on page 4-7** for more information.
4. Unplug operator panel at J18 on the controller card.
5. Remove operator panel.

Paper feed clutch solenoid removal

1. Remove the front cover. See **“Front cover” on page 4-4** for more information.
2. Remove top cover. See **“Top cover” on page 4-4** for more information.
3. Remove rear auto sheet feed cover. See **“Auto sheet feed (ASF) assembly removal” on page 4-5** for more information.
4. Remove right side cover. See **“Right side cover” on page 4-5** for more information.
5. Remove controller card cage. See **“Controller card cage removal” on page 4-7** for more information.
6. Disconnect the drive motor cable.
7. Remove optional Tray 2 connector from bracket.
8. Remove the four main drive gear assembly screws.
9. Remove the main drive gear assembly with drive motor from printer.
10. Depress paper feed solenoid locking tab and slide paper feed solenoid off D-roll assembly shaft.
11. Remove the toner cartridge.
12. Tilt the printer carefully to the rear so it is resting on the ASF.
13. Remove the four bottom cover screws.
14. Disconnect paper feed clutch solenoid cable from engine card (E320/E322 only). Extract the cable for all models.
15. Remove the paper feed clutch solenoid.

Printhead assembly removal

1. Open the front cover. See **“Front cover” on page 4-4** for more information.
2. Remove the top cover. See **“Top cover” on page 4-4** for more information.
3. Remove the four top screws from the printhead mounting plate.
4. Remove the printhead plate ground strap screw above the HVPS.
5. Remove the controller cage screw from the printhead mounting plate.
6. Disconnect the printhead cables (first at the controller card for E220/E321/E323 only).
7. Remove the three printhead screws (E320/E322 only).
8. Remove the printhead.

Transfer roll removal

1. Open the front cover and remove the toner cartridge. See **“Front cover” on page 4-4** for more information.
2. Release the transfer roll left and right bearing.
3. Remove the transfer roll.

5. Connector locations

LVPS—low voltage power supply board

Connector	Pin no.	Signal
CN1	1	AC H
	2	AC N
CN2	1	Heater on
	2	AC N
CN3	1	Ground
	2	+5 V dc
	3	+5 V dc
	4	Ground
	5	+24 V dc
	6	+24 V dc
	7	Ground
	8	Ground
	9	Heater on
	10	Heater on sub

Note: The LVPS part number for E320/E322 and E220/E321/E323 is different but the input/output values are the same.

HVPS–high voltage power supply board

Connector	Pin no.	Signal
CN1 HVPS	1	Developer PWM
	2	Ground
	3	Charge
	4	+24 V dc
	5	Transfer PWM
	6	Transfer enable
	7	Not used
	8	Transfer servo

Engine board (E320/E322 only)

Connector	Pin no.	Signal
J1 HVPS	1	Developer PWM
	2	Ground
	3	Charge
	4	+24 V dc
	5	Transfer PWM
	6	Transfer enable
	7	Not used
	8	Transfer servo
J2 Input/Exit Sensor	1	Ground
	2	Input sensor
	3	Light drive
	4	Ground
	5	Exit sensor
	6	Light drive

Connector	Pin no.	Signal
J3 Cartridge Chip	1	Cartridge data
	2	Ground
J4 Fan Control	1	+24 V dc
	2	Fan control
J5 Main Motor	1	+24 V dc
	2	Ground
	3	Motor enable
	4	Ground
	5	Motor signal
J6 Toner Sensor	1	Ground
	2	Toner signal
	3	Light drive
J7 Thermistor	1	Thermistor data
	2	Ground
J8 Not used	1	
	2	
J9 Cover Open Switch	1	+24 V dc
	2	Interlock switch
J10 Paper Pick Solenoid	1	+24 V dc
	2	Solenoid control

Connector	Pin no.	Signal
J11 Controller, Printhead, and Mirror Motor	1	Printhead CLK
	2	Controller reset
	3	Ready
	4	Ground
	5	Start
	6	Engine notify
	7	Ground
	8	Controller present
	9	+24 V dc
	10	SCL
	11	Sample and hold
	12	Ground
	13	Printhead enable
	14	SDA
	15	Ground
	16	+5 V dc
	17	LSU power
	18	Ground
	19	Ground
	20	LSYNC
	21	HSYNC
	22	Ground
	23	Not used
	24	Sample and hold

Connector	Pin no.	Signal
J12 PSU	1	+5 V dc
	2	Ground
	3	Interlock switch
	4	Interlock switch
	5	Ground
	6	Ground
	7	Fuser control
	8	Hot roll power
J13 Option Tray	1	Transmit
	2	Receive
	3	Tray detect
	4	+5 V dc
	5	Ground
	6	+24 V dc

RIP controller (E320/E322 only)

Connector	Pin no.	Signal
J2 Light Op Panel	1	Ground
	2	FPIRQ
	3	Light CLK
	4	Light data
	5	+5 V dc
	6	Ground
J3 Video	1	Video
	2	Ground
J7 Controller to Engine	1	Engine POR
	2	Ground
	3	Notify
	4	Controller present
	5	SCL
	6	Ground
	7	DSA
	8	HSYNC
	9	Ground
	10	VSYNC
	11	Ground
	12	Laser on
J8 Power	1	+5 V dc
	2	Ground

Controller (E220/E321/E323 only)

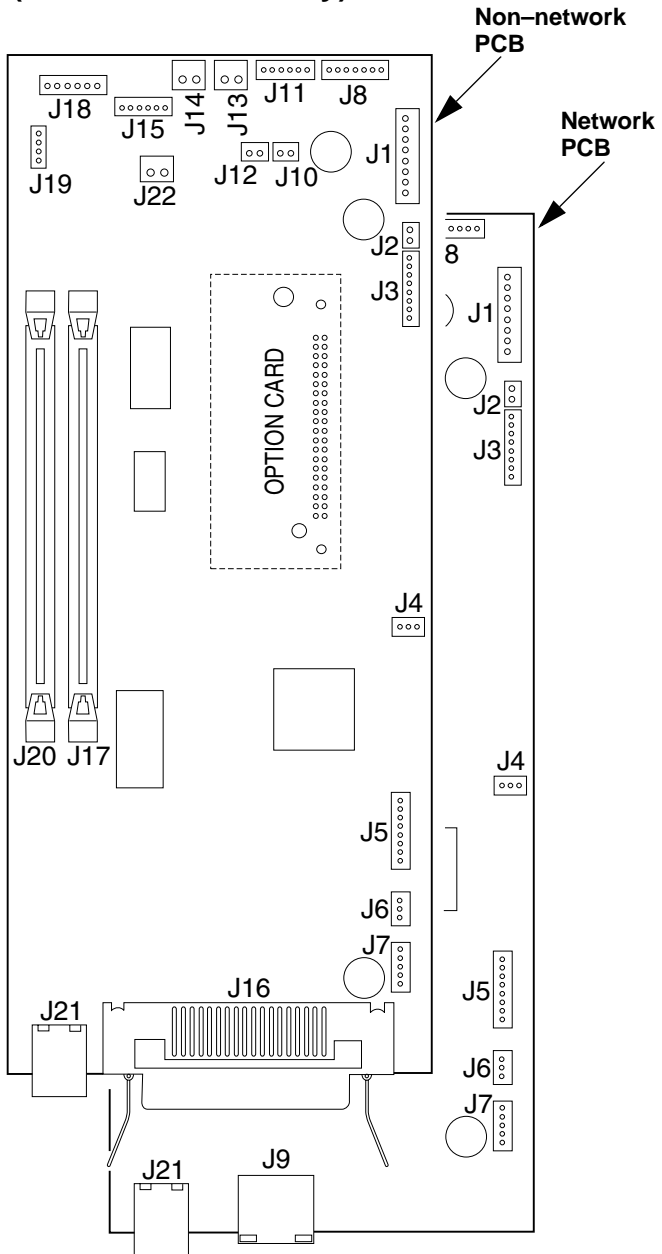

RIP controller (E220/E321/E323 only)

Note: (I) indicates input (check with cable connected).

Connector	Pin no.	Signal
J1 LVPS	1	+5 V dc (I)
	2, 5, 6	Ground (I)
	3, 4	+24 V dc (I)
	7	ZEROX_C
	8	HR_PSU
J2 Fan	1	+24 V dc
	2	Return
J3 HVPS	1	DEV_C
	2	Ground
	3	CHARGE_C
	4	+24 V dc
	5	TX_C
	6	TXENABLE_C
	8	SERVO_OUT_C
J4 Toner	1	Ground
	2	TONER_END
	3	<+5 V dc
J5 LSU	1, 5, 7	Ground
	2	VDO_ADJ_C
	3	VIDEO_C
	4	<LEN_C
	6	+5 V dc (front cover closed)
	8	HSYNC_C

Connector	Pin no.	Signal
J6 Cover open	1	+5 V dc (cover closed) (I)
	1	0 V (cover open) (I)
	2	+5 V dc
	3	Ground
J7 Mirror motor	1	MM_REF_C
	2	MM_LOCK_C
	3	MM_START_C
	4	Ground
	5	+24 V dc
J8 Main motor	1, 6	Ground
	2	XPRT_FB
	3	XPRT_SPEED_R
	4	XPRT_EN_C
	5	XPRT_LOCK_C
	7	+24 V dc
J9 Network (network printer only)		
J10 Erase		
J11 Paper Sensor	1, 4	Ground
	2	PAPER_IN
	3	<+5 V dc
	5	PAPER_OUT
	6	<+5 V dc
J12 Solenoid	1	FDSOL+, +24 V dc pulse
	2	FDSOL -
J13 Smart Chip	1	DC_DATA_C
	2	Ground

4500

Connector	Pin no.	Signal
J14 thermistor 1	1	FUSER_TH_C
	2	Ground
J15 Second Drawer (option)	1	TX
	2	RX
	3	Tray2_C
	4	+5 V dc
	5	Ground
	6	+24 V dc
J16 Parallel Port (non-network printer only)		
J17 DIMM		
J18 LED operator panel	1	Ground
	2	+5 V dc Continue button 1(I)
	2	0 V dc Continue pressed
	3	LED, CLK
	4	LED, DATA
	5	+5 V dc
	6	+5 V dc Cancel button 2 (I)
	6	0 V dc Cancel pressed
	7	SCL
J19 Blank		
J20 DIMM		
J21 USB		
J22 Thermistor 2	1	FUSER_TH2_C
	2	Ground

Option card (replaceable on E320/E322 only)

Connector	Pin no.	Signal
CN4 to Engine Card	1	RX
	2	TX
	3	COM1
	4	+5 V dc
	5	COM1
	6	+24 V dc
CN5 to Motor	1	STP_A
	2	STP_Na
	3	STP_B
	4	STP_nB
CN6 to Solenoid	1	SOI
	2	FB_SOL
CN7 to PIC_JIG (Flash Down Load)	1	PGM_RESET
	2	+5 V dc
	3	COM1
	4	PGM_DATA
	5	PGM_CLK

E220/E321/E323 wiring diagram

Lexmark E220/E321/E323
System Board Wiring Diagram

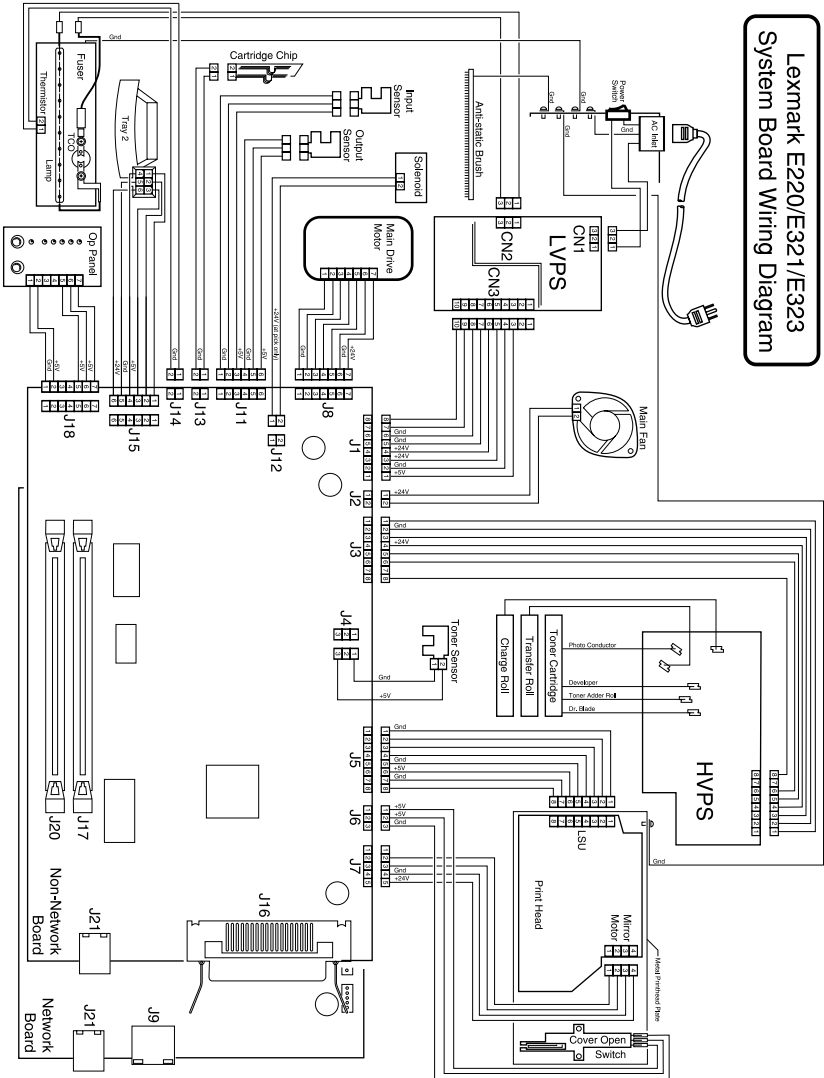

6. Preventive maintenance

The E220/E32x does not require preventive maintenance.

7. Parts catalog

How to use this parts catalog

- **SIMILAR ASSEMBLIES:** If two assemblies contain a majority of identical parts, they are shown on the same list. Common parts are shown by one index number. Parts peculiar to one or the other of the assemblies are listed separately and identified by description.
- **NA** (not available) means not available as a FRU.
- **NS:** (not shown) in the Asm-index column indicates that the part is procurable but is not pictured in the illustration.
- **PP:** (parts packet) in the parts description column indicates the part is contained in a parts packet.

Assembly 1: Covers (E320/E322)

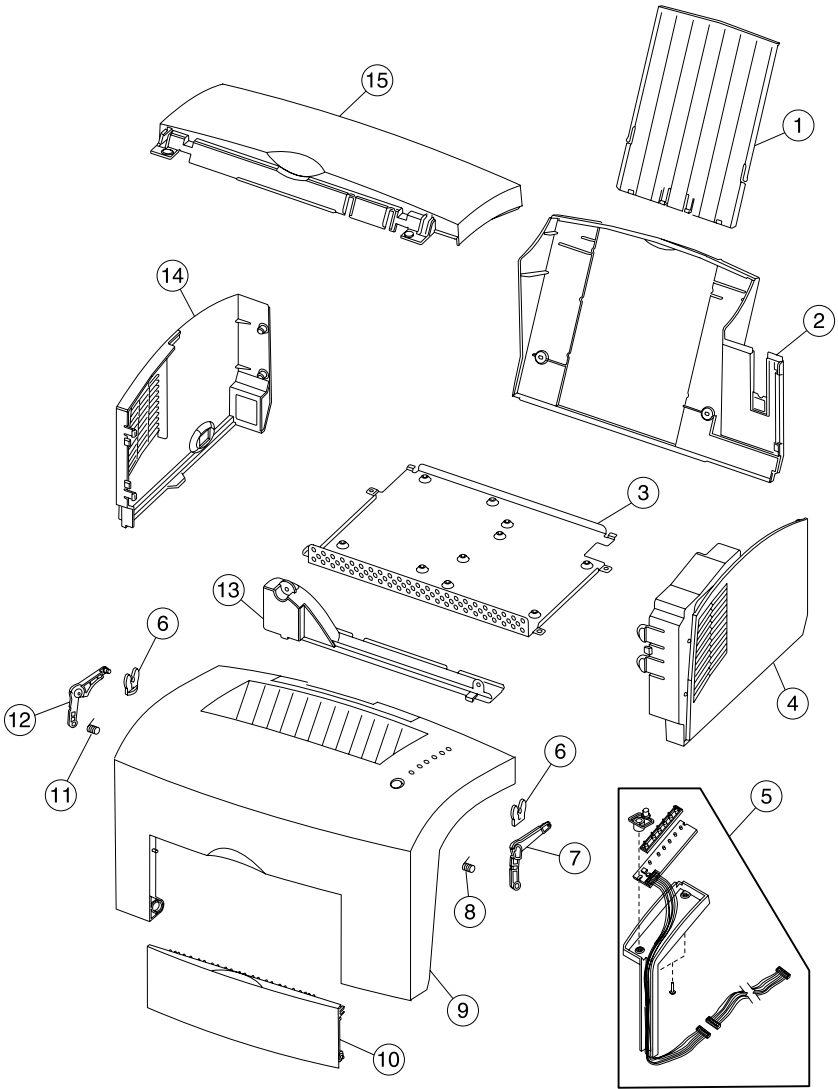

Assembly 1: Covers (E320/E322)

Asm-index	Part number	Units	Description
1-1	12G4456	1	Extension, tray
2	12G4455	1	Cover, rear
3	12G4458	1	Cover, bottom
4	12G4453	1	Cover, right side
5	12G4457	1	Assembly, operator panel
6*	56P1099	1	Parts pack, bushings clip spring
7	56P2373	1	Hinge, right
8	12G4535	1	Spring, front cover right
9	12G4543	1	Cover, front-E320
9	12G4542	1	Cover, front-E322
10	12G4450	1	Cover, access
11	12G4536	1	Spring, front cover left
12	56P2374	1	Hinge, left
13	12G4459	1	Duct, cooling
14	12G4451	1	Cover, left side
15	12G4452	1	Cover, top
NS	12G0176	1	Cover, media

* Contact Lexmark for availability.

Assembly 1 (cont.): Covers (E220/E321/E323)

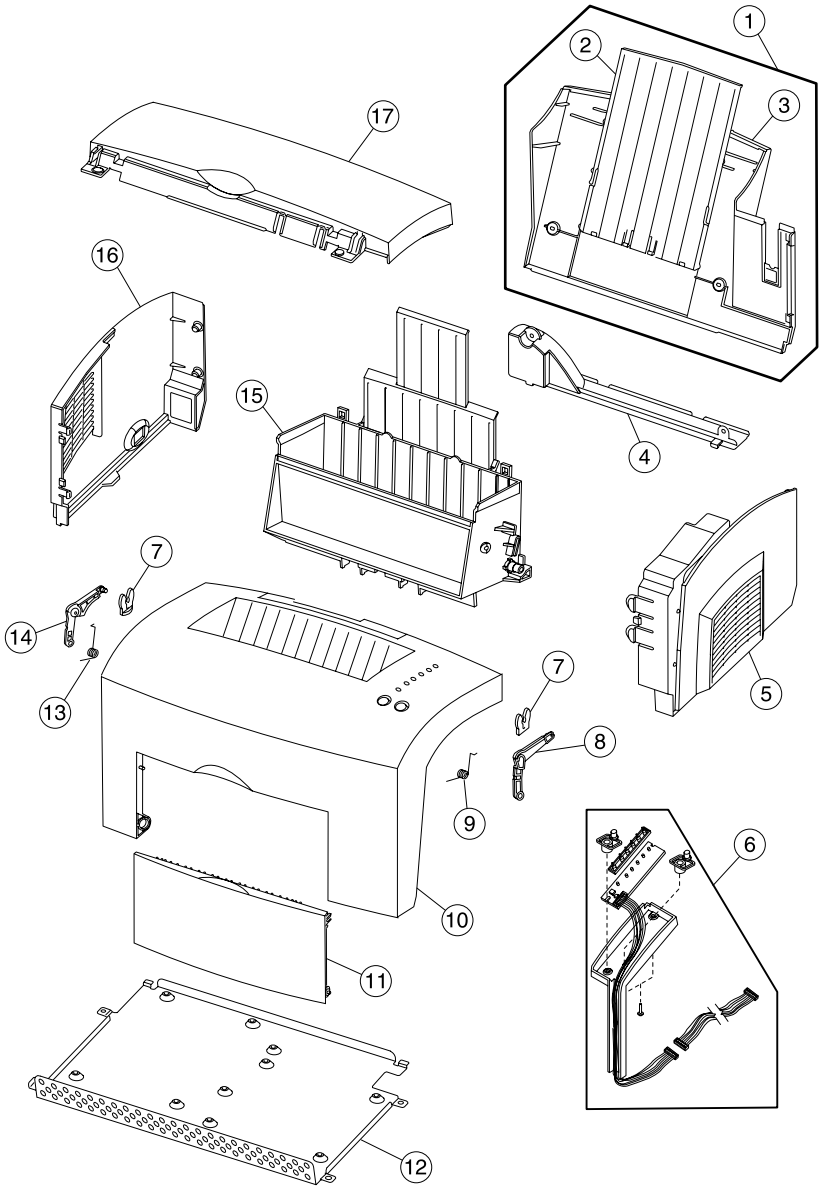

Assembly 1 (cont.): Covers (E220/E321/E323)

Asm-index	Part number	Units	Description
1-1*	56P1078	1	Assembly, cover, rear
2	12G4456	1	Extension, tray (white)
3	12G4455	1	Cover, rear (white)
4*	56P1086	1	Duct, cooling
4	12G4459	1	Duct, cooling (white)
5*	56P1050	1	Cover, right side
5*	56P1084	1	Cover, right side (white)
6	56P1051	1	Assembly, operator panel
6	56P0683	1	Assembly, operator panel (white)
6	56P1839	1	Assembly, operator panel (E220)
6	56P1838	1	Assembly, operator panel (E220) (white)
7*	56P1099	1	Parts pack, bushings clip spring
8	56P2373	1	Hinge, right
9	12G4535	1	Spring, front cover right
10*	56P1837	1	Cover, front – E220
10*	56P1836	1	Cover, front – E220 (white)
10*	56P1064	1	Cover, front – E321
10*	56P1065	1	Cover, front – E323
10*	56P1095	1	Cover, front, E321 (white)
10*	56P1096	1	Cover, front, E323 (white)
11*	56P1075	1	Cover, access
11	12G4450	1	Cover, access (white)
12	12G4458	1	Cover, bottom
13	12G4536	1	Spring, front cover left
14	56P2374	1	Hinge, left

* Contact Lexmark for availability.

Assembly 1 (cont.): Covers (E220/E321/E323)

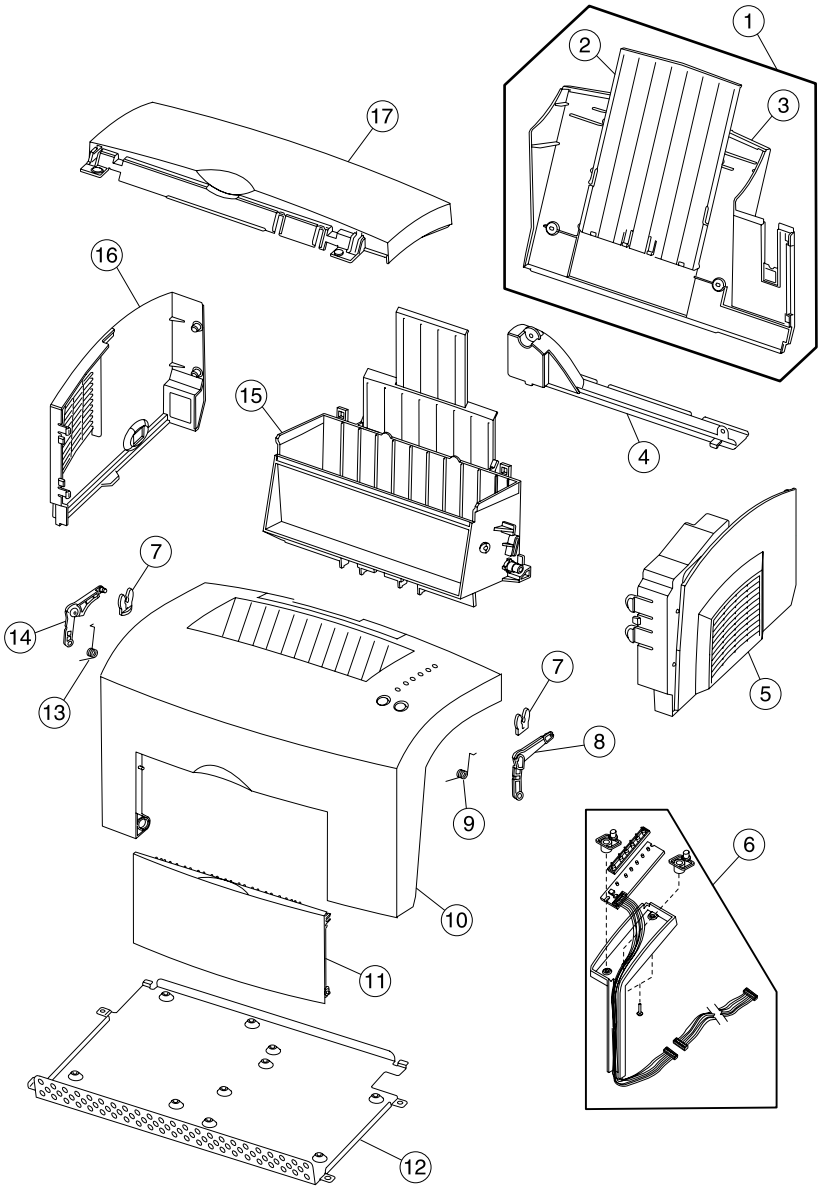

Assembly 1 (cont.): Covers (E220/E321/E323)

Asm-index	Part number	Units	Description
15*	56P1094	1	Assembly, paper guide with exit tray (black)
15*	56P1091	1	Assembly, paper guide with exit tray (white)
16*	56P1076	1	Cover, left side
16	12G4451	1	Cover, left side (white)
17*	56P1077	1	Cover, top
17*	12G4452	1	Cover, top (white)
NS	12G0176	1	Cover, media

* Contact Lexmark for availability.

Assembly 2: Frame

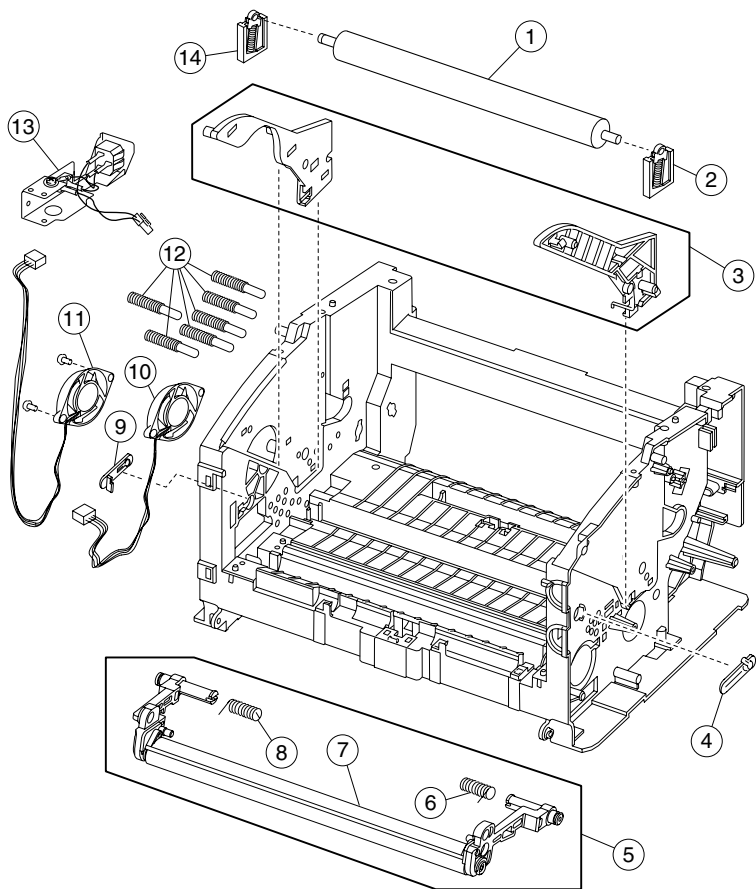

Assembly 2: Frame

Asm-index	Part number	Units	Description
2-1	12G4470	1	Roll, transfer
2	12G4471	1	Bearing, transfer
3	12G4473	1	Bill of material (B/M), rail (E320/E322 only)
3*	56P1085	1	B/M, rail (E220/E321/E323 only)
4	12G4534	1	Bracket, right
5	56P0685	1	Assembly, charge roll
6	12G4464	1	Spring, charge roll right
7	99A1017	1	Roll, charge
8	12G4463	1	Spring, charge roll left
9	12G4533	1	Bracket, left
10	12G4460	1	Fan, cooling (E320/E322 only)
11*	56P1052	1	Fan, cooling (E220/E321/E323)
12	12G4510	6	Spring, HVPS (6/FRU)
13	12G4461	1	Switch asm., power (white-110V)
13*	56P1092	1	Switch asm., power (black-110V))
13*	56P0687	1	Switch asm., power (white-220V)
13*	56P0688	1	Switch asm., power (black-220V)
14	56P0199	1	Bearing, left transfer

* Contact Lexmark for availability.

Assembly 3: Fuser

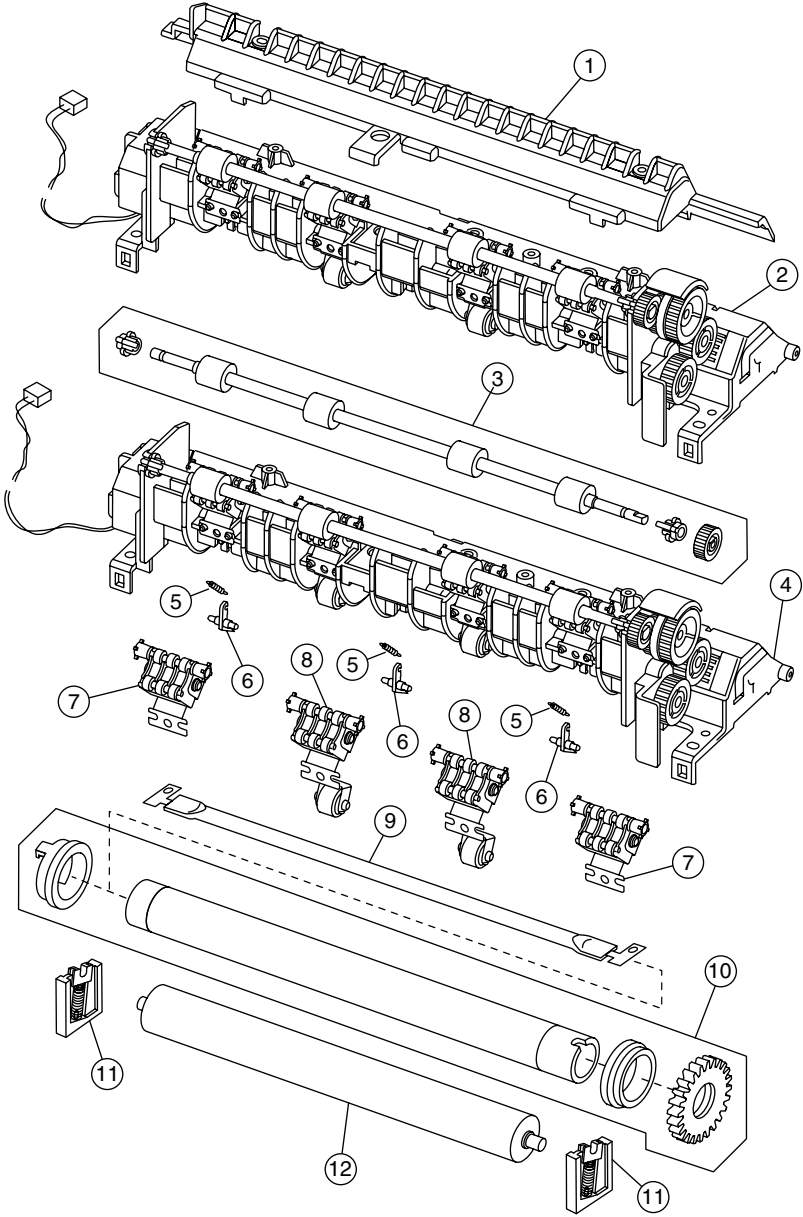

Assembly 3: Fuser

Asm-index	Part number	Units	Description
3-1	12G4488	1	Cover, fuser (E320/E322 only)
1*	56P1082	1	Cover, fuser (E220/E321/E323 only)
2	12G4484	1	Fuser assembly, 110 V (E320/E322 only)
2	12G4486	1	Fuser assembly, 220 V (E320/E322 only)
3	12G4493	1	Roller, exit, redrive
4	56P1053	1	Fuser assembly, 110 V (E220/E321/E323 only)
4	56P1054	1	Fuser assembly, 220 V (E220/E321/E323 only)
5*	56P1099	3	Parts pack, bushings/clip spring
6	12G4495	3	Pawl, detack (1 each)
7	12G4496	4	Roll assembly, idler (1 each)
8	12G4492	2	Roller, exit, idler (1 each)
9	12G4485	1	Lamp, fuser, 110 V
9	12G4487	1	Lamp, fuser, 220 V
10	12G4491	1	Roll, fuser, hot
11	12G4489	2	Bearing, backup roll
12	12G4494	1	Roll, fuser, backup

* Contact Lexmark for availability.

Assembly 4: Main drive

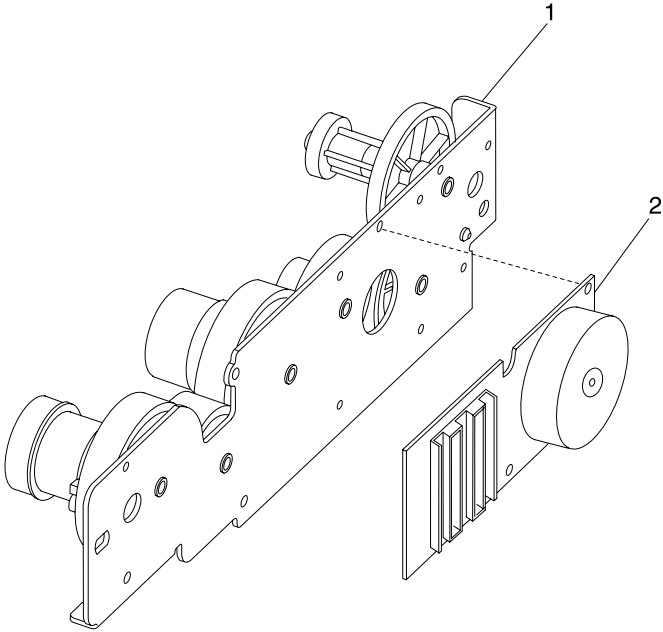

Assembly 4: Main drive

Asm-index	Part number	Units	Description
4-1*	12G4500	1	Gear assembly, drive (E320/E322)
1*	56P2441	1	Gear assembly, drive (E220/E321/E323)
2	12G4499	1	Motor, drive (E320/E322 only)
2	56P1083	1	Motor, drive (E220/E321/E323)

* Order PN 99A0394 (Nyogel 744 lubricant) to be applied to gear assembly. See [page 4-3](#) for more information.

Note: PNs 12G4500 and 56P0684 differ only in the cable clamps. The cable clamps can be removed and interchanged as needed.

Assembly 5: Paper feed

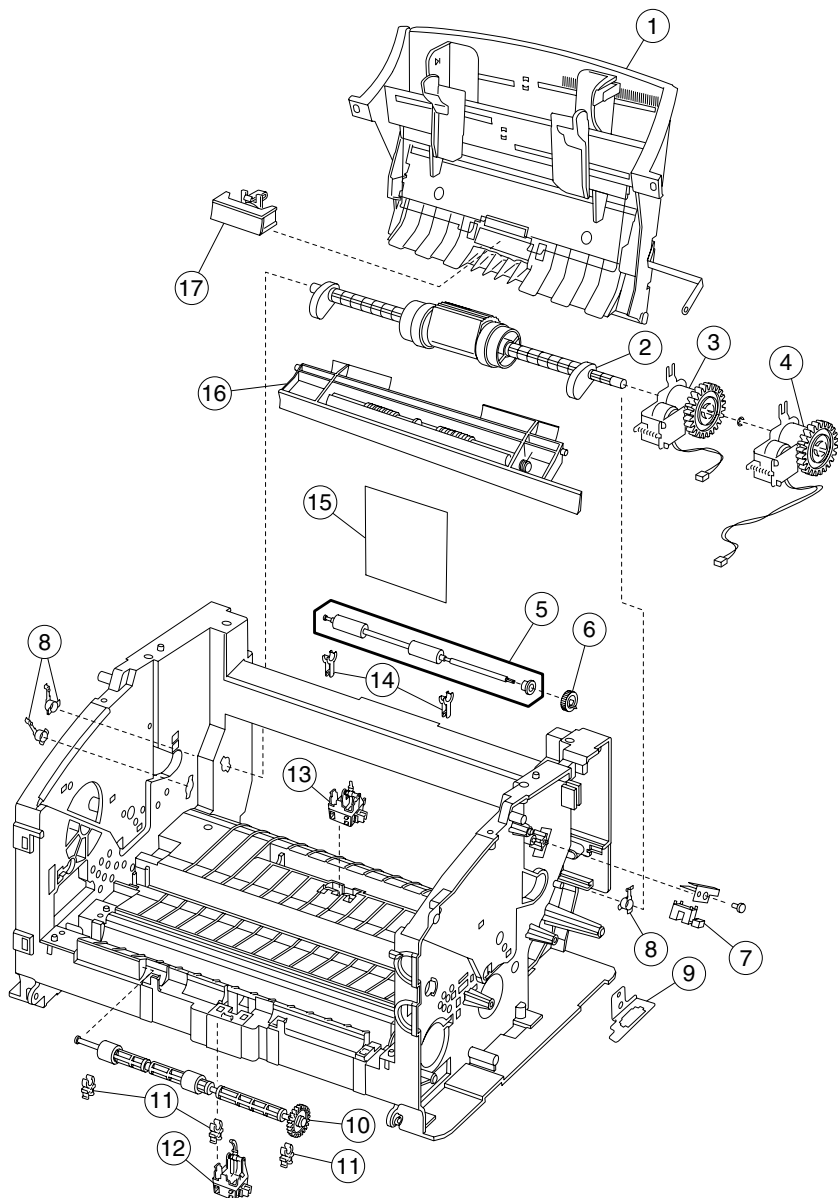

Assembly 5: Paper feed

Asm-index	Part number	Units	Description
5-1	12G4481	1	Assembly, sheet feed (white)
1	56P1079	1	Assembly, sheet feed (black)
2	12G4483	1	Assembly, D-roll (E320/E322 only)
2	56P0690	1	Assembly, D-roll (E220/E321/E323 only)
3	12G4541	1	Clutch assembly, paper feed (E320/E322 only)
4	56P1063	1	Clutch assembly, paper feed (E220/E321/E323 only)
5	12G4538	1	Roller, lower registration
6	12G4540	1	Gear, registration roller
7	12G4477	1	Sensor, cartridge
8	56P1099	1	Parts pack, bushings/clip/spring
9	12G4482	1	Bracket, Tray 2 connector
10	12G4490	1	Roll, paper feed
11	56P1099	1	Parts pack, bushings/clip/spring
12	12G4476	1	Sensor, exit
13	12G4475	1	Sensor, registration
14	12G4539	2	Bushing, registration roller
15	12G4480	1	Strip, D-roll
16	12G4474	1	Roll assembly, registration
17	56P0691	1	Pad assembly, paper separator

Assembly 6: Printhead

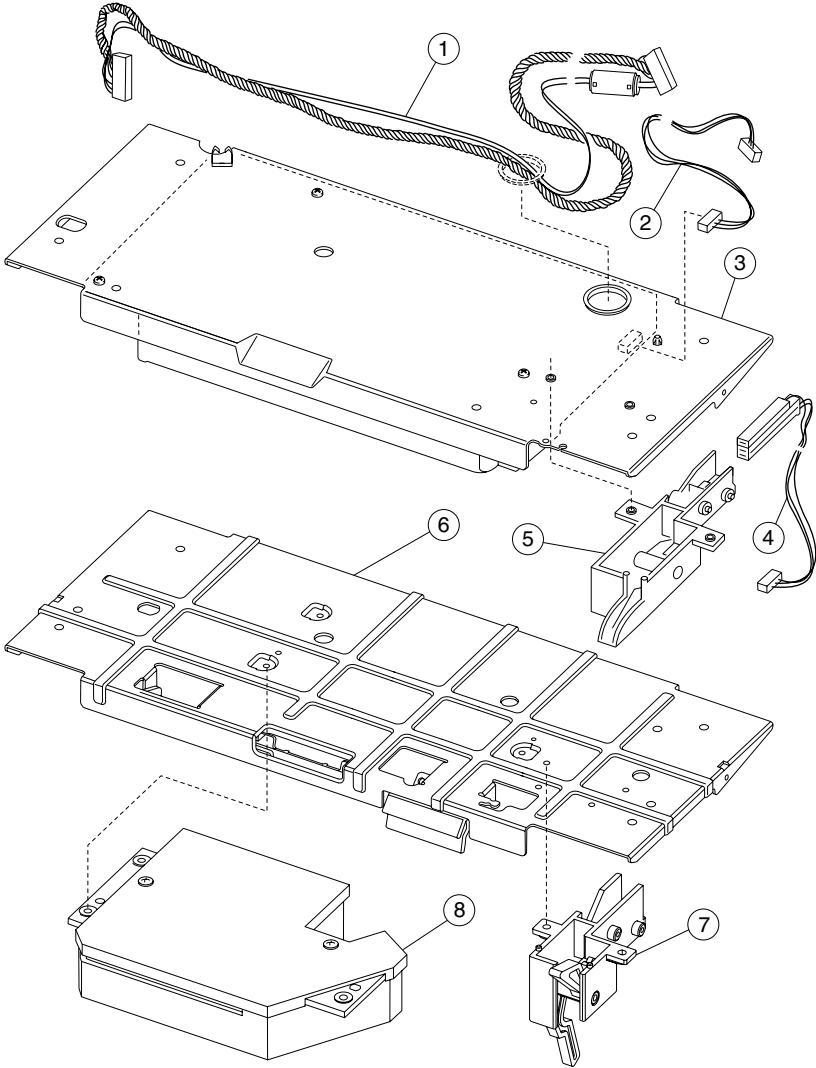

Assembly 6: Printhead

Asm-index	Part number	Units	Description
6-1*	56P1061	1	Cable, LSU-J5
2*	56P1068	1	Cable, mirror motor-J7
3	56P1087	1	Assembly, printhead (E220/E321/E323 only)
4*	56P1062	1	Cable, cover open switch-J6
5*	56P1080	1	Interlock, cover (E220/E321/E323 only)
6	12G4498	1	Plate, printhead (E320/E322 only)
7	56P0686	1	Interlock, cover sensor (E320/E322 only)
8	12G4497	1	Assembly, printhead (E320/E322 only)

* Contact Lexmark for availability.

Assembly 7: Electronics

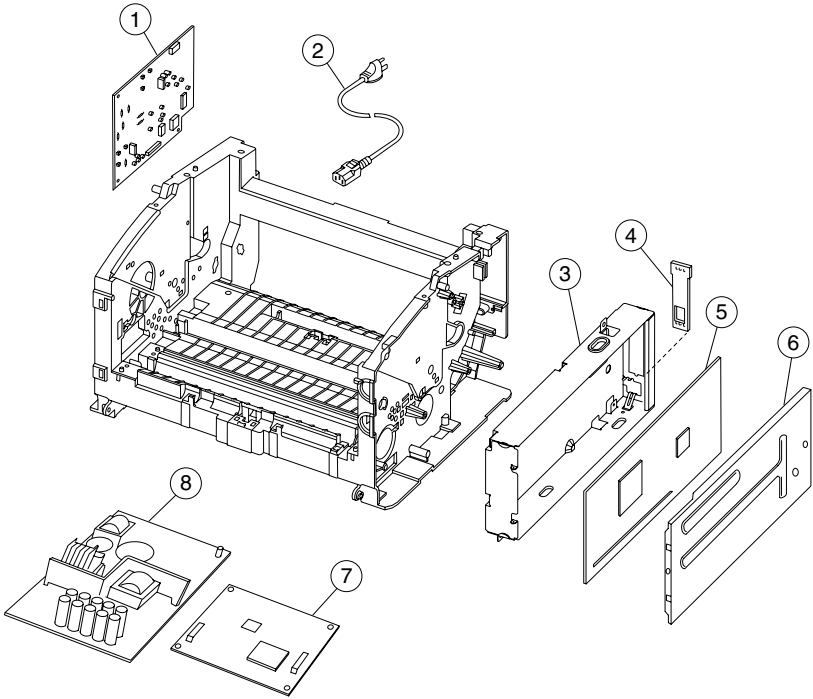

Assembly 7: Electronics

Asm-index	Part number	Units	Description
7-1	12G4509	1	Card, HVPS
2	1339526	1	Power cord, U.S., Canada, Brazil, Bolivia, Peru, Mexico, Saudi Arabia, Columbia, Costa Rica, Dominican Republic, Equador, El Salvador, Guatemala, Honduras, Nicaragua, Panama, Venezuela (HV)
2	1339528	1	Power cord, UK, Ireland, Iceland, Kuwait, Bahrein, Qatar, Oman, Pakistan, Yemen, Iraq, Libya, Cyprus
2	1339529	1	Power cord, Paraguay, Austria, Belgium, France, Netherlands, Czech, Slovak Countries, Greece, Hungary, Finland, Norway, Sweden, Germany, Lebanon, Syria, Egypt, Jordan, Iran, Bosnia, Bulgaria, Croatia, Slovenia, Macedonia, Yugoslavia, Romania, South Africa, Poland, Russia, Turkey, Spain, Catalan, Portugal
2	1339530	1	Power cord, Israel
2	1339531	1	Power cord, Switzerland
2	1339532	1	Power cord, South Africa
2	1339533	1	Power cord, Chile, Uruguay, Italy
2	1339534	1	Power cord, Denmark
3	12G4504	1	Cage, controller (E320/E322 only)
3*	56P1055	1	Cage, controller (E220/E321/E323 only)
4	56P0187	1	Bracket, Hn controller card (E320/E322 only)
4	56P1067	1	Bracket, Hn controller card (E220/E321/E323 only)

* Contact Lexmark for availability.

Assembly 7 (cont.):

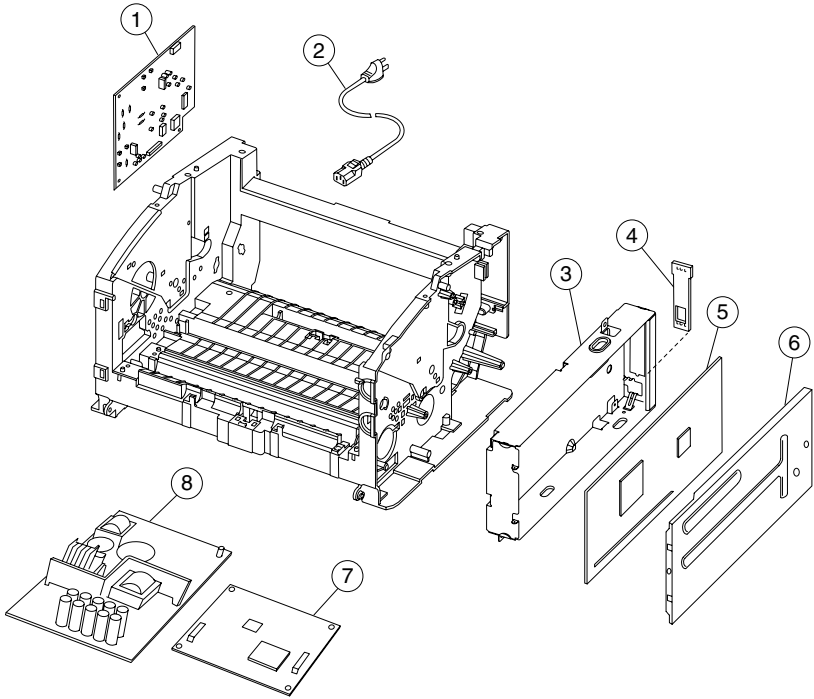

Assembly 7 (cont.): Electronics

Asm-index	Part number	Units	Description
5	12G4501	1	Card, controller E320
5	12G4502	1	Card, controller E322
5	12G4503	1	Card, controller E322 network
5	56P1071	1	Card, controller E220/E321
5	56P1073	1	Card, controller E323
5	56P1074	1	Card, controller E323 network
6	12G4505	1	Cover, cage (E320/E322 only)
6*	56P1056	1	Cover, cage (E220/E321/E323 only)
7	12G4506	1	Card, engine (E320/E322 only)
8	12G4507	1	Card, LVPS 110 V (E320/E322 only)
8	12G4508	1	Card, LVPS 220 V (E320/E322 only)
8	56P1097	1	Card, LVPS 110 V (E220/E321/E323 only)
8	56P1098	1	Card, LVPS 220 V (E220/E321/E323 only)

* Contact Lexmark for availability.

Assembly 8: Options

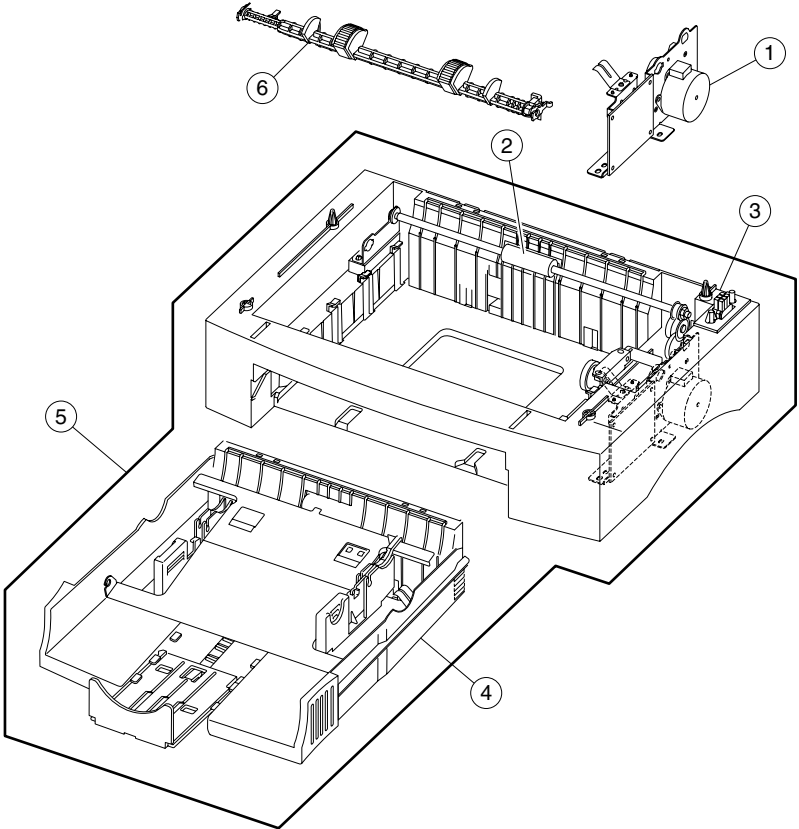

Assembly 8: Options

Asm-index	Part number	Units	Description
Models E320/E322			
8-1	12G4516	1	Board, motor, Tray 2 (E320/E322 only)
2	12G4515	1	Kit assembly, feed roller
3	12G4514	1	Base assembly, Tray 2
4	12G4513	1	Drawer, Tray 2 (white)
6	12G4532	1	D-roll, feed, Tray 2
Models E220/E321/E323 (black)			
2	12G4515	1	Kit assembly, feed roller
4	56P1090	1	Tray, Tray 2
5	56P1089	1	Base asm., Tray 2 complete
6	12G4532	1	D-roll, feed, Tray 2
Models E220/E321/E323 (white)			
2	12G4515	1	Kit assembly, feed roller
4	12G4513	1	Drawer, Tray 2
5	56P1066	1	Base asm., Tray 2 complete
6	12G4532	1	D-roll, feed, Tray 2
All models (exceptions noted)			
NS	56P0589	1	Cover, Tray 2 media
NS	99A1752	1	4MB SDRAM SIMM (E322 only)
NS	56P0695	1	8MB SDRAM DIMM
NS	56P0696	1	16MB SDRAM DIMM
NS	56P0697	1	32MB SDRAM DIMM
NS	56P0698	1	64MB SDRAM DIMM
NS	99A1757	1	2MB Flash DIMM (E323 only)
NS	99A1758	1	4MB Flash DIMM (E323 only)
NS	99A1759	1	8MB Flash DIMM (E323 only)
NS	99A1774	1	16MB Flash DIMM (E323 only)

Assembly 8 (cont.): Options

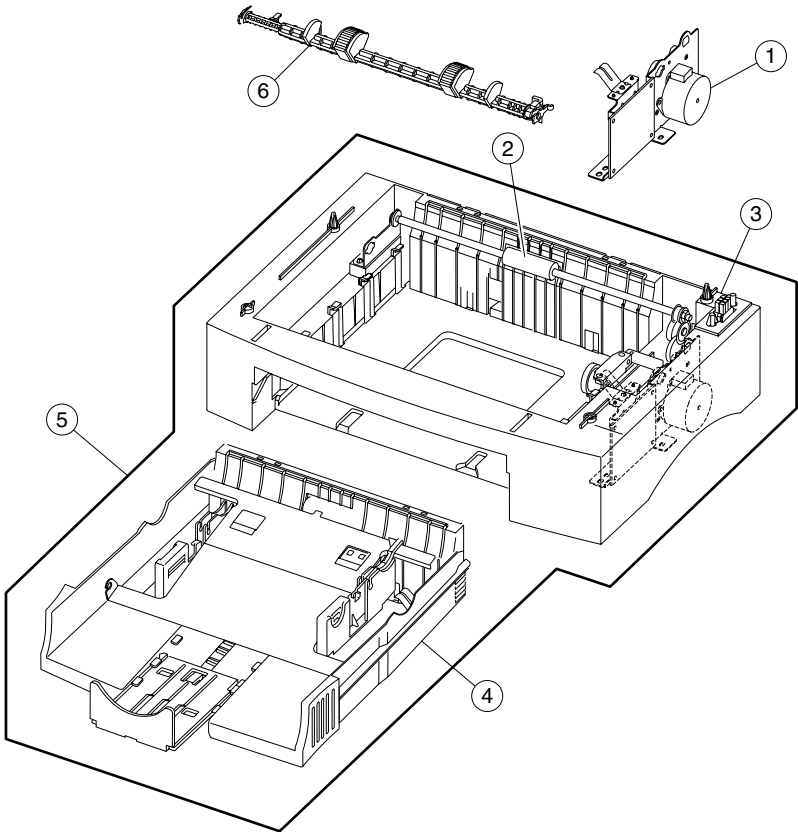

Assembly 8 (cont.): Options

Asm-index	Part number	Units	Description
NS	99A1683	1	Optra Forms™ 2MB Flash DIMM (E323 only)
NS	99A1684	1	Optra Forms 4MB Flash DIMM (E323 only)
NS	99A1685	1	Optra Forms 8MB Flash DIMM (E323 only)
NS	99A1686	1	Optra Forms 16MB Flash DIMM (E323 only)
NS	12G9833	1	MarkNet™ X2011e Ethernet 10/100Base TX
NS	12G9832	1	MarkNet X2012e Ethernet 10/100Base TX/10Base2 – 1 port
NS	12G9831	1	MarkNet X2031e Ethernet 10/100Base TX – 3 ports
NS	12G9830	1	MarkNet X2030t Token–Ring–3 ports
NS	99A0521	1	1MB Flash SIMM (E322 only)
NS	99A0522	1	2MB Flash SIMM (E322 only)
NS	99A0523	1	4MB Flash SIMM (E322 only)

Assembly 9: Cables

Asm-index	Part number	Units	Description
E320/E322 only			
NS	12G4517	1	Cable, HVPS-J1
NS	12G4518	1	Cable, input/exit sensor-J2
NS	12G4519	1	Cable, smart-J3
NS	12G4520	1	Cable, motor-J5
NS	12G4521	1	Cable, toner sensor-J6
NS	12G4522	1	Cable, controller-J11
NS	12G4523	1	Cable, option-J13
NS	12G4524	1	Cable, fuser lamp
NS	12G4525	1	Cable, ground wire
NS	12G4526	1	Cable, option
NS	12G4527	1	Cable, cover open switch-J9
NS	12G4528	1	Cable, AC receptacle
NS	12G4545	1	Cable, PSU-J12
E220/E321/E323 only			
NS*	56P1057	1	Cable, HVPS-J3
NS*	56P1058	1	Cable, input/exit sensor-J11
NS8	56P1059	1	Cable, smart IC-J13
NS*	56P1060	1	Cable, motor-J8
NS*	56P1061	1	Cable, LSU-J5
NS*	56P1062	1	Cable, cover open switch-J6
NS*	56P1068	1	Cable, mirror motor-J7
NS*	56P1069	1	Cable, LVPS-J1
NS*	56P1081	1	Cable, toner sensor-J4
NS*	56P1088	1	Cable, option tray-J15
NS*	56P0650	1	Cable, fuser lamp

* Contact Lexmark for availability.

Assembly 10: Miscellaneous

Asm-index	Part number	Units	Description
NS	12G4529	1	Ring, CS
NS	12G4530	1	Clamp, mini
NS	12G4531	1	Parts pack, screws
NS	7371901	1	Kit, field relocation
NS	56P1099	1	Parts pack, bushing/clip/spring
NS	56P1070	1	Overlay group, non-English overlays

Index

A

- acronyms 1-7
- adjustment
 - print registration (E320/E322) 3-20
 - printhead assembly 4-2
- auto CRLF/LFCR (E320/E322) 3-31

B

- board connectors (E320/E322) 5-2

C

- configuration menu (E220/E321/E323) 3-36
 - changing settings 3-37
 - moving around the menu 3-36
 - printer diagnostics 3-39
 - printer setting configuration 3-38
 - printing graphical aids 3-37
- configuration mode (E320/E322)
 - auto CRLF/LFCR 3-31
 - data streams 3-28
 - demo mode active/inactive 3-20
 - entering 3-14, 3-16
 - factory defaults 3-20
 - reset 3-21
 - font samples 3-19
 - Hex Trace 3-21
 - interface cables 3-34
 - operator panel reset 3-19
 - parallel mode 2 3-26
 - parallel NPA 3-24
 - parallel port 3-23
 - parallel protocol 3-25
 - parallel strobe 3-27
 - PPDS active/inactive 3-29
 - print directory 3-19
 - print quality test pages 3-22
 - printer buffer 3-19
 - registration adj. (E320/E322) 3-20
 - summary table 3-18
 - USB NPA mode 3-33
 - USB port 3-32

- connector locations 5-1
 - engine board (E320/E322) 5-2
 - HVPS 5-2
 - LVPS 5-1
 - option card (E320/E322) 5-11
 - RIP controller (E220/E321/E323) 5-7
 - RIP controller (E320/E322) 5-6
 - wiring diagram (E220/E321/E323) 5-12
- cover removals 4-4
 - access cover 4-4
 - front cover 4-4
 - left side cover 4-5
 - right side cover 4-5
 - top cover 4-4

D

- data streams (E320/E322) 3-28
- definitions 1-xxii
- demo mode (E320/E322) 3-20
- demo print mode (E320/E322) 3-7
- diagnostic aids 3-1
 - E220/E321/E323 3-35
 - configuration menu 3-36
 - diagnostic menu 3-36
 - operator panel
 - menu definition 3-35
 - printer diagnostics mode 3-40
 - E320/E322 3-1
 - configuration mode 3-14
 - entering 3-16
 - summary table 3-18
 - information priority 3-1
 - performing self test 3-1

- printer modes table 3-3
 - configuration 3-5
 - demo printing 3-4, 3-7
 - diagnostic tests mode 3-9
 - diagnostics tests 3-4
 - menu settings page 3-8
 - normal printing 3-3, 3-6
 - special function menu 3-5, 3-11
- printer operation modes 3-2
- diagnostic information
 - E220/E321/E323 2-35
 - E320/E322 2-1
 - service error codes 2-11
- diagnostic menu (E220/E321/E323) 3-36
 - changing settings 3-37
 - graphical aids 3-37
 - moving around the menu 3-36
 - printer diagnostics 3-39
 - printer setting configuration 3-38
- diagnostic tests (E320/E322) 3-10

E

- engine clean cycle (E320/E322) 3-13
- entering special function menu 3-11
- ESD-sensitive parts 4-1

F

- factory defaults (E320/E322) 3-20
 - reset 3-21
- font samples (E320/E322) 3-19

H

- handling ESD-sensitive parts 4-1
- Hex Trace 3-5
- Hex Trace mode
 - using (E220/E321/E323) 2-102
- Hex Trace mode (E320/E322) 3-21
- how to use parts catalog 7-1
- HVPS connector locations 5-2

I

- information priority (E320/E322) 3-1
- interface cables (E320/E322) 3-34
- invalid code
 - secondary lights 2-40

L

- laser notices 1-vii
- light patterns
 - paper jam secondary 2-40
 - printer error secondary 2-41
 - service error secondary 2-43
 - service information 2-42
- lubrication 4-3
- LVPS connector locations 5-1

M

- menu settings page (E320/E322) 3-8
- model
 - clearance 1-5
 - differences 1-4
 - dimensions 1-5
 - options 1-6

N

- normal print mode (E320/E322) 3-6

O

- operator panel
 - button service check 2-78
 - service checks 2-79
- operator panel (E220/E321/E323) 3-35
 - diagnostics 2-36
 - light patterns 2-37
 - service information 2-42
 - status information 2-38

- operator panel (E320/E322) 2-2
 - attendance information 2-4
 - host interface error 2-5
 - paper jam 2-4
- error code table 2-26
- LED table 2-25
 - primary error codes 2-30
 - secondary codes 2-28
 - subcode
 - fuser 2-31
 - toner is low 2-27
- reset 3-19
- reset defaults 3-13
- status information 2-3
 - ready 2-3
- option card connectors (E320/E322) 5-11
- options 1-6

P

- paper jam secondary lights 2-40
- parallel mode 2 (E320/E322) 3-26
- parallel NPA mode (E320/E322) 3-24
- parallel port (E320/E322) 3-23
- parallel protocol (E320/E322) 3-25
- parallel strobe (E320/E322) 3-27
- parts catalog
 - covers 7-2
 - electronics 7-18
 - frame 7-8
 - fuser 7-10
 - how to use parts catalog 7-1
 - main drive 7-12
 - miscellaneous 7-27
 - options 7-22
 - paper feed 7-14
 - printhead 7-16
- performing self test (E320/E322) 3-1
- POST symptoms 2-32, 2-60
- power-on operations 2-59
- power-on self test (POST) 2-32, 2-60
- PPDS (E320/E322) 3-29
- preventive maintenance 6-1
- print directory (E320/E322) 3-19

- print quality problems
 - solving 2-92
- print quality test pages
 - using 2-103, 2-104
- printer buffer (E320/E322) 3-19
- printer diagnostics mode (E220/E321/E323) 3-40
- printer error secondary lights 2-41
- printer mode (E320/E322)
 - configuration 3-5
 - demo 3-4, 3-7
 - diagnostic tests 3-9
 - entering 3-10
 - diagnostics menu 3-4
 - normal 3-3, 3-6
 - print menu settings page 3-8
 - special function menu 3-5, 3-11
 - table 3-3

- printer operation 1-5
- printer operation modes (E320/E322) 3-2
- printer settings (E320/E322)
 - configuration mode 3-14
- printer symptom table 2-33, 2-61
- printhead
 - adjustment 4-2

R

- removal procedures 4-4
 - auto sheet feed asm. 4-5
 - charge roll asm. 4-6
 - controller card 4-7
 - controller card cage 4-7
 - cooling fan 4-8
 - cover removals 4-4
 - D-roll 4-9
 - engine board 4-9
 - fuser assembly 4-10
 - HPVS 4-10
 - LVPS 4-11
 - operator panel 4-11
 - paper feed clutch solenoid 4-12
 - printhead asm 4-13
 - transfer roll 4-13

4500

reset

- defaults (E320/E322) 3-13
- operator panel 3-19
- user defaults (E320/E322) 2-100

RIP connectors (E220/E321/E323) 5-7

RIP connectors (E320/E322) 5-6

S

safety information 1-xvii

service checks

- controller card (E220/E321/E323)
2-67

- cooling fan (E220/E321/E323)
2-66

- cooling fan (E320/E322) 2-65

- cover interlock (E220/E321/E323)
2-70

- cover interlock (E320/E322) 2-69

- dead machine 2-71

- engine board (E320/E322) 2-72

- fuser 2-74

- cold fuser 2-64

- hot fuser 2-76

- LVPS power supply 2-76

- main motor 2-77

- operator panel 2-79

- operator panel button 2-78

- paper feed 2-81

- paper jam during POST 2-81

- paper jam-registration roll 2-84

- paper never picks 2-83

- paper picks but stops 2-82

- paper picks during POST 2-81

- paper picks sheets 2-83

- paper skews 2-84

- paper trees, curls 2-84

- parallel port 2-85

- print quality 2-86

- image density 2-89

- light print 2-90

- partial blank image 2-89

- poor fusing of image 2-90

- toner on back of page 2-91

- white or black lines 2-91

- transfer roll 2-99

service error codes 2-11, 2-45

- controller card error 2-55

- controller software error 2-45

- controller software/illegal trap 2-45

- engine circuitry error 2-53

- engine flash error 2-46

- engine software error 2-46

- fan stalled error 2-49

- fuser error 2-48

- network error 2-57

- NVRAM failure 2-54

- paper communication failure 2-58

- primary 2-8

- ASIC register failure 2-20

- ASIC SRAM failure 2-21

- base memory 2-18

- conditions not reported 2-24

- engine failure 2-24

- errors not reported 2-24

- flash memory failure 2-22

- font checksum failure 2-23

- fuser failure-over temp. 2-12

- fuser failure-printing 2-13

- fuser failure-standby 2-13

- fuser failure-under temp. 2-12

- fuser-thermistor open 2-14

- mirror motor failure 2-15

- NVRAM failure 2-19

- optional memory 2-16

- ROM checksum failure 2-17

- printhead error 2-50

- RAM memory error 2-56

- RIP to engine error 2-51, 2-52

- secondary 2-9

- software 2-11

- subcode 2-10

- toner sensor error 2-49

- transfer roll error 2-47

- transport motor error 2-51

- service error secondary lights 2-43

- service information lights 2-42

special function menu (E220/E321/
E323)

using 2-106

special function menu (E320/E322)

3-11

engine clean cycle 3-13

light summary table 3-12

operator panel 3-13

using 2-105

status information lights 2-38

symptom tables 2-32, 2-60

POST 2-32, 2-60

printer 2-33, 2-61

T

test pages

print quality (E320/E322) 3-22

U

USB NPA mode (E320/E322) 3-33

USB port (E320/E322) 3-32

W

wiring diagram (E220/E321/E323)

5-12

Part number index

P/n	Description	Page
12G0176	Cover, media	7-3, 7-7
12G4450	Cover, access	7-3
12G4450	Cover, access (white)	7-5
12G4451	Cover, left side	7-3
12G4451	Cover, left side (white)	7-7
12G4452	Cover, top	7-3
12G4452	Cover,top (white)	7-7
12G4453	Cover, right side	7-3
12G4455	Cover, rear	7-3
12G4455	Cover, rear (white)	7-5
12G4456	Extension, tray	7-3
12G4456	Extension, tray (white)	7-5
12G4457	Assembly, operator panel	7-3
12G4458	Cover, bottom	7-3, 7-5
12G4459	Duct, cooling	7-3
12G4459	Duct, cooling (white)	7-5
12G4460	Fan, cooling (E320/E322 only)	7-9
12G4461	Switch asm., power (white 110 V)	7-9
12G4463	Spring, charge roll left	7-9
12G4464	Spring, charge roll right	7-9
12G4470	Roll, transfer	7-9
12G4471	Bearing, transfer	7-9
12G4473	B/M, rail (E320/E322 only)	7-9
12G4474	Roll assembly, registration	7-15
12G4475	Sensor, registration	7-15
12G4476	Sensor, exit	7-15
12G4477	Sensor, cartridge	7-15
12G4480	Strip, D-roll	7-15
12G4481	Assembly, sheet feed (white)	7-15
12G4482	Bracket, tray 2 connector	7-15
12G4483	Assembly, D-roll (E320/E322 only)	7-15
12G4484	Fuser assembly, 110 V (E320/E322 only)	7-11
12G4485	Lamp, fuser, 110 V	7-11
12G4486	Fuser assembly, 220 V (E320/E322 only)	7-11

4500

12G4487	Lamp, fuser, 220 V	7-11
12G4488	Cover, fuser (E320/E322 only)	7-11
12G4489	Bearing, backup roll	7-11
12G4490	Roll, paper feed	7-15
12G4491	Roll, fuser, hot	7-11
12G4492	Roller, exit, idler (1 each)	7-11
12G4493	Roller, exit, redrive	7-11
12G4494	Roll, fuser, backup	7-11
12G4495	Pawl, detack (1 each)	7-11
12G4496	Roll assembly, idler (1 each)	7-11
12G4497	Assembly, printhead (E320/E322 only)	7-17
12G4498	Plate, printhead (E320/E322 only)	7-17
12G4499	Motor, drive (E320/E322 only)	7-13
12G4500	Gear assembly, drive (E320/E322)	7-13
12G4501	Card, controller E320	7-21
12G4502	Card, controller E322	7-21
12G4503	Card, controller E322 network	7-21
12G4504	Cage, controller (E320/E322 only)	7-19
12G4505	Cover, cage (E320/E322 only)	7-21
12G4506	Card, engine (E320/E322 only)	7-21
12G4507	Card, LVPS 110 V (E320/E322 only)	7-21
12G4508	Card, LVPS 220 V (E320/E322 only)	7-21
12G4509	Card, HVPS	7-19
12G4510	Spring, HVPS (6/FRU)	7-9
12G4513	Drawer, Tray 2	7-23
12G4513	Drawer, Tray 2 (white)	7-23
12G4514	Base assembly, Tray 2	7-23
12G4515	Kit assembly, feed roller	7-23
12G4516	Board, motor, tray 2 (E320/E322 only)	7-23
12G4517	Cable, HVPS-J1	7-26
12G4518	Cable, input/exit sensor-J2	7-26
12G4519	Cable, smart-J3	7-26
12G4520	Cable, motor-J5	7-26
12G4521	Cable, toner sensor-J6	7-26
12G4522	Cable, controller-J11	7-26
12G4523	Cable, option-J13	7-26
12G4524	Cable, fuser lamp	7-26
12G4525	Cable, ground wire	7-26
12G4526	Cable, option	7-26

12G4527	Cable, cover open switch-J9	7-26
12G4528	Cable, AC receptacle	7-26
12G4529	Ring, CS	7-27
12G4530	Clamp, mini	7-27
12G4531	Parts pack, screws	7-27
12G4532	D-roll, feed, Tray 2	7-23
12G4533	Bracket, left	7-9
12G4534	Bracket, right	7-9
12G4535	Spring, front cover right	7-3, 7-5
12G4536	Spring, front cover left	7-3, 7-5
12G4538	Roller, lower registration	7-15
12G4539	Bushing, registration roller	7-15
12G4540	Gear, registration roller	7-15
12G4541	Clutch assembly, paper feed (E320/E322 only)	7-15
12G4542	Cover, front- E322	7-3
12G4543	Cover, front- E320	7-3
12G4545	Cable, PSU-J12	7-26
12G9830	MarkNet X2030t Token-Ring-3 ports	7-25
12G9831	MarkNet X2031e Ethernet 10/100Base TX - 3 ports	7-25
12G9832	MarkNet X2012e Ethernet 10/100Base TX/10Base2 - 1 port	7-25
12G9833	MarkNet X2011e Ethernet 10/100Base TX	7-25
1339526	Power cord	7-19
1339528	Power cord	7-19
1339529	Power cord	7-19
1339530	Power cord	7-19
1339531	Power cord	7-19
1339532	Power cord	7-19
1339533	Power cord	7-19
1339534	Power cord	7-19
56P0187	Bracket, Hn controller card (E320/E322 only)	7-19
56P0199	Bearing, left transfer	7-9
56P0589	Cover, Tray 2 media	7-23
56P0650	Cable, fuser lamp	7-26
56P0683	Assembly, operator panel (white)	7-5
56P0685	Assembly, charge roll	7-9

56P0686	Interlock, cover sensor (E320/E322 only)	7-17
56P0687	Switch asm., power white 220 V)	7-9
56P0688	Switch asm., power (black 220 V)	7-9
56P0690	Assembly, D-roll (E220/E321/E323 only)	7-15
56P0691	Pad assembly, paper separator	7-15
56P0695	8MB SDRAM DIMM	7-23
56P0696	16MB SDRAM DIMM	7-23
56P0697	32MB SDRAM DIMM	7-23
56P0698	64MB SDRAM DIMM	7-23
56P1050	Cover, right side	7-5
56P1051	Assembly, operator panel	7-5
56P1052	Fan, cooling (E220/E321/E323)	7-9
56P1053	Fuser assembly, 110 V (E220/E321/E323 only)	7-11
56P1054	Fuser assembly, 220 V (E220/E321/E323 only)	7-11
56P1055	Cage, controller (E220/E321/E323 only)	7-19
56P1056	Cover, cage (E220/E321/E323 only)	7-21
56P1057	Cable, HVPS-J3	7-26
56P1058	Cable, input/exit sensor-J11	7-26
56P1059	Cable, smart IC-J13	7-26
56P1060	Cable, motor-J8	7-26
56P1061	Cable, LSU - J5	7-17
56P1061	Cable, LSU-J5	7-26
56P1062	Cable, cover open switch - J6	7-17
56P1062	Cable, cover open switch-J6	7-26
56P1063	Clutch assembly, paper feed (E220/E321/E323 only)	7-15
56P1064	Cover, front - E321	7-5
56P1065	Cover, front - E323	7-5
56P1066	Base asm., Tray 2 complete	7-23
56P1067	Bracket, Hn controller card (E220/E321/E323 only)	7-19
56P1068	Cable, mirror motor - J7	7-17
56P1068	Cable, mirror motor-J7	7-26
56P1069	Cable, LVPS-J1	7-26
56P1070	Overlay GP, non-English overlays	7-27
56P1071	Card, controller E220/E321	7-21
56P1073	Card, controller E323	7-21
56P1074	Card, controller E323 network	7-21
56P1075	Cover, access	7-5
56P1076	Cover, left side	7-7
56P1077	Cover, top	7-7
56P1078	Assembly, cover, rear	7-5

56P1079	Assembly, sheet feed (black)	7-15
56P1080	Interlock, cover (E220/E321/E323 only)	7-17
56P1081	Cable, toner sensor-J4	7-26
56P1082	Cover, fuser (E220/E321/E323 only)	7-11
56P1083	Motor, drive (E220/E321/E323)	7-13
56P1084	Cover, right side (white)	7-5
56P1085	B/M, rail (E220/E321/E323 only)	7-9
56P1086	Duct, cooling	7-5
56P1087	Assembly, printhead (E220/E321/E323 only)	7-17
56P1088	Cable, option tray-J15	7-26
56P1089	Base asm., Tray 2 complete	7-23
56P1090	Tray, Tray 2	7-23
56P1091	Assembly, paper guide with exit tray (white)	7-7
56P1092	Switch asm., power (black 110 V)	7-9
56P1094	Assembly, paper guide with exit tray (black)	7-7
56P1095	Cover, front, E321 (white)	7-5
56P1096	Cover, front, E323 (white)	7-5
56P1097	Card, LVPS 110 V (E320/E322 only)	7-21
56P1098	Card, LVPS 220 V (E320/E322 only)	7-21
56P1099	Parts pack, bushing/clip/spring	7-27
56P1099	Parts pack, bushings clip spring	7-3, 7-5
56P1099	Parts pack, bushings/clip spring	7-11
56P1099	Parts pack, bushings/clip/spring	7-15
56P1836	Cover, front - E220 (white)	7-5
56P1837	Cover, front - E220	7-5
56P1838	Assembly, operator panel (E220) (white)	7-5
56P1839	Assembly, operator panel (E220)	7-5
56P2373	Hinge, right	7-3, 7-5
56P2374	Hinge, left	7-3, 7-5
56P2441	Gear assembly, drive (E220/E321/E323)	7-13
7371901	Field relocation kit	7-27
99A0521	1MB Flash SIMM (E322 only)	7-25
99A0522	2MB Flash SIMM (E322 only)	7-25
99A0523	4MB Flash SIMM (E322 only)	7-25
99A1017	Roll, charge	7-9

99A1683	Optra Forms 2MB Flash DIMM (E323 only)	7-25
99A1684	Optra Forms 4MB Flash DIMM (E323 only)	7-25
99A1685	Optra Forms 8MB Flash DIMM (E323 only)	7-25
99A1686	Optra Forms 16MB Flash DIMM (E323 only)	7-25
99A1752	4MB SDRAM SIMM (E322 only)	7-23
99A1757	2MB Flash DIMM (E323 only)	7-23
99A1758	4MB Flash DIMM (E323 only)	7-23
99A1759	8MB Flash DIMM (E323 only)	7-23
99A1774	16MB Flash DIMM (E323 only)	7-23