



## *Service Manual*

**Lexmark 4200 Series  
All-In-One**

---

**4413-XXX**

- ***Table of Contents***
- ***Start Diagnostics***
- ***Safety and Notices***
- ***Trademarks***
- ***Index***

**LEXMARK™**

*Lexmark and Lexmark with diamond design are trademarks of Lexmark International, Inc., registered in the United States and/or other countries.*

## 4413-XXX

**Edition: March 2004**

**The following paragraph does not apply to any country where such provisions are inconsistent with local law:** LEXMARK INTERNATIONAL, INC. PROVIDES THIS PUBLICATION "AS IS" WITHOUT WARRANTY OF ANY KIND, EITHER EXPRESS OR IMPLIED, INCLUDING, BUT NOT LIMITED TO, THE IMPLIED WARRANTIES OF MERCHANTABILITY OR FITNESS FOR A PARTICULAR PURPOSE. Some states do not allow disclaimer of express or implied warranties in certain transactions; therefore, this statement may not apply to you.

This publication could include technical inaccuracies or typographical errors. Changes are periodically made to the information herein; these changes will be incorporated in later editions. Improvements or changes in the products or the programs described may be made at any time.

Comments may be addressed to Lexmark International, Inc., Department D22A/032-2, 740 West New Circle Road, Lexington, Kentucky 40550, U.S.A or e-mail at [ServiceInfoAndTraining@Lexmark.com](mailto:ServiceInfoAndTraining@Lexmark.com). Lexmark may use or distribute any of the information you supply in any way it believes appropriate without incurring any obligation to you. You can purchase additional copies of publications related to this product by calling 1-800-553-9727. In other countries, contact your point of purchase.

Lexmark and Lexmark with diamond design are trademarks of Lexmark International, Inc., registered in the United States and/or other countries.

Other trademarks are the property of their respective owners.

**© Copyright Lexmark International, Inc. 2004.**

**All rights reserved.**

### **UNITED STATES GOVERNMENT RIGHTS**

This software and any accompanying documentation provided under this agreement are commercial computer software and documentation developed exclusively at private expense.

# Table of Contents

<b>Safety information</b> .....	<b>v</b>
<b>Preface</b> .....	<b>x</b>
Definitions .....	<b>x</b>
<b>General information</b> .....	<b>1-1</b>
Specifications .....	<b>1-2</b>
Print engine .....	<b>1-2</b>
Printhead .....	<b>1-2</b>
Facsimile .....	<b>1-3</b>
Scanner .....	<b>1-4</b>
Power and size .....	<b>1-4</b>
Abbreviations .....	<b>1-5</b>
<b>Diagnostic information</b> .....	<b>2-1</b>
Start .....	<b>2-1</b>
Power-On Self Test (POST) sequence .....	<b>2-1</b>
POST symptom table .....	<b>2-2</b>
Symptom tables .....	<b>2-3</b>
Service checks .....	<b>2-6</b>
Carrier transport service check .....	<b>2-6</b>
CIS assembly service check .....	<b>2-8</b>
Scanner motor with gear assembly service check .....	<b>2-9</b>
Maintenance station service check .....	<b>2-10</b>
Paper feed service check .....	<b>2-11</b>
Paper path service check .....	<b>2-13</b>
Power service check .....	<b>2-14</b>
Print quality service check .....	<b>2-15</b>
Scan/copy quality service check .....	<b>2-17</b>
Fax/telephone communication service check .....	<b>2-18</b>
<b>Diagnostic aids</b> .....	<b>3-1</b>
Theory of mechanism .....	<b>3-1</b>
Scanner mechanism .....	<b>3-1</b>
Drive feed roller assembly .....	<b>3-1</b>
Contact Image Sensor (CIS) .....	<b>3-2</b>
Document sensors .....	<b>3-2</b>

- Repair information** .....4-1
  - Handling ESD-sensitive parts .....4-1
  - Adjustments .....4-2
  - Removal procedures .....4-2
    - Releasing plastic latches .....4-2
  - Removals .....4-3
    - General precautions on removals .....4-3
    - CIS white roller assembly removal.....4-4
    - Top cover assembly removal .....4-5
    - Rollers (drive feed roller assembly, exit shaft) removal .....4-6
    - CIS (Contact Image Sensor) removal .....4-10
    - Scanner motor with gear assembly removal .....4-11
    - Control panel assembly removal .....4-13
    - Print engine removal .....4-16
    - Maintenance station removal .....4-17
    - Carrier assembly with belt removal .....4-18
    - System board removal .....4-19
    - Exit rollers removal.....4-20
    - Large feed roller assembly with gear removal .....4-21
    - Paper feed motor assembly with gears removal .....4-23
    - Carrier transport motor removal.....4-24
    - Handset and cradle removal .....4-24
- Connector locations** .....5-1
  - System board.....5-1
- Preventive maintenance** .....6-1
  - Lubrication specifications .....6-1
- Parts catalog** .....7-1
  - How to use this parts catalog .....7-1
- Index** ..... I-1

---

## Safety information

- The safety of this product is based on testing and approvals of the original design and specific components. The manufacturer is not responsible for safety in the event of use of unauthorized replacement parts.
- The maintenance information for this product has been prepared for use by a professional service person and is not intended to be used by others.
- There may be an increased risk of electric shock and personal injury during disassembly and servicing of this product. Professional service personnel should understand this and take necessary precautions.
-  **CAUTION:** When you see this symbol, there is a danger from hazardous voltage in the area of the product where you are working. Unplug the product before you begin, or use caution if the product must receive power in order to perform the task.

---

## Consignes de sécurité

- La sécurité de ce produit repose sur des tests et des agréments portant sur sa conception d'origine et sur des composants particuliers. Le fabricant n'assume aucune responsabilité concernant la sécurité en cas d'utilisation de pièces de rechange non agréées.
- Les consignes d'entretien et de réparation de ce produit s'adressent uniquement à un personnel de maintenance qualifié.
- Le démontage et l'entretien de ce produit pouvant présenter certains risques électriques, le personnel d'entretien qualifié devra prendre toutes les précautions nécessaires.
-  **ATTENTION :** Ce symbole indique la présence d'une tension dangereuse dans la partie du produit sur laquelle vous travaillez. Débranchez le produit avant de commencer ou faites preuve de vigilance si l'exécution de la tâche exige que le produit reste sous tension.

---

## Norme di sicurezza

- La sicurezza del prodotto si basa sui test e sull'approvazione del progetto originale e dei componenti specifici. Il produttore non è responsabile per la sicurezza in caso di sostituzione non autorizzata delle parti.
- Le informazioni riguardanti la manutenzione di questo prodotto sono indirizzate soltanto al personale di assistenza autorizzato.
- Durante lo smontaggio e la manutenzione di questo prodotto, il rischio di subire scosse elettriche e danni alla persona è più elevato. Il personale di assistenza autorizzato deve, quindi, adottare le precauzioni necessarie.
-  **ATTENZIONE:** Questo simbolo indica la presenza di tensione pericolosa nell'area del prodotto. Scollegare il prodotto prima di iniziare o usare cautela se il prodotto deve essere alimentato per eseguire l'intervento.

---

## Sicherheitshinweise

- Die Sicherheit dieses Produkts basiert auf Tests und Zulassungen des ursprünglichen Modells und bestimmter Bauteile. Bei Verwendung nicht genehmigter Ersatzteile wird vom Hersteller keine Verantwortung oder Haftung für die Sicherheit übernommen.
- Die Wartungsinformationen für dieses Produkt sind ausschließlich für die Verwendung durch einen Wartungsfachmann bestimmt.
- Während des Auseinandernehmens und der Wartung des Geräts besteht ein zusätzliches Risiko eines elektrischen Schlags und körperlicher Verletzung. Das zuständige Fachpersonal sollte entsprechende Vorsichtsmaßnahmen treffen.
-  **ACHTUNG:** Dieses Symbol weist auf eine gefährliche elektrische Spannung hin, die in diesem Bereich des Produkts auftreten kann. Ziehen Sie vor den Arbeiten am Gerät den Netzstecker des Geräts, bzw. arbeiten Sie mit großer Vorsicht, wenn das Produkt für die Ausführung der Arbeiten an den Strom angeschlossen sein muß.

---

## Pautas de Seguridad

- La seguridad de este producto se basa en pruebas y aprobaciones del diseño original y componentes específicos. El fabricante no es responsable de la seguridad en caso de uso de piezas de repuesto no autorizadas.
- La información sobre el mantenimiento de este producto está dirigida exclusivamente al personal cualificado de mantenimiento.
- Existe mayor riesgo de descarga eléctrica y de daños personales durante el desmontaje y la reparación de la máquina. El personal cualificado debe ser consciente de este peligro y tomar las precauciones necesarias.
-  **PRECAUCIÓN:** este símbolo indica que el voltaje de la parte del equipo con la que está trabajando es peligroso. Antes de empezar, desenchufe el equipo o tenga cuidado si, para trabajar con él, debe conectarlo.

---

## Informações de Segurança

- A segurança deste produto baseia-se em testes e aprovações do modelo original e de componentes específicos. O fabricante não é responsável pela segurança, no caso de uso de peças de substituição não autorizadas.
- As informações de segurança relativas a este produto destinam-se a profissionais destes serviços e não devem ser utilizadas por outras pessoas.
- Risco de choques eléctricos e ferimentos graves durante a desmontagem e manutenção deste produto. Os profissionais destes serviços devem estar avisados deste facto e tomar os cuidados necessários.
-  **CUIDADO:** Quando vir este símbolo, existe a possível presença de uma potencial tensão perigosa na zona do produto em que está a trabalhar. Antes de começar, desligue o produto da tomada eléctrica ou seja cuidadoso caso o produto tenha de estar ligado à corrente eléctrica para realizar a tarefa necessária.

## Informació de Seguretat

- La seguretat d'aquest producte es basa en l'avaluació i aprovació del disseny original i els components específics. El fabricant no es fa responsable de les qüestions de seguretat si s'utilitzen peces de recanvi no autoritzades.
- La informació pel manteniment d'aquest producte està orientada exclusivament a professionals i no està destinada a ningú que no ho sigui.
- El risc de xoc elèctric i de danys personals pot augmentar durant el procés de desmuntatge i de servei d'aquest producte. El personal professional ha d'estar-ne assabentat i prendre les mesures convenients.
-  **PRECAUCIÓ:** aquest símbol indica que el voltatge de la part de l'equip amb la qual esteu treballant és perillós. Abans de començar, desendolieu l'equip o extremeu les precaucions si, per treballar amb l'equip, l'heu de connectar.

## 안전 사항

- 본 제품은 원래 설계 및 특정 구성품에 대한 테스트 결과로 안정성이 입증된 것입니다. 따라서 무허가 교체부품을 사용하는 경우에는 제조업체에서 안전에 대한 책임을 지지 않습니다.
- 본 제품에 관한 유지 보수 설명서는 전문 서비스 기술자용으로 작성된 것이므로, 비전문가는 사용할 수 없습니다.
- 본 제품을 해체하거나 정비할 경우, 전기적인 충격을 받거나 상처를 입을 위험이 커집니다. 전문 서비스 기술자는 이 사실을 숙지하고, 필요한 예방 조치를 취하도록 하십시오.
-  **주의:** 이 표시는 해당영역에서 고압전류가 흐른다는 위험 표시입니다. 시작전에 플러그를 뽑으시거나, 주의를 기울여 주시기 바랍니다.



---

## 安全信息

本产品的安全性以原来设计和特定产品的测试结果和认证为基础。万一使用未经许可的替换部件，制造商不对安全性负责。

本产品的维护信息仅供专业服务人员使用，并不打算让其他人使用。

本产品在拆卸、维修时，遭受电击或人员受伤的危险性会增高，专业服务人员对这点必须有所了解，并采取必要的预防措施。



**切记：**当您看到此符号时，说明在您工作的产品区域有危险电压的存在。请在开始操作前拔掉产品的电源线，或者在产品必须使用电源来执行任务时，小心从事。

---

## Preface

This manual contains maintenance procedures for service personnel. It is divided into the following chapters:

1. **General information** contains a general description of the printer and the maintenance approach used to repair it. Special tools and test equipment are listed in this chapter, as well as general environmental and safety instructions.
2. **Diagnostic information** contains an error indicator table, symptom tables, and service checks used to isolate failing field replaceable units (FRUs).
3. **Diagnostic aids** contains tests and checks used to locate or repeat symptoms of printer problems.
4. **Repair information** provides instructions for making printer adjustments and removing and installing FRUs.
5. **Connector locations** uses illustrations to identify the connector locations and test points on the printer.
6. **Preventive maintenance** contains the lubrication specifications and recommendations to prevent problems.
7. **Parts catalog** contains illustrations and part numbers for individual FRUs.

---

## Definitions

**Note:** A note provides additional information.

**Warning:** A warning identifies something that might damage the product hardware or software.

**CAUTION:** A caution identifies something that might cause a servicer harm.



**CAUTION:** When you see this symbol, there is a danger from hazardous voltage in the area of the product where you are working. Unplug the product before you begin, or use caution if the product must receive power in order to perform the task.

# 1. General information

The Lexmark™ 4200 Series All-In-One (4413-XXX) is a letter quality print, fax, copy, and scan machine. It is a standalone color/mono copier and fax. The printhead uses small heater plates and nozzles to control ink flow and the formation of characters on the print media. The printhead assembly and ink supply are combined into a single unit. Print cartridges are available as a customer replaceable supply item. Dual printheads provide color and true black printing without changing printheads. The number and size of inkjets or nozzles, in the printhead, determines the overall quality and capability of the printer. The black cartridge has a total of 208 nozzles and installs on the right. The color cartridge has a total of 192 nozzles and installs on the left. The printer is capable of printing in both directions from either cartridge.

4250	4270
4413-K01	4413-K03
4413-AK1 (DBCS)	4413-AK3 (DBCS)
No handset	Handset



4250



4270

## Specifications

### Print engine

Technology		Thermal Inkjet
		2-pin and printhead swapping type
Speed	Color	10 ppm at Draft Mode
	Mono	17 ppm at Draft Mode
Resolution	Color/Mono	Quick Print: 300 x 600 dpi Normal: 600 x 600 dpi Better: 1200 x 1200 dpi Best: 4800 x 1200 dpi for photo paper Best: 2400 x 1200 dpi for other paper
Printing Width		203 mm
Feeding Method	Automatic	100 sheets of 20 lb cut sheets (Max 10 mm)
	Manual Tray	No
Emulation		Host Based Printing (GDI)
Printer Driver		Windows 98/ME, Windows 2000/Windows XP
Interface		USB Interface

### Printhead

	<b>Babbage Mono Standard</b>	<b>Birch Color</b>
Printhead	208 nozzles	192 nozzles
Ink Type	Pigment	Dye
Ink Color	Black	Color
Ink Yield	About 600 sheets	About 450 sheets

## Facsimile

General	Scan Method	CIS
	Scan Width	Maximum 216 mm, Minimum 76.2 mm
	Feeding Method	Sheet Feed
	ADF	30 sheets of 20 lb
	Guide	Document Input Guide
	Stacker	Document Output Stacker/Paper Stacker
	Paper Tray	Bin Type (without Manual Tray)
	Modem Speed	33.6 Kbps
	LCD	2 lines of 16 characters each
Scanning	Resolution	Optical Resolution: 600 dpi (H) x 1200 dpi (V) Interpolated: 9600 dpi x 9600 dpi
	Contrast	Darkest/Darken/Normal Lighten/Lightest
Telephone	Speed Dial	79 locations
	On-Hook Dial	Yes
	Last Number Redial	Yes
	Auto Redial	Yes
	Ringer Volume	S/W Option Setting (4 steps)
	Tone/Pulse Select	S/W Option Setting
	Report and List	Telephone Number List
Copy	Self Test	Yes
	Multipage Copy	Up to 99 pages
	Grayscale	256 levels
	Reduction and Enlargement	25% - 200% (Reference is the top center of document.)

## 4413-XXX

Telephone I/F	Answering I/F	Yes
	Extension Phone	1-jack, extension phone transfer
Others	Sensors	Paper Jam
	Clock	Yes

## Scanner

Compatibility	TWAIN
Technology	Platen CIS
Light Source for Color CIS	RGB LEDs (Line Order Control)

## Power and size

Power Source	100V-127V with 2-wire power cord fixed 100V-127V with 2-wire separate power cord (Japan) 220V-240V with 2-wire AC inlet separate power cord Energy Star Compliant (with 1 watt regulation)
Dimensions	440.6 X 319.6 X 205.4 mm
Weight (Packed)	15.3 lbs (Packed Weight)

## Abbreviations

AIO	All-In-One
ASF	Auto Sheet Feed
B/M	Bill of Material
CIS	Contact Image Sensor
EOF	End of Form
ESD	Electrostatic Discharge
FPC	Flat Printhead Cable
FRU	Field Replaceable Unit
GDI	Graphic Display Interface
HVPS	High Voltage Power Supply
LCD	Liquid Crystal Display
LVPS	Low Voltage Power Supply
OEM	Original Equipment Manufacturer
V ac	Volts alternating current
V dc	Volts direct current
ZIF	Zero Insertion Force

**4413-XXX**



---

## 2. Diagnostic information

---

### Start

#### Power-On Self Test (POST) sequence

1. Lexmark 4200 Series is displayed on the LCD.
2. Power, Fax, Copy, Scan and Auto Answer lights turn on.
3. Copy and Scan button lights turn on.
4. Carrier moves to the left and returns to the maintenance station.  
The paper feed motor runs then stops.
5. Enter Fax Number is displayed.
6. Date and Time display when POST is complete.

If your printer completes POST with errors, go to the **“Symptom tables” on page 2-3**. Locate the symptom and take the indicated action.

If your printer does not complete POST, locate the symptom in the following table and take the indicated action.

## POST symptom table

Symptom	Action
LCD or Control Panel buttons do not work and no motors run	Go to the <b>“Power service check” on page 2-14</b> . If okay, go to the <b>“Control panel problems” on page 2-3</b> .
Paper feed gears do not turn	Go to the <b>“Paper feed service check” on page 2-11</b> .
Carrier does not move	Go to the <b>“Carrier transport service check” on page 2-6</b> .
Carrier slams side frame	Go to the <b>“Carrier transport service check” on page 2-6</b> .
CIS light does not turn on	Go to the <b>“CIS assembly service check” on page 2-8</b> .

## Symptom tables

Locate the symptom in the following tables and take the appropriate action.

### Carrier transport problems

Symptom	Action
<ul style="list-style-type: none"> <li>• No carrier movement</li> <li>• Slow carrier movement</li> <li>• Carrier stops</li> <li>• Carrier slams side frame</li> </ul>	Go to the <b>“Carrier transport service check” on page 2-6.</b>

### Maintenance station problems

Symptom	Action
Maintenance station: <ul style="list-style-type: none"> <li>• Fails to cap the printheads</li> <li>• Fails to clean the printheads</li> </ul>	Go to the <b>“Maintenance station service check” on page 2-10.</b>

### Control panel problems

Symptom	Action
<ul style="list-style-type: none"> <li>• Buttons do not work</li> <li>• LCD does not display</li> </ul>	<p>Check control panel cable connection at CN5 on the system board. Run the <b>“Power-On Self Test (POST) sequence” on page 2-1</b>. If the LCD or buttons fail, check connection CN5. If the problem remains, replace the control panel assembly. Go to the <b>“Control panel assembly removal” on page 4-13</b>.</p> <p>If the problem still exists, replace the system board. Go to the <b>“System board removal” on page 4-19</b>.</p>

Symptom	Action
Document scan sensor does not detect document	Check control panel cable connector CN5 on the system board. If okay, go to the <b>“Scanner motor with gear assembly service check” on page 2-9</b> . If the scanner motor is working correctly, replace the control panel assembly. Go to the <b>“Control panel assembly removal” on page 4-13</b> .

### Printer communication problem

Symptom	Action
Not able to print Self Test Page	Check the USB cable and system board cable connections. If okay, replace system board. Go to the <b>“System board removal” on page 4-19</b> .

### Phone handset/cradle problem

Symptom	Action
No dial tone Handset does not work	Check all phone connections. Be sure the main phone connection is connected to the printer. Check pins 5 and 6 for approximately 3 volts on connector CN11 located on the system board. If voltage is not correct, replace the system board. Go to the <b>“System board removal” on page 4-19</b> . If problem still exists, replace the handset and cradle. Go to <b>“Handset and cradle removal” on page 4-24</b> .

**Scanner problems**

Symptom	Action
Light does not turn on	Go to the <b>“CIS assembly service check” on page 2-8.</b>
<ul style="list-style-type: none"> <li>Scanned images are faded, or colors are dull, blurry or fuzzy. Images are slanted or crooked and the straight lines in the image appear to be jagged or uneven.</li> <li>Blank copies</li> </ul>	Go to the <b>“Scan/copy quality service check” on page 2-17.</b>
<ul style="list-style-type: none"> <li>Scanner motor does not run</li> <li>Document sensor does not work</li> </ul>	<p>Go to the <b>“Scanner motor with gear assembly service check” on page 2-9.</b></p> <p>Go to the <b>“Control panel problems” on page 2-3.</b></p>
<ul style="list-style-type: none"> <li>CIS white roller assembly slips</li> <li>Paper does not feed correctly</li> </ul>	Go to the <b>“Paper path service check” on page 2-13.</b>

**Paper feed problems**

Symptom	Action
<ul style="list-style-type: none"> <li>Fails to pick paper</li> <li>Picks more than one sheet of paper</li> <li>Picks paper but fails to feed</li> <li>Paper jams</li> <li>Paper fails to exit</li> <li>Noisy paper feed</li> </ul>	Go to the <b>“Paper feed service check” on page 2-11.</b>
Envelopes fail to feed	Go to the <b>“Paper feed service check” on page 2-11.</b>
Paper skews	Go to the <b>“Paper path service check” on page 2-13.</b>

## Power problems

Symptom	Action
No power in machine, motors do not operate	Go to the <b>“Power service check” on page 2-14.</b>

## Print quality problems

Symptom	Action
<ul style="list-style-type: none"> <li>• Voids in characters</li> <li>• Light print</li> <li>• Prints off the page</li> <li>• Fuzzy print</li> <li>• Carrier moves but no print</li> <li>• Printhead dries prematurely</li> <li>• Colors print incorrectly</li> <li>• Vertical alignment off</li> </ul>	Go to the <b>“Print quality service check” on page 2-15.</b>
<ul style="list-style-type: none"> <li>• Ink smearing</li> <li>• Vertical streaks on paper</li> <li>• Print lines crowded</li> </ul>	Go to the <b>“Paper feed service check” on page 2-11.</b>

---

## Service checks

### Carrier transport service check

	FRU	Action
1	System Board  Carrier Transport Motor	Check the carrier transport motor connector CN3. If connected, check for approximately 30 volts on pins 1 and 3 or at the wire connections located on the rear of the carrier transport motor. If voltage is incorrect, replace the system board. If voltage is correct, check the motor for shorts. If a short is found, replace the motor. Go to <b>“Carrier transport motor removal” on page 4-24.</b>

	FRU	Action
2	Carrier Transport Motor	<p>Check the motor for binds, or loose motor pulley.</p> <p>A noisy or chattering motor, or a motor that fails to turn, can be caused by:</p> <ul style="list-style-type: none"> <li>• An open or short in the motor</li> <li>• An open or short in the motor driver on the system board</li> <li>• A bind in the carrier transport mechanism</li> </ul> <p>With the carrier transport motor cable (CN3) disconnected from the system board, check for 0 to 16 ohms between the following pins on the motor:</p> <p>CN3-2 and CN3-3</p> <p>If the readings are incorrect, replace the print engine. Go to the <b>“Print engine removal” on page 4-16.</b></p>
3	Carrier Guide Rod	<p>Clean the carrier rod.</p> <p><b>Note:</b> Lubricate the rod and the carrier rod bearing surfaces with grease P/N 99A0394.</p>
4	Encoder Strip Carrier Assembly with Belt	<p>Check the encoder strip for proper installation. Also, check it for wear, dirt, and grease. Replace if needed.</p> <p>Be sure all printhead connectors are fully seated. Check the cables for damage.</p> <p>If the encoder strip and all connections are okay, but the carrier still slams the side frame, replace the carrier assembly with belt. Go to the <b>“Carrier assembly with belt removal” on page 4-18.</b> If problem remains, replace the system board. Go to the <b>“System board removal” on page 4-19.</b></p>
5	Carrier Transport Belt Idler Pulley Assembly	<p>Check for worn, loose or broken parts. Check for obstructions blocking carrier movement. If pulley assembly is damaged, replace.</p> <p>Lubricate carrier to carrier frame engagement with grease P/N 99A0394.</p>

	FRU	Action
6	Maintenance Station	A problem with the maintenance station can cause carrier movement problems at the right margin. Go to the <b>“Maintenance station removal” on page 4-17.</b>
7	Access Door Sensor	If the carrier does not move toward the cartridge load position when the access door is opened, verify that power is on. If the carrier still does not move, replace the system board. Go to the <b>“System board removal” on page 4-19.</b>

## CIS assembly service check

The CIS lamp does not light when scanning is in process.

	FRU	Action
1	CIS Assembly	If light does not come on during the scanning process, check connector CN6 on the system board. If the connection is okay, replace the CIS assembly. Go to the <b>“CIS (Contact Image Sensor) removal” on page 4-10.</b> If problem still persists, replace the system board. Go to the <b>“System board removal” on page 4-19.</b>



## Scanner motor with gear assembly service check

Motor will not run.

	FRU	Action
1	Scanner Motor with Gear Assembly	<p>Check scanner motor for shorts. Disconnect connector CN1 from the system board and check for approximately 6 ohms between the following pins on the motor connector. CN1-1 and CN1-2</p> <p>If the ohms reading is incorrect, replace the scanner motor assembly. If the motor does not come on during the scanning process, check connector CN1 on the system board. If the connection is okay, check for voltage reading of approximately 30 volts at pins CN1-1 CN1-2 CN1-3 CN1-4</p> <p>If voltage is correct, replace the scanner motor with gear assembly. Go to the <b>“Scanner motor with gear assembly removal” on page 4-11</b>. If voltage is incorrect, replace the system board. Go to the <b>“System board removal” on page 4-19</b>.</p>
2	Document Scanner Sensor	<p>To check the document scanner sensor, insert a sheet of paper or press the sensor to see if the scanner motor is working. Go to <b>“Control panel problems” on page 2-3</b>.</p>

## Maintenance station service check

The maintenance station has three functions:

1. Wipes the printhead nozzles to clean them of dirt.
2. Provides a place for printheads to fire all nozzles, keeping them clear prior to printing.
3. Seals the printhead when it is not being used to prevent the nozzles from drying.

	FRU	Action
1	Maintenance Station Assembly	<p>As the carrier moves to the right over the maintenance station, a slot on the bottom of the carrier engages a tab on the sled of the maintenance station causing the cap to rise and seal the printhead. Carrier movement to the left uncaps the printhead. The wiper cleans the printhead nozzles as the carrier leaves the maintenance station. The wiper cleans the printhead only when the carrier is moving to the left. Do not wipe the printhead nozzles when the carrier is moving to the right. After the cleaning operation is complete, a tab on the maintenance station engages a tab on the carrier, causing the wiper to lower.</p> <p>Check the maintenance station for worn or broken parts. Replace if needed. Go to the <b>“Maintenance station removal” on page 4-17.</b></p> <p>Worn wipers cause degraded print quality just after a maintenance cleaning. Check for loose or worn wipers.</p> <p>Worn caps cause the printhead nozzles to dry and clog. Check for loose or worn caps.</p>

## Paper feed service check

If your machine does not have paper jam problems, continue with the service check. If your machine does have a paper jam, examine it for the following before you begin the service check:

- Check the entire paper path for obstructions.
- Be sure there is not too much paper in the sheet feeder.
- Be sure the correct type of paper is being used.
- Check for static in the paper.

	FRU	Action
1	System Board	Run the <b>“Power-On Self Test (POST) sequence” on page 2-1</b> . Replace parts as needed. To check the paper feed motor, disconnect the paper feed connector CN7 and check for approximately 4 ohms between pins 1 and 4. If the reading is incorrect, replace the paper feed motor assembly with gears. If the reading is correct, check connector CN7 pins 1,2,3,4 for approximately 30 volts. If the voltage is incorrect, replace the system board Go to the <b>“System board removal” on page 4-19</b> .

	FRU	Action
2	Paper Feed Motor	<p>A noisy or chattering motor or a motor that fails to turn, can be caused by:</p> <ul style="list-style-type: none"> <li>• An open or short in the motor</li> <li>• An open or short in the motor driver on the system board</li> <li>• A bind in the paper feed mechanism</li> </ul> <p>With the paper feed motor cable CN7 disconnected from the system board, check for approximately 4 ohms between the following pins on the motor:</p> <p>Pin 1 to Pin 4</p> <p>If the readings are incorrect, replace the paper feed motor assembly with gears. Go to the <b>“Paper feed motor assembly with gears removal” on page 4-23.</b></p> <p>Although the paper feeds in a forward direction only, the paper feed motor turns in two directions. If the paper feed motor turns in one direction only, replace the system board. Go to the <b>“System board removal” on page 4-19.</b></p> <p>Binds in the paper feed motor or gear train can cause intermittent false paper jam errors. Remove the paper feed motor and check the shaft for binds. Also check for a loose or worn motor gear.</p>
3	Auto Sheet Feeder Assembly	Check the pick roller for wear.
4	End-of-Forms Flag and Spring	Check for binds or damage.

## Paper path service check

Examine the machine for the following before you begin this service check:

- Check the entire paper path for obstructions.
- Be sure the correct type of paper is being used.
- Be sure the printer is installed on a flat surface.

	FRU	Action
1	Large and Small Feed Rollers	Check for wear and binds.
2	Small Feed Roller Springs	Check for damage or disconnected springs.
3	Auto Sheet Feeder Assembly	Check the pick roller for wear.
4	Mid Frame Asm	Check the following for wear: <ul style="list-style-type: none"> <li>• Exit roller</li> <li>• Star rollers</li> </ul>
5	End-of-Forms Flag	Check for binds or damage.
6	White Roller Assembly	Check for correct installation. Check gear and bushings for damage. If damaged, replace. Go to the <b>“CIS white roller assembly removal” on page 4-4.</b>

## Power service check

	FRU	Action
1	Power Supply	Plug the machine into an outlet. Check for approximately 30 V dc at CN4 pin 2. If voltage is incorrect, replace the power supply.
2	Printhead Cables Paper Feed Motor Carrier Transport Motor Control Panel	Unplug the printer. Disconnect the printhead cables and plug in the printer. Look for a symptom change. Check the failing part for shorts and replace as necessary.  Repeat this procedure for the carrier transport motor, paper feed motor, and control panel.
3	System Board	If the symptom has not changed, replace the system board. Go to the <b>"System board removal" on page 4-19.</b>

## Print quality service check

	FRU / Function	Action
1	Printhead Cartridge	Be sure the machine contains good print cartridges.
2	Color Printhead Cartridge Cross Contamination	<p>Cross contamination of color inks results in incorrect colors printed, as when green prints for yellow, (when yellow and blue are mixed in the printhead cartridge). This problem resolves quickly as the printhead cartridge is used.</p> <p>If cross contamination occurs, check the following:</p> <ul style="list-style-type: none"> <li>• The maintenance station wiper for damage.</li> <li>• The printhead nozzle plate was resealed with tape.</li> </ul>
3	Carrier Assembly	<p>Reseat the printhead cables in the system board and check the following parts for wear or damage:</p> <ul style="list-style-type: none"> <li>• Printhead Cartridge Latch</li> <li>• Latch Spring</li> <li>• Carrier</li> </ul>
4	System Board Carrier Assembly	<p>Print the self test page. To enter the self test page, press <b>Options</b> button until "Maintenance" is displayed. Then press the + button until "Test Page" is displayed. Press the <b>Select</b> button to print the test page. Look for a break in the diagonal line of the nozzle test pattern. A broken line indicates one or more print nozzles are not working. Run the test again to verify the failure.</p> <p>Check the gold-plated contacts on the end of the printhead carrier cable for dirt, wear, and damage. Use only a clean dry cloth to clean the contacts. If a problem is found with contacts on the carrier, replace the carrier. Go to the <b>"Carrier assembly with belt removal" on page 4-18.</b></p> <p>If the symptom remains, replace the system board. Go to the <b>"System board removal" on page 4-19.</b></p>
5	Maintenance Station	<p>Intermittent nozzle failures can be caused by worn parts in the maintenance station. Go to the <b>"Maintenance station removal" on page 4-17,</b> and then return to this check.</p>

	FRU / Function	Action
6	Paper Feed	<p>Ink smudging and smearing can be caused by paper problems or problems in the paper feed area.</p> <p>Check the following:</p> <ul style="list-style-type: none"> <li>• Correct type of paper is being used. Also check the paper for curl or wrinkles.</li> <li>• Feed rollers for wear, dirt, or looseness.</li> <li>• Gears for wear or binds.</li> <li>• Paper path for obstructions.</li> </ul>
7	Carrier Transport	<p>Blurred print and voids can be caused by problems in the carrier transport area. Check the following:</p> <ul style="list-style-type: none"> <li>• Carrier transport belt for wear.</li> <li>• Carrier guide rod for wear or dirt. If dirty, clean and lubricate.</li> <li>• Carrier to carrier frame engagement should be lubricated with grease P/N 99A0394.</li> <li>• Idler pulley parts for wear, damage, or looseness.</li> </ul>
8	Alignment	<p>Uneven vertical lines can be adjusted by performing the printhead alignment adjustments in the maintenance mode. The user is directed, to perform the printhead alignment adjustments, when replacing a printhead cartridge.</p>



## Scan/copy quality service check

	FRU / Function	Action
1	Scanned images are faded, or colors are dull, blurry, or fuzzy. Images are slanted or crooked and the straight lines in the image appear to be jagged or uneven.	<p>Check the lighter/darker settings to see if it is correct.</p> <ul style="list-style-type: none"> <li>• From the control panel</li> <li>• From the Scan &amp; Copy Control Program</li> </ul> <p>Check to see if there is any dust or debris on the glass lens of the CIS. This may cause a poor image.</p>
2	Blank copies	<p>If there are blank copies found, make sure that the original document is facing down.</p> <p>Check the print cartridges to see if they need to be cleaned or replaced.</p>
3	Scanning error	<p>Ensure the USB cable is correctly installed.</p> <p>Ensure the USB cable is proper for USB specification, version 1.1.</p> <p>Start the system after TWAIN driver is reinstalled.</p> <p>If error still occurs, replace the system board. Go to the <b>“System board removal” on page 4-19.</b></p>

## Fax/telephone communication service check

	FRU / Function	Action
1	System Board  Cannot make telephone connection to other fax.	<p>No dial tone</p> <p>Verify correct dialing method (tone or pulse). Are TEL and LINE connections reversed? Verify phone number and availability of other fax machine.</p> <p>You should hear the ring and a 0.5 second 1000 Hz calling tone from your machine, a one second pause, then the three second 2100 Hz fax response tone and a 1650 Hz - 1850 Hz "warbling" handshaking tone from the called machine.</p> <p>Check connector CN12 on the system board located behind the fire shield. If problem still exists, replace the system board. Go to the <b>"System board removal"</b> on page 4-19.</p>
2	Cannot receive faxes	<p>Are TEL and LINE connections reversed? Is a telephone on the same line off the hook? Is the machine connected to the wrong telephone line?</p> <p>Check for a damaged line cord to the machine. Check telephone and line cord connections.</p>

---

## 3. Diagnostic aids

---

### Theory of mechanism

#### Scanner mechanism

The scanner mechanism consists of components which feed, scan, and eject the documents that are to be copied or transmitted to a remote facsimile unit. These components and their functions are explained below.

#### Drive feed roller assembly

The drive feed roller assembly, consisting of various rollers, rubber pad, and springs, automatically separates and feeds the pages of a document over the scanning area and stacks them on the document exit tray.

Documents up to 15 pages can be placed in the drive feed roller assembly for scanning. The leading edge of the document moves the document detect sensor lever when the operator slides the stack into the drive feed roller assembly. The scan motor starts to rotate when the document detect sensor detects the leading edge of the document. The roller feeds the first page of the document into the feeder.

The scan motor stops when the leading edge of the page actuates the document scan sensor. The page is now in the scan position.

The drive feed roller assembly rubber pad prevents multiple sheets from being fed. A spring provides force that the pad places on the document pages for proper separation.

The scan motor is turned on when the machine is ready to scan the document and drives the feed roller at a speed determined by the resolution selected. The scan motor stops after a set period of time when the trailing edge of the page releases the document scan sensor. If another page is detected as the trailing edge of the page releases the document scan sensor, the next page feeds to the scan position. The exit roller pushes the page out onto the document exit tray where it is stacked.

## Contact Image Sensor (CIS)

The contact image sensor unit consist of LEDs, rod lens array, and a photo sensor. The LEDs illuminate the document to be scanned when the leading edge is detected by the document scan sensor. The LEDs turn off when the document exits the scanner mechanism.

The LEDs illuminate the document to obtain an image from the document through the rod lens array, where the image is translated into voltage levels.

## Document sensors

There are two document sensors in the scanner mechanism; the document detect and the document scan sensor. The document detect sensor, detects whether or not a document is loaded, and the document scan sensor detects the scan position of the document. The scanner mechanism consists of components which feed, scan, and eject the documents that are to be copied or transmitted to a remote facsimile unit.

**Set up options**

<b>Setup</b>	<b>Item</b>	<b>Default</b>
Print Report	Send Log Receive Log Setting List Activity Report	
Number of Rings	After 3 Rings After 5 Rings After 2 Rings	After 3 Rings
Delay Until	Do not Delay Set Delay	Do not Delay
On Hook Dial	Enter Fax Number	
Ringer Tone	Low/High/Off	Low Ring Tone
Key Press Tone	On/Off	On
Speaker Volume	High/Off/Low	Low
Edit Speed Dial	Add/Remove/Modify/ Print	
Edit Date Time	Date/Time	
Personalized Fax	Name/Number	
Blank Paper Size	Legal/Letter/A4	Letter
Blank Paper Type	Plain/Coated/Photo/ Transparency	Plain
Fax Forward	Off/Forward/Forward and Print	Off
Advanced Fax	Press Select/Redial attempts 1,2,3,4,5,0 times	2
Maintenance	Ink Levels Change/ Align/Clean/Test Page	
Power Save	After 15 Minutes After 30 Minutes After 60 Minutes Never	After 30 Minutes

**4413-XXX**

<b>Setup</b>	<b>Item</b>	<b>Default</b>
Clear Settings	After 2 Minutes Never	After 2 Minutes
Set Defaults	Use Current Use Factory	

---

## 4. Repair information

This chapter explains how to make adjustments to the printer and how to remove defective parts.

**Note:** Read the following before handling electronic parts.

---

### Handling ESD-sensitive parts

Many electronic products use parts that are known to be sensitive to electrostatic discharge (ESD). To prevent damage to ESD-sensitive parts, follow the instructions below in addition to all the usual precautions, such as turning off power before removing logic boards:

- Keep the ESD-sensitive part in its original shipping container (a special “ESD bag”) until you are ready to install the part into the machine.
- Make the least-possible movements with your body to prevent an increase of static electricity from clothing fibers, carpets, and furniture.
- Put the ESD wrist strap on your wrist. Connect the wrist band to the system ground point. This discharges any static electricity in your body to the machine.
- Hold the ESD-sensitive part by its edge; do not touch its pins. If you are removing a pluggable module, use the correct tool.
- Do not place the ESD-sensitive part on the machine cover or on a metal table; if you need to put down the ESD-sensitive part for any reason, first put it into its special bag.
- Machine covers and metal tables are electrical grounds. They increase the risk of damage because they make a discharge path from your body through the ESD-sensitive part. (Large metal objects can be discharge paths without being grounded.)
- Prevent ESD-sensitive parts from being accidentally touched by other personnel. Install machine covers when you are not working on the machine, and do not put unprotected ESD-sensitive parts on a table.
- If possible, keep all ESD-sensitive parts in a grounded metal cabinet (case).
- Be extra careful in working with ESD-sensitive parts when cold weather heating is used because low humidity increases static electricity.

---

## Adjustments

The user is directed, in the Printer Control program, to perform the bidirectional alignment adjustments after replacing a print cartridge.

---

## Removal procedures

The following procedures are arranged according to the name of the printer part discussed.

**CAUTION: Unplug the power cord before removing any parts.**

### Releasing plastic latches

Many of the parts are held in place with plastic latches. The latches break easily; release them carefully. To remove such parts, press the hook end of the latch away from the part to which it is latched.

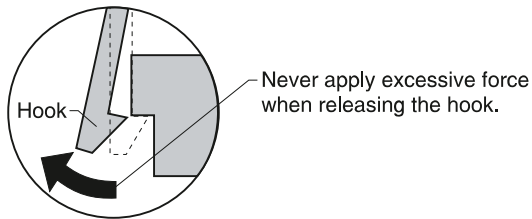



---

## Removals

### General precautions on removals

When you disassemble and reassemble components, use extreme caution. The close proximity of cables to moving parts makes proper routing a must. If components are removed or replaced, any cables disturbed must be replaced as close as possible to their original positions. Before removing any component from the machine, note the cable routing.

When servicing the machine:

- Check to verify that documents are not stored in memory.
- Move the printer cartridge to far right to cap the nozzle.
- Unplug the power cord.
- Use a flat and clean surface.
- Replace only with authorized components.
- Do not force plastic-material components.
- Make sure all components are in their proper position.

## CIS white roller assembly removal

1. Open the control panel.
2. Press the release arm (A) on the right end of the roller slightly inward, and then rotate it until it reaches the slot. Lift the roller out.

**Note:** If the roller is dirty, wipe it with a soft cloth dampened with water. If the roller is heavily worn, replace it.

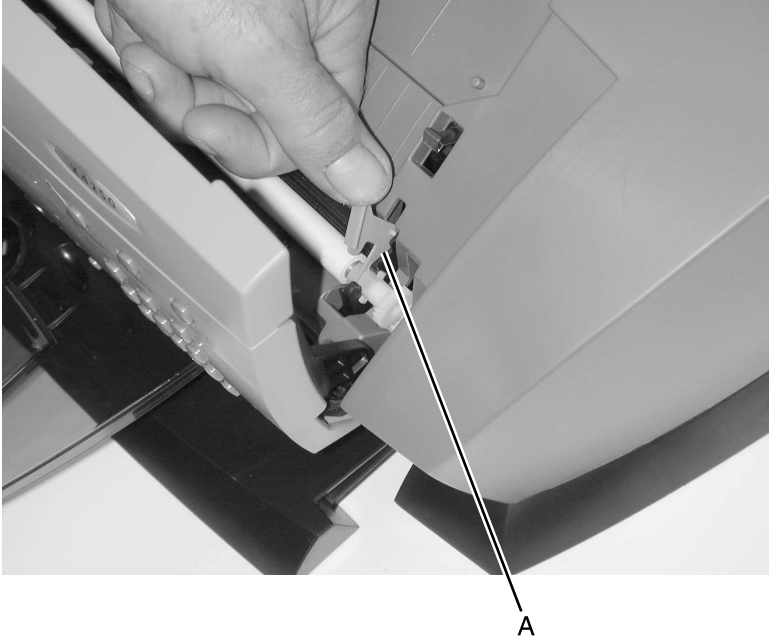

## Top cover assembly removal

1. Open the control panel and open the print cartridge compartment cover. Remove the white roller assembly.
2. Remove paper support.
3. Remove the eight screws (A).

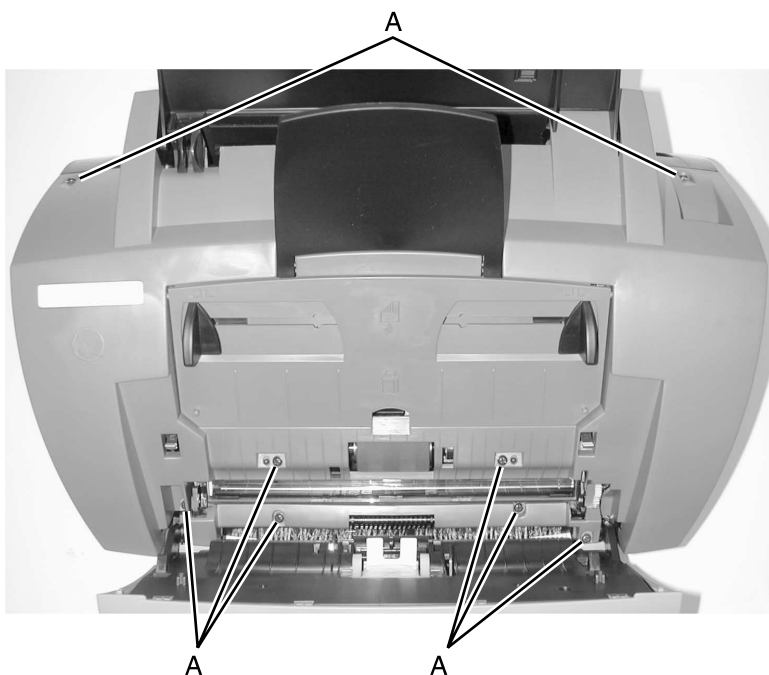

4. Remove the top cover.

## Rollers (drive feed roller assembly, exit shaft) removal

1. Remove the top cover assembly. See **“Top cover assembly removal”** on page 4-5.
2. Remove paper support.
3. Disconnect the CIS cable (A) from the system board.

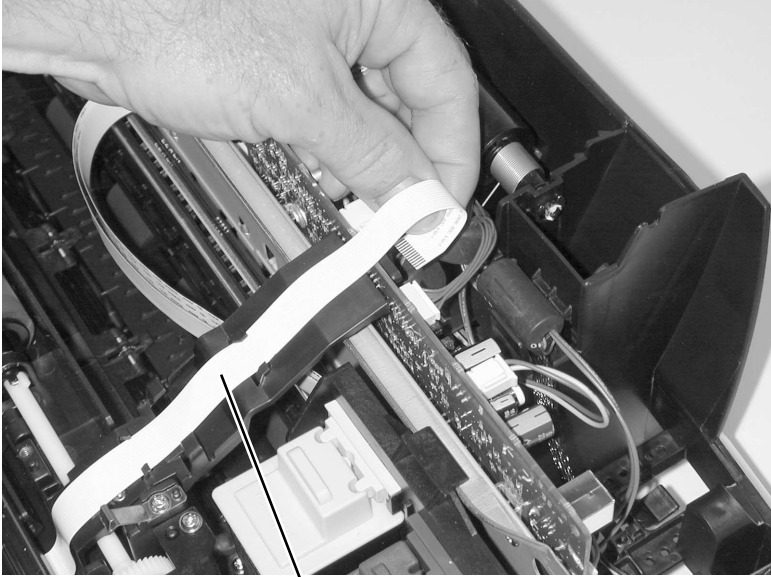

A

## 4413-XXX

4. Remove the screw (B) from the cable support and remove cable support.

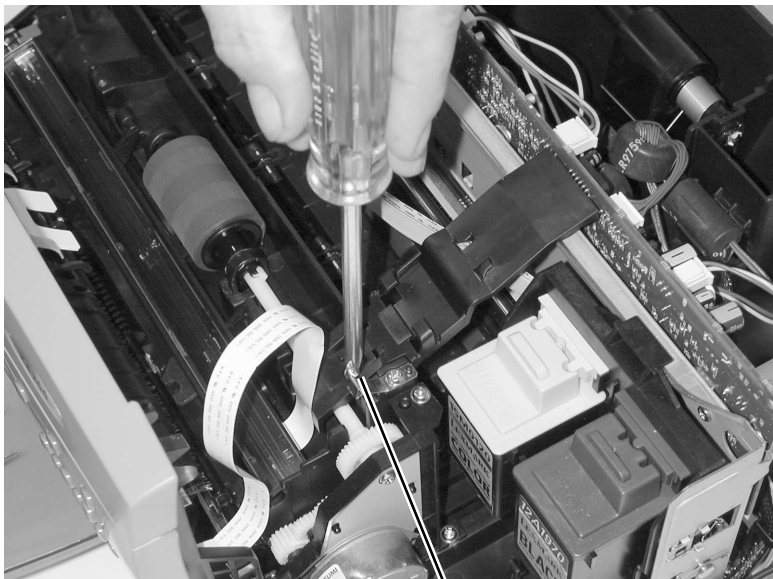

B

5. Remove three screws (C) from the scanner motor with gear assembly.

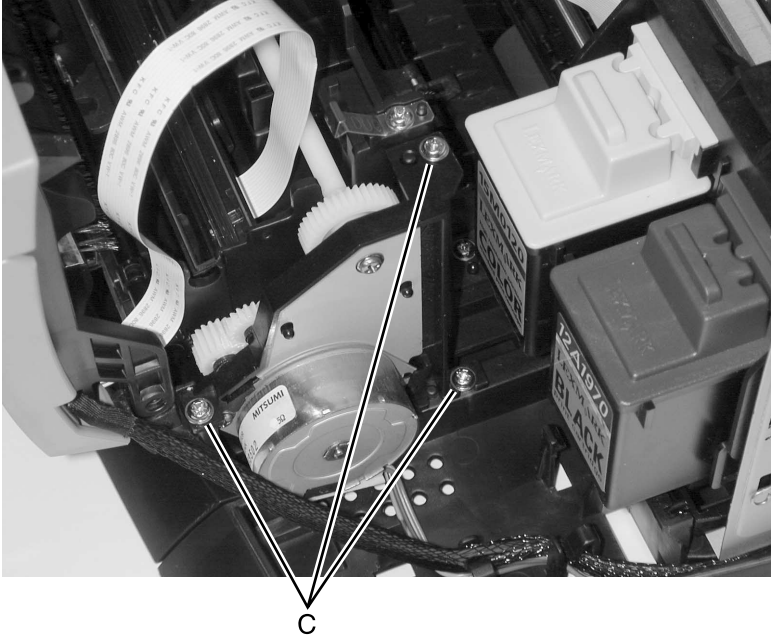

6. Slide and remove drive feed roller assembly (D).

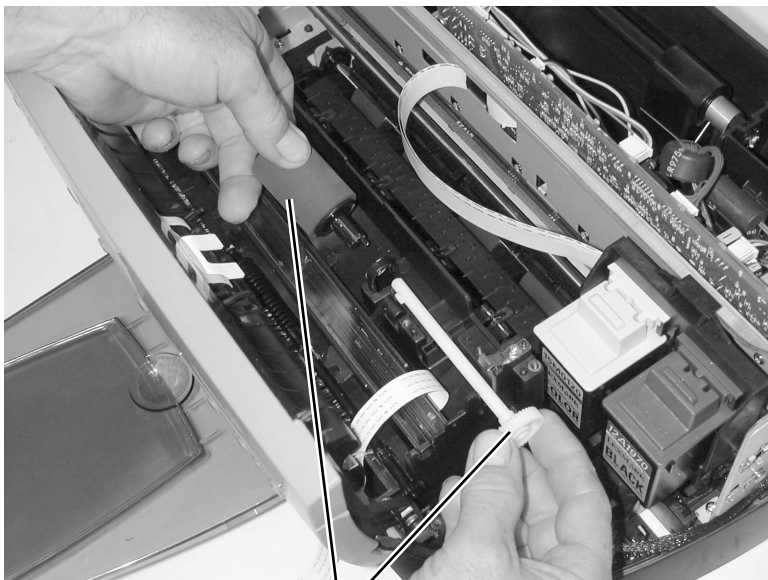

D

**Note:** Clean the surface of the rollers with ethyl alcohol. After wiping them, you must dry them completely.

**Note:** Routing of all cables.

## CIS (Contact Image Sensor) removal

1. Remove the top cover assembly. See **“Top cover assembly removal”** on page 4-5.
2. Disconnect the CIS cable from the system board.
3. Depress hinge (A) and lift to remove.

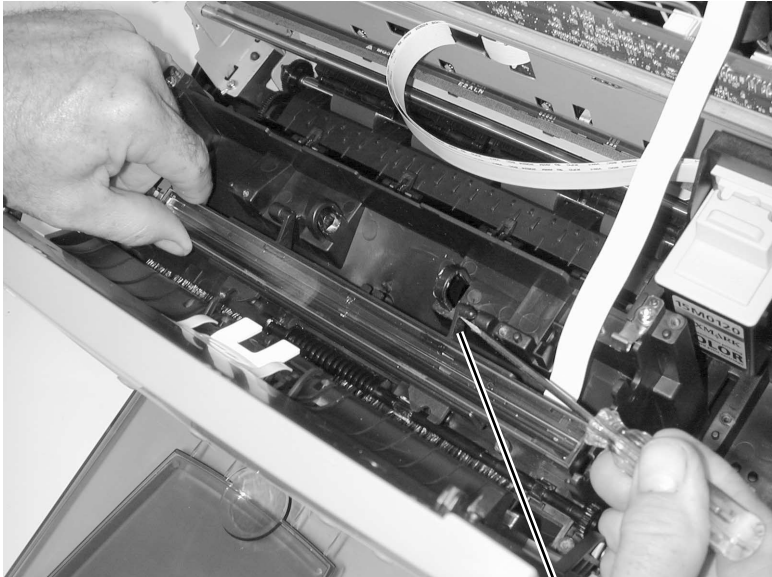

A

4. Remove CIS assembly.

**Note:** Check the glassy surface of the CIS for any stain or scratch. If stained, wipe off with ethyl alcohol. If it is heavily stained or scratched, replace it.



## Scanner motor with gear assembly removal

1. Remove the top cover assembly. See **“Top cover assembly removal” on page 4-5.**
2. Disconnect scanner motor cable (A) from the system board.

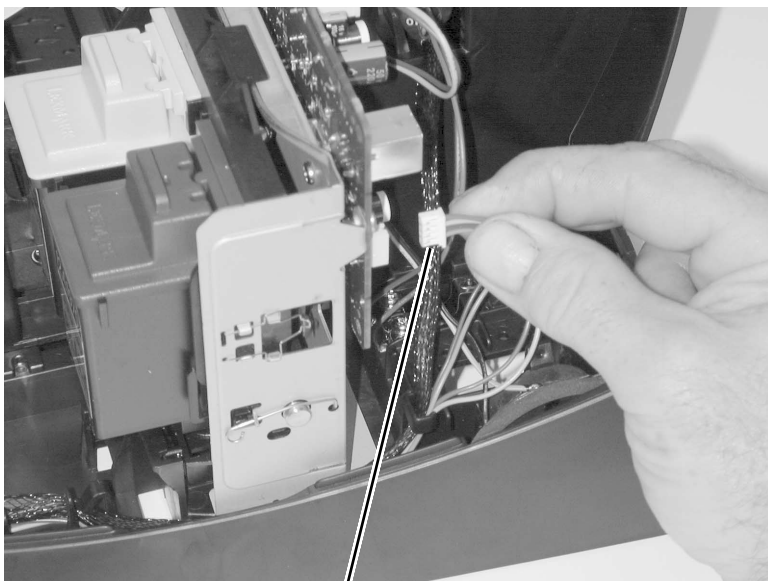

A

3. Remove three screws (B) as shown and remove the scan motor assembly.

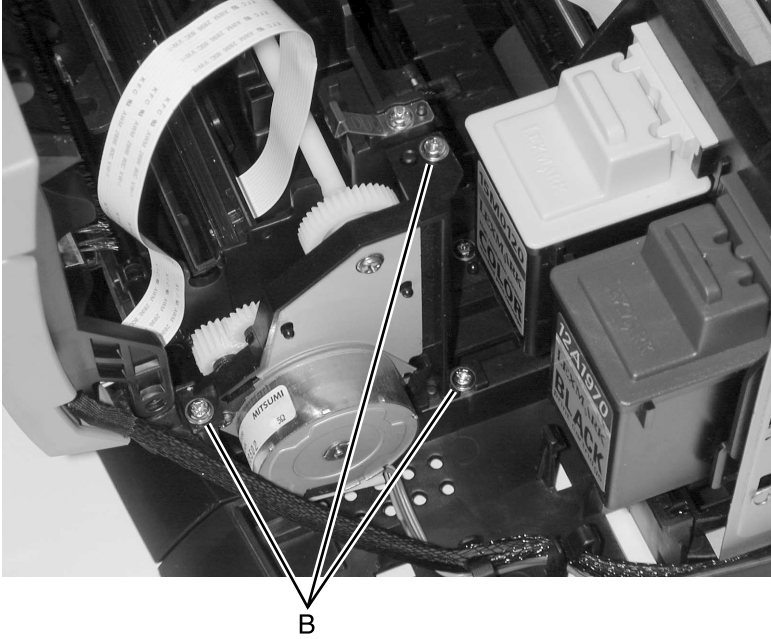

## Control panel assembly removal

1. Remove the top cover assembly. See **“Top cover assembly removal”** on page 4-5.
2. Disconnect the control panel cable (A) from the system board.

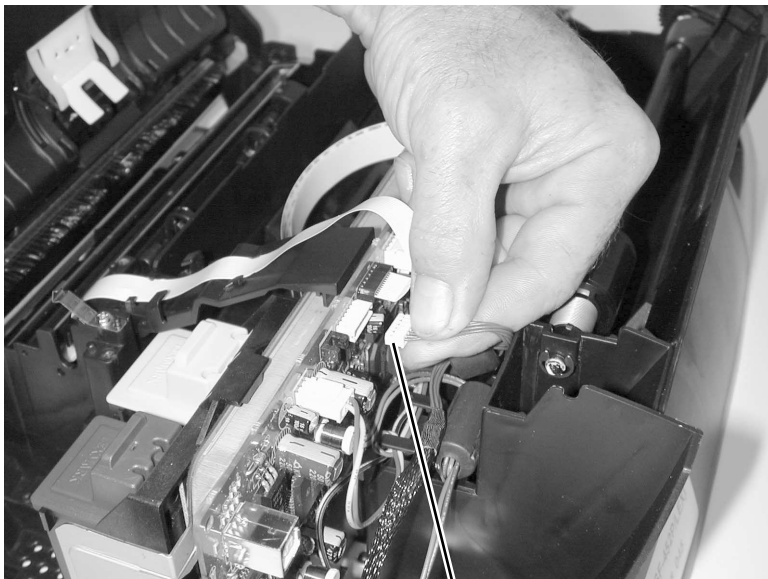

A

3. Release harness from harness hook.

**4413-XXX**

4. Remove the two ground strap screws (B) from the left side of the printer.

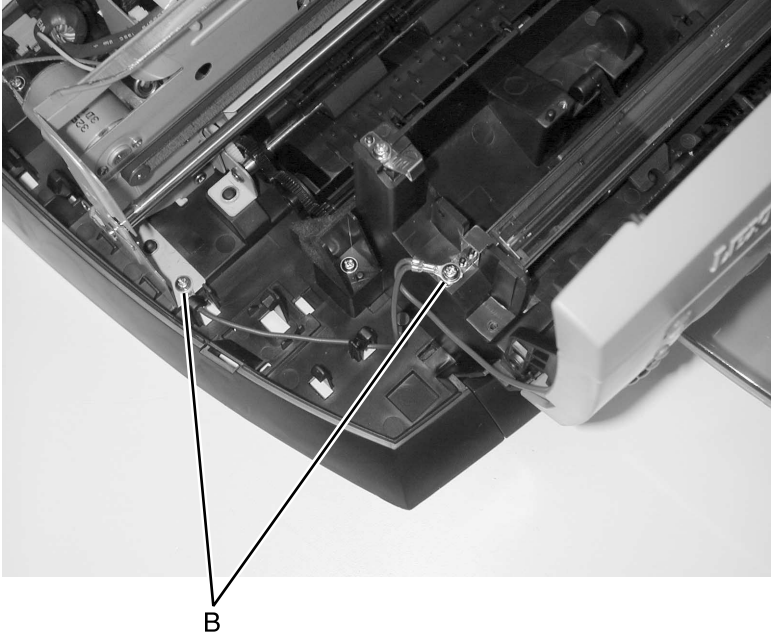

4413-XXX

5. Depress hinge (C) and remove control panel assembly.

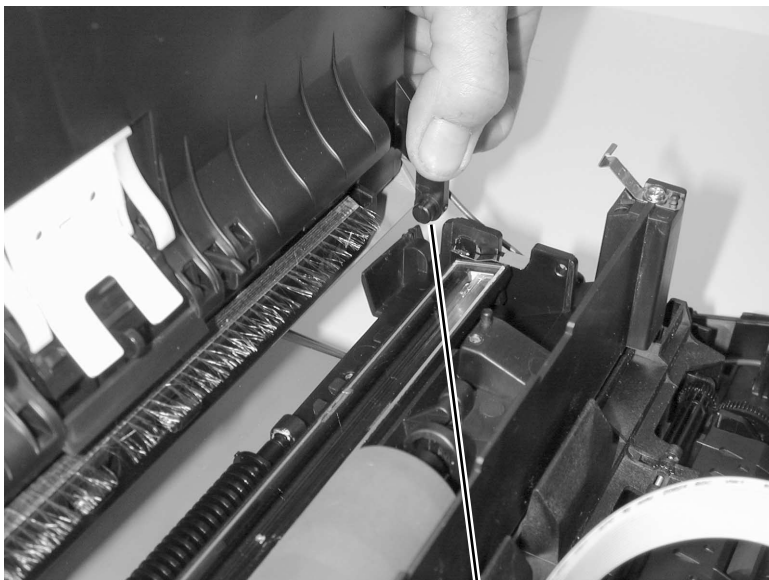

C

## Print engine removal

1. Remove the top cover assembly. See **“Top cover assembly removal”** on page 4-5.
2. Remove the paper support.
3. Disconnect the CIS cable from system board.
4. Remove CIS cable support.
5. Disconnect all cables from the system board except for carrier ribbon cables.
6. Move carrier to center.
7. Remove five screws (A) from the print engine.

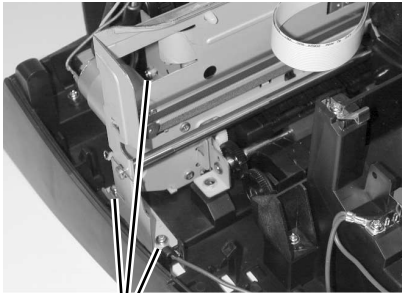

A

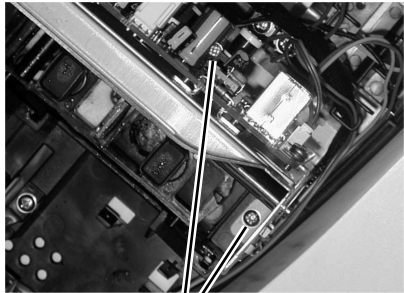

A

8. Lift and remove print engine.

**Note:** When reassembling the print engine, be sure not to pinch or short the wiring harness.

## Maintenance station removal

1. Remove the printer unit.
2. Move the maintenance station to the left and up.
3. Disconnect spring and remove maintenance station (A).

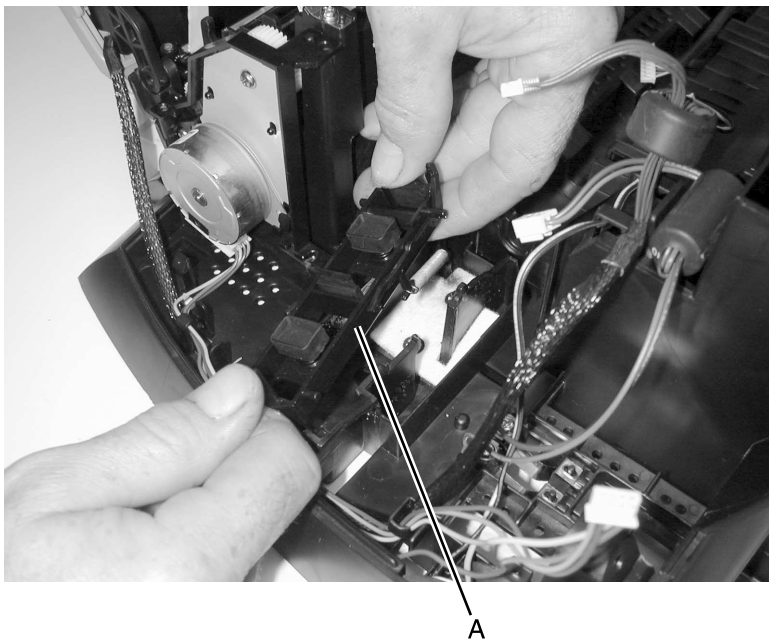

## Carrier assembly with belt removal

1. Remove the top cover assembly. See **“Top cover assembly removal”** on page 4-5.
2. Remove print engine. See **“Print engine removal”** on page 4-16.
3. Depress the belt tensioner (A) until tension is released.
4. Remove the belt (B) from the carrier motor.
5. Remove two carrier shaft retainer springs (C) that secure the shaft.

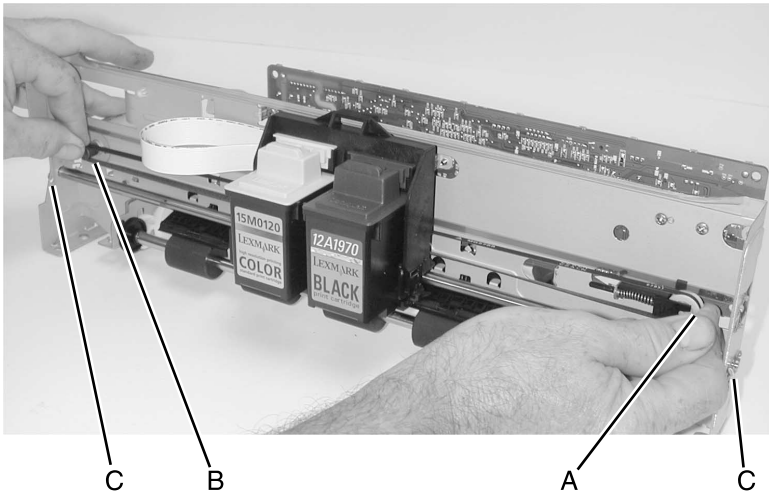

6. Disconnect carrier cables from the system board.
7. Remove the carrier shaft.
8. Remove the carrier assembly.

**Note:** Position of encoder strip.



## System board removal

1. Remove the top cover assembly. See **“Top cover assembly removal” on page 4-5.**
2. Unplug all connectors.
3. Remove four screws (A) securing the system board.
4. Remove the fire shield and disconnect connector CN12.

**Note:** Routing of cables.

5. Pull the EOF flag (B) toward you and remove the system board.

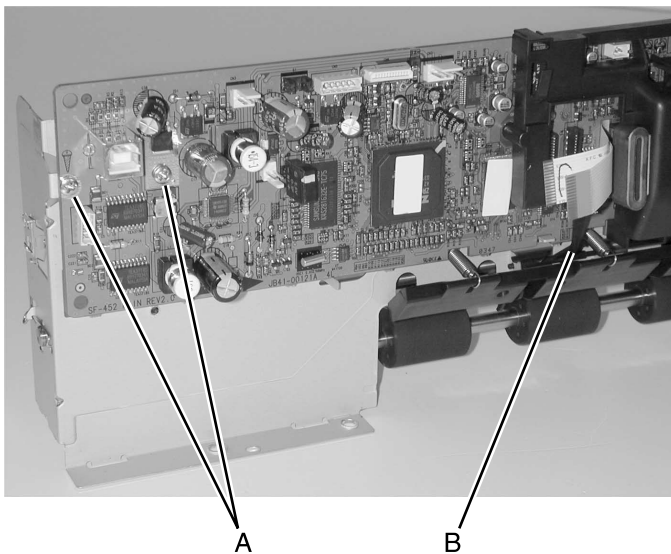

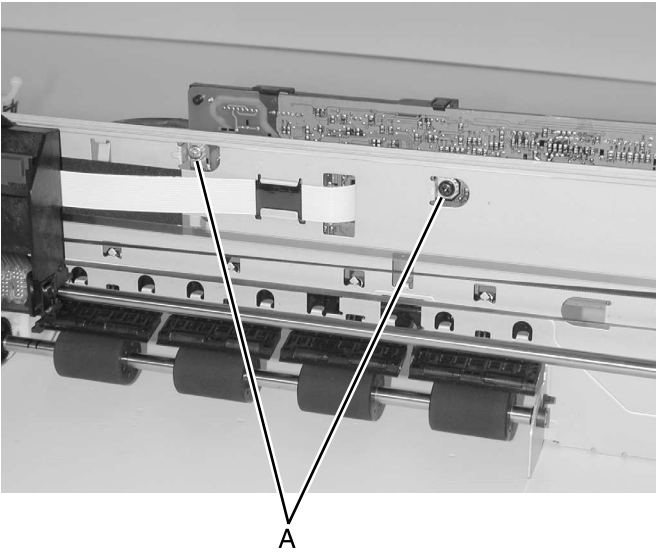

## Exit rollers removal

1. Remove the top cover. See **“Top cover assembly removal”** on page 4-5.
2. Remove print engine. See **“Print engine removal”** on page 4-16.
3. Remove two screws (A) from exit roller assembly.

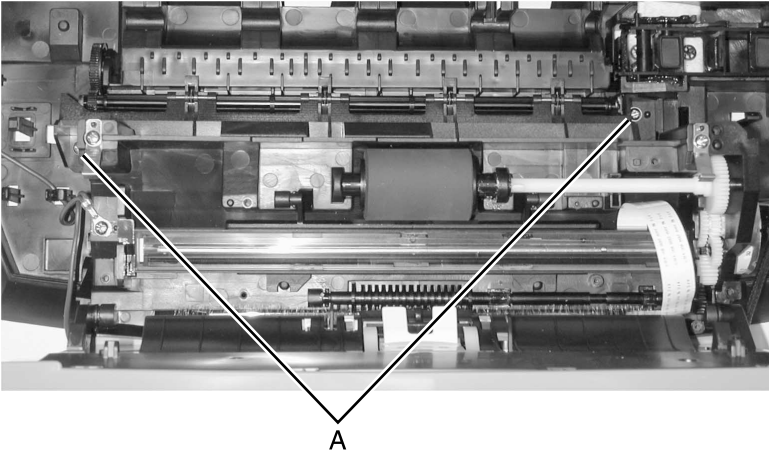

4. Remove exit roller assembly.

## Large feed roller assembly with gear removal

1. Remove the top cover. See **“Top cover assembly removal” on page 4-5.**
2. Remove the print engine. See **“Print engine removal” on page 4-16.**
3. Remove system board. See **“System board removal” on page 4-19.**
4. Disconnect four springs (A) from the pressure feed roller assembly and remove.

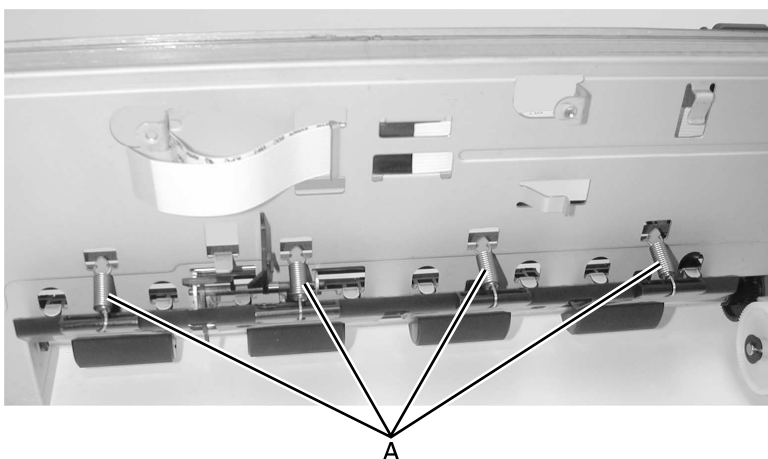

**4413-XXX**

5. Remove the feed roller bearing (B) from the main frame. Pull the feed roller and remove. Be careful not to damage the bearing.

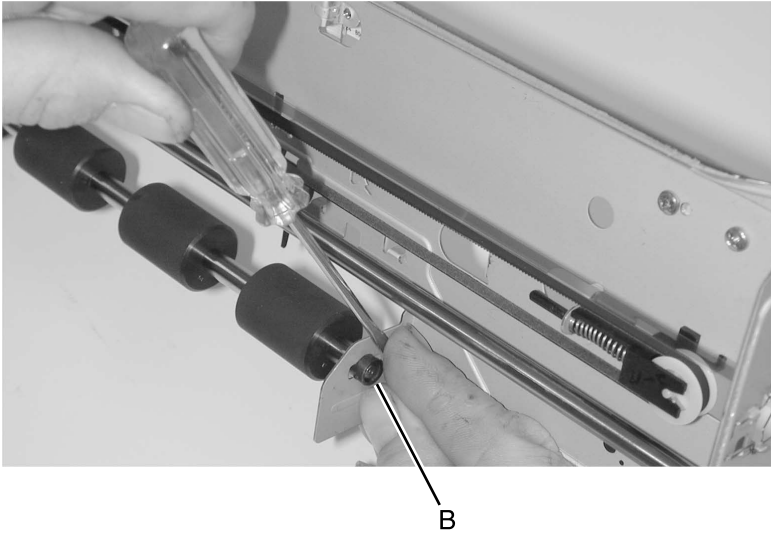

## Paper feed motor assembly with gears removal

1. Remove the top cover. See **“Top cover assembly removal” on page 4-5.**
2. Remove the print engine. See **“Print engine removal” on page 4-16.**
3. Remove carrier shaft.
4. Unplug paper feed motor from system board.
5. Remove large feed roller.
6. Remove the two screws (A) and remove the paper feed motor assembly.

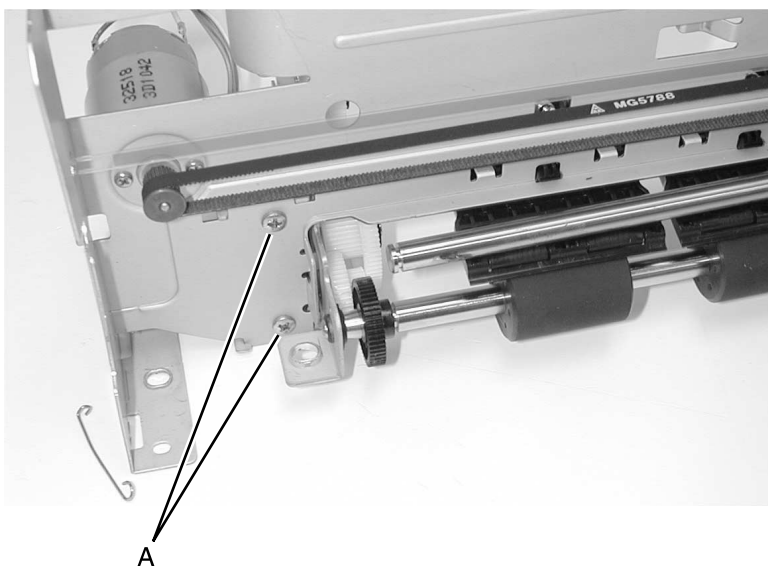

## Carrier transport motor removal

1. Remove the top cover assembly. Go to the **“Top cover assembly removal”** on page 4-5.
2. Remove the print engine. See **“Print engine removal”** on page 4-16.
3. Manually move the carrier to the center of the machine.
4. Press the idler pulley and remove the belt from the carrier transport pulley.
5. Disconnect carrier transport motor from the system board.
6. Remove the two screws (A) from the carrier transport motor and remove.

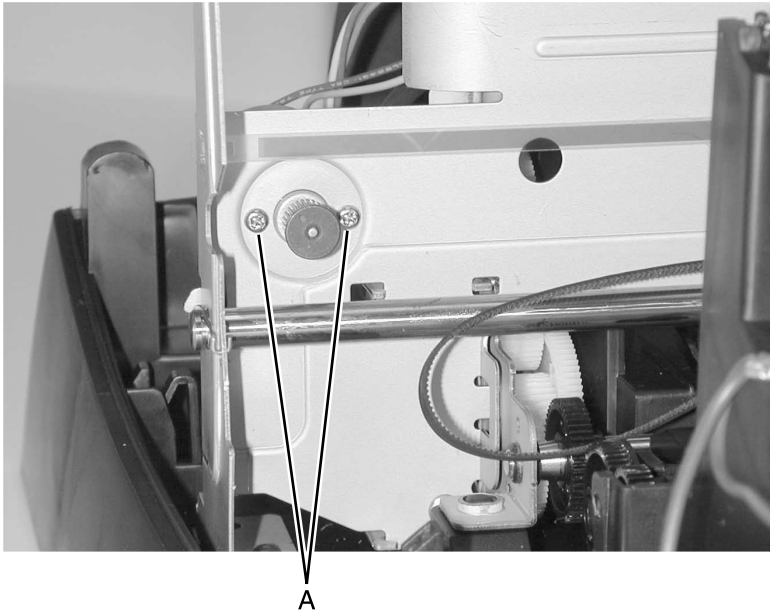

## Handset and cradle removal

1. Lift machine.
2. Remove one screw located under the handset on the base.
3. Unplug handset cable.
4. Depress the two clips located on the handset cradle and remove.

## 5. Connector locations

### System board

Units	Description
CN1	Scanner Motor with Gear Assembly
CN2	USB
CN3	Carrier Transport Motor
CN4	Power Supply
CN5	Control Panel
CN6	CIS
CN7	Paper Feed Motor
CN8	Carrier
CN9	Carrier
CN10	Speaker
CN11	Handset and Cradle - K03,AK3
CN12	Phone Receptacles - K01,AK1,K03,AK3
S1	Access Door Sensor
S2	EOF

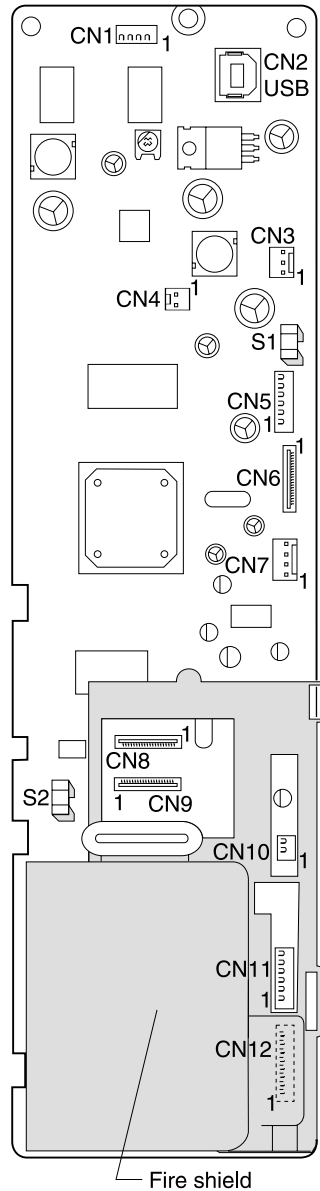

**4413-XXX**



---

## 6. Preventive maintenance

This chapter contains the lubrication specifications. Follow these recommendations to prevent problems and maintain optimum performance.

---

### Lubrication specifications

Lubricate only when parts are replaced or as needed, not on a scheduled basis. Use grease P/N 99A0394 to lubricate the following:

- All gear mounting studs.
- The left and right ends of the large feed roller at the side frames.
- The carrier to carrier frame engagement.
- The carrier guide rod and carrier guide rod bearings.

**4413-XXX**

---

## 7. Parts catalog

---

### How to use this parts catalog

---

- **SIMILAR ASSEMBLIES:** If two assemblies contain a majority of identical parts, they are shown on the same list. Common parts are shown by one index number. Parts peculiar to one or the other of the assemblies are listed separately and identified by description.
- **NS: (Not Shown)** in the Asm-Index column indicates that the part is procurable but is not pictured in the illustration.

# Assembly 1: Main assembly

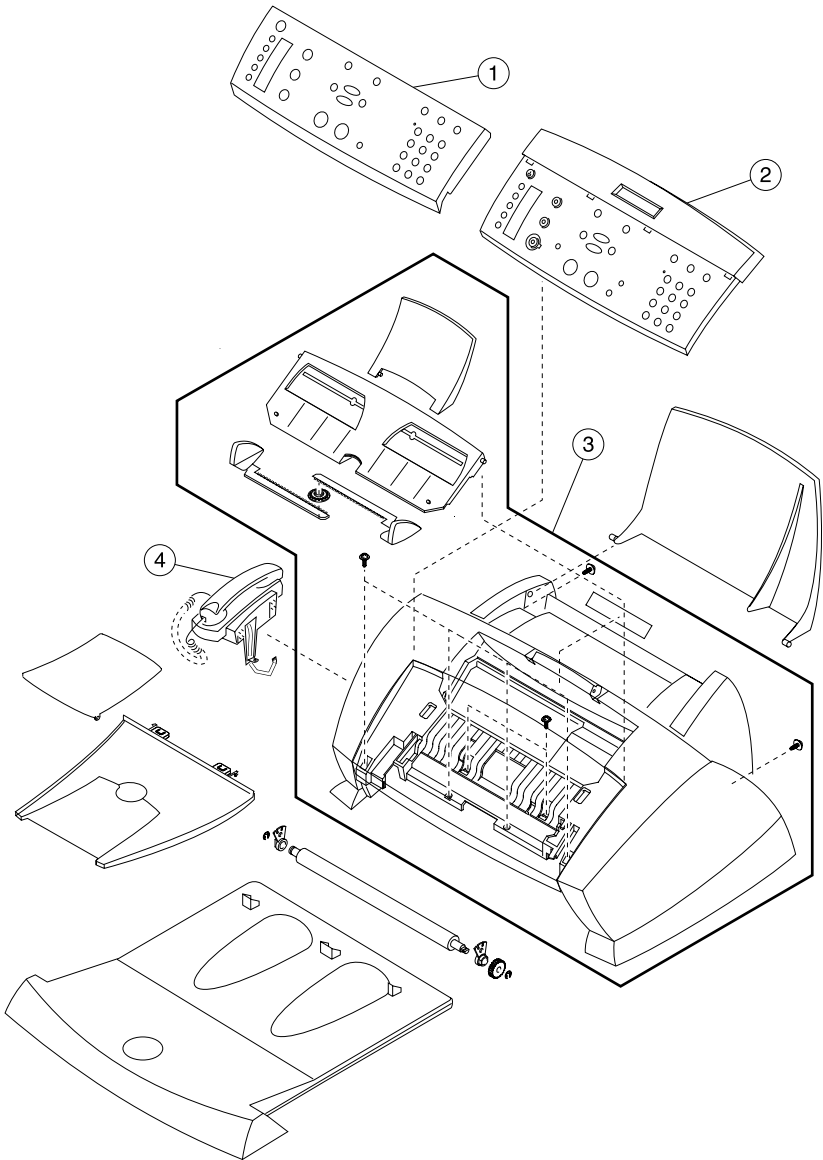

**Assembly 1: Main assembly**

<b>Asm-Index</b>	<b>Part Number</b>	<b>Units</b>	<b>Description</b>
1-1	56P2521	1	Control cover K01,AK1,K03,AK3 English, EMEA/APG
1	56P2522	1	Control cover K01,AK1,K03,AK3 Spanish
1	56P2523	1	Control cover K01,AK1,K03,AK3 French
1	56P2524	1	Control cover K01,AK1,K03,AK3 Brazil/Portuguese
1	56P2525	1	Control cover K01,AK1,K03,AK3 German
1	56P2526	1	Control cover K01,AK1,K03,AK3 Dutch
1	56P2527	1	Control cover K01,AK1,K03,AK3 Italian
1	56P2529	1	Control cover K01,AK1,K03,AK3 Russian
1	56P2530	1	Control cover K01,AK1,K03,AK3 Polish
1	56P2531	1	Control cover K01,AK1,K03,AK3 S/Chinese
1	56P2532	1	Control cover K01,AK1,K03,AK3 T/Chinese
1	56P2533	1	Control cover K01,AK1,K03,AK3 Japanese
1	56P2534	1	Control cover K01,AK1,K03,AK3 Greek
2	56P2449	1	Panel, control assembly K01,K03
2	56P2450	1	Panel, control assembly AK1,AK3
3	56P2445	1	Cover, top assembly K01,AK1,K03,AK3
4	56P2520	1	Phone handset/cradle K03,AK3

## Assembly 2: Base unit

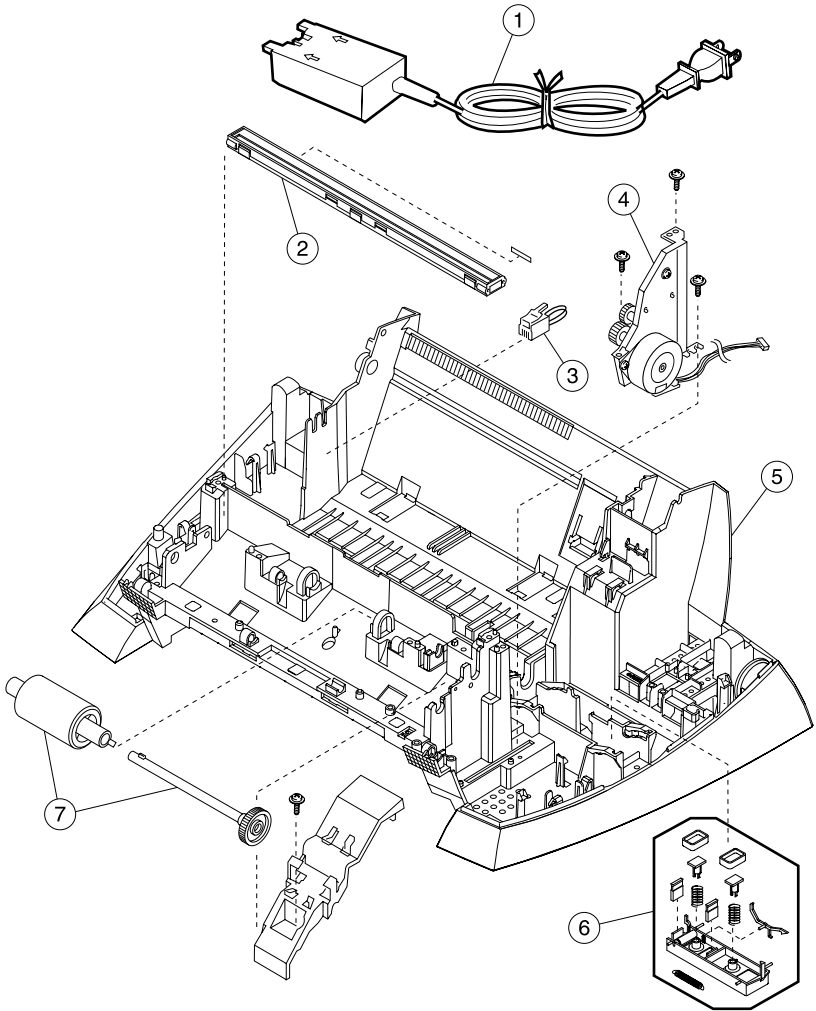

**Assembly 2: Base unit**

<b>Asm-Index</b>	<b>Part Number</b>	<b>Units</b>	<b>Description</b>
2-1	13D0400	1	Power supply 120V K01,AK1,K03,AK3
1	13D0401	1	Power supply 220V K01,AK1,K03,AK3
1	13D0402	1	Power supply 100V 50/60 Hz K01,AK1,K03,AK3
1	13D0403	1	Power supply 100V K01,AK1,K03,AK3
2	56P2452	1	Contact, image sensor (CIS) K01,AK1,K03,AK3
3	56P2455	1	Phone adapter K01,AK1,K03,AK3
4	56P2453	1	Motor, scanner with gear assembly K01,AK1,K03,AK3
5	56P2451	1	Base assembly K01,AK1,K03,AK3
6	56P2443	1	Maintenance station assembly K01,AK1,K03,AK3
7	56P2442	1	Drive feed roller assembly K01,AK1,K03,AK3
NS	11B6074	1	Power line cord K01,K03 (USA)
NS	56P1040	1	Power line cord K01,K03 (Brazil)
NS	11B6078	1	Power line cord K01,K03 (Peru)
NS	11B6073	1	Power line cord AK1,AK3 (Hong Kong)
NS	11B6076	1	Power line cord K01,K03 (Australia)
NS	14D0632	1	Power line cord AK1,AK3 (PRC)
NS	14D0630	1	Power line cord K01/K03 (South Africa)

# Assembly 3: Engine

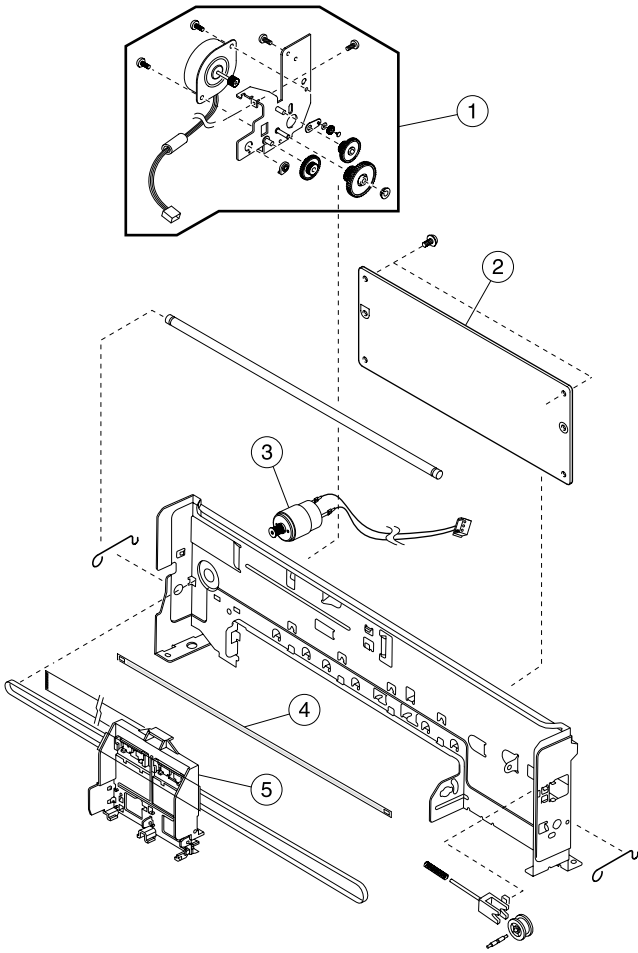



**Assembly 3: Engine**

<b>Asm-Index</b>	<b>Part Number</b>	<b>Units</b>	<b>Description</b>
3-1	56P2444	1	Motor, paper feed assembly with gears K01,AK1,K03,AK3
2	56P2447	1	System board K01,AK1
2	56P2448	1	System board K03,AK3
3	56P1168	1	Motor, carrier transport K01,AK1,K03,AK3
4	12G6968	1	Strip, encoder K01,AK1,K03,AK3
5	56P2454	1	Carrier assembly with belt K01,AK1,K03,AK3

**4413-XXX**

# Index

## A

abbreviations 1-5  
 adjustments 4-2  
 alignment 2-16

## B

base unit 7-4

## C

carrier transport 2-16  
 CIS assembly 2-8  
 connector locations 5-1  
 contact image sensor 3-2  
 control panel 2-3

## D

diagnostic aids 3-1  
 diagnostic information 2-1  
 document sensors 3-2  
 drive feed roller assembly 3-1

## E

engine 7-6  
 ESD-sensitive parts 4-1

## F

fax communication 2-18

## L

lubrication specifications 6-1

## M

main assembly 7-2  
 maintenance station 2-3

## P

paper feed 2-11, 2-16  
 paper path 2-13  
 parts catalog 7-1  
 plastic latches 4-2

POST 2-1

POST symptom table 2-2  
 power supply 2-14  
 preventive maintenance 6-1  
 print quality 2-6

## R

removal procedures 4-2  
 removals  
   carrier assembly 4-18  
   carrier transport motor 4-24  
   CIS white roller assembly 4-4  
   contact image sensor 4-10  
   control panel 4-13  
   exit rollers 4-20  
   large feed roller 4-21  
   maintenance station 4-17  
   paper feed motor 4-23  
   print engine 4-16  
   rollers 4-6  
   scanner motor 4-11  
   system board 4-19  
   top cover assembly 4-4, 4-5  
 repair information 4-1

## S

safety information v  
 scanner 2-5  
 scanner mechanism 3-1  
 scanner motor 2-9  
 service checks 2-6  
   carrier transport 2-6  
   CIS assembly 2-8  
   fax communication 2-18  
   maintenance station 2-10  
   paper feed 2-11  
   paper path 2-13  
   power 2-14  
   print quality 2-15  
   scan/copy quality 2-17  
   scanner motor 2-9  
   telephone communication 2-18  
 set up options 3-3

## 4413-XXX

specifications	1-2	56P2444	7-7
facsimile	1-3	56P2445	7-3
power and size	1-4	56P2447	7-7
print engine	1-2	56P2448	7-7
printhead	1-2	56P2449	7-3
scanner	1-4	56P2450	7-3
symptom tables	2-3	56P2451	7-5
carrier transport problems	2-3	56P2452	7-5
control panel problems	2-3	56P2453	7-5
maintenance station problems	2-3	56P2454	7-7
paper feed problems	2-5	56P2455	7-5
phone handset/cradle problem	2-4	56P2520	7-3
POST	2-2	56P2521	7-3
power problems	2-6	56P2522	7-3
print quality problems	2-6	56P2523	7-3
printer communication problems	2-4	56P2524	7-3
scanner problems	2-5	56P2525	7-3
system board	5-1	56P2526	7-3
		56P2527	7-3
		56P2529	7-3
		56P2530	7-3
		56P2531	7-3
		56P2532	7-3
		56P2533	7-3
<b>T</b>			
telephone communication	2-18		
theory of mechanism			
contact image sensor	3-2		
document sensors	3-2		
drive feed roller assembly	3-1		
scanner	3-1		

## Part Numbers

11B6073	7-5
11B6074	7-5
11B6076	7-5
11B6078	7-5
12G6968	7-7
13D0400	7-5
13D0401	7-5
13D0402	7-5
13D0403	7-5
14D0630	7-5
14D0632	7-5
56P1040	7-5
56P1168	7-7
56P2442	7-5
56P2443	7-5